

# USR-N580 User Manual

File Version: V1.0.1

# Content

Content.....	2
1. Introduction.....	4
1.1 Overview.....	4
1.2 Features.....	4
2. Get started.....	6
2.1 Specifications.....	6
2.2 Hardware.....	8
2.2.1 Dimensions.....	8
2.2.2 Indicators.....	9
2.3 Connecting Hardware.....	9
2.3.1 Serial Connecting.....	9
2.3.2 Network Connecting.....	9
2.3.3 Power Supply.....	10
3. Utility Configuration.....	10
3.1 Download the Utility.....	10
3.2 Starting the Configuration Utility.....	10
3.2.1 Discovering Your Device Server.....	10
3.2.2 Network Settings.....	14
3.2.3 Serial Port Settings.....	15
3.2.4 Miscellaneous Settings.....	16
3.2.5 Restore to Factory Default Settings.....	16
3.2.6 Update Firmware.....	18
4. Selecting an Operating Mode.....	20
4.1 Overview.....	20
4.2 TCP Client mode.....	21
4.3 TCP Server mode.....	24
4.4 UDP Client Mode.....	26
4.5 UDP Server Mode.....	28
4.6 Httpd Client Mode.....	29
5. General Functions.....	31
5.1 Serial Packaging Mechanism.....	31
5.2 Flow Control.....	31
5.3 RFC2217.....	32
5.4 Modbus.....	34
5.5 Heartbeat Packet.....	39
5.6 Registry Packet.....	42
5.7 Short Connection.....	43
5.8 Uart Cache.....	44
5.9 UDP Multicast.....	45
5.10 Web Socket.....	48

---

5.11 Network Printing Function.....	52
6. Virtual Com Software.....	54
7. USR Cloud Platform.....	55
8. AT Command Set.....	55
9. Disclaimer.....	56

# 1. Introduction

## 1.1 Overview

USR-N580-H7 module is designed to realize bidirectional data transparent transmission between the serial port and the Ethernet port. User does not need to care about the specific details, the module completes the protocol conversion internally. The serial port side is the RS485 level data, and the Ethernet port side is the network data packet. The USR-N580 device server is rugged, user-friendly, making simple and reliable serial to Ethernet solutions possible. There are two ways to access the configuration settings: web page, Windows utility.

## 1.2 Features

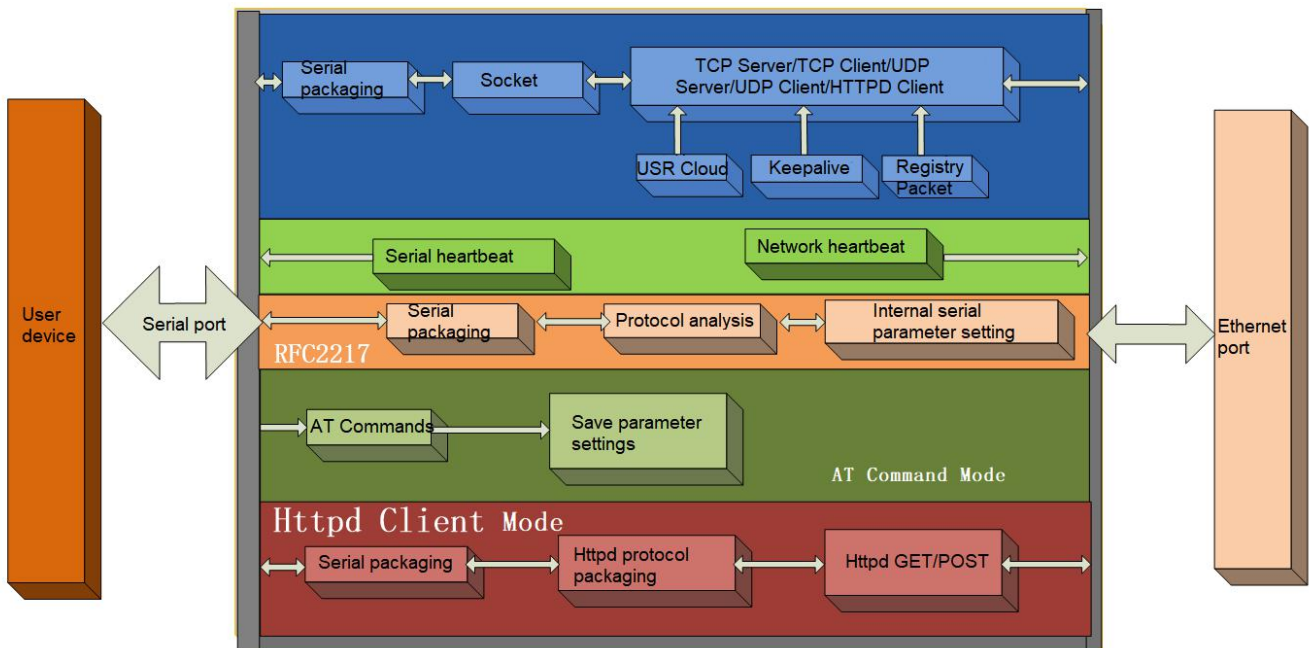

- New ARM kernel, reliable TCP/IP protocol stack, industrial working temperature range
- Auto-MDI/MDIX, RJ45 port with 10/100Mbps
- Support TCP Server, TCP Client, UDP Client, UDP Server, HTTPD Client working modes
- One serial port supports two socket connections
- Support network printing function
- Functions of Modbus gateway, Modbus RTU to Modbus TCP, Modbus polling.
- Eight serial ports work individually.
- Distinguish which serial port connected via port number
- Support virtual serial port and provide corresponding software USR-VCOM
- Serial baud rate from 600bps to 921.6K bps; Parity of None, Odd, Even
- Support static IP, DHCP, and searching devices within the network through UDP broadcast
- Provide serial and network setting protocol, TCP/IP socket example code
- Built-in web page, configuring the parameters via the web page
- Reload button, one key to restore default settings.
- RJ45 with Link/Data indicator light, built-in isolation transformer and 2 KV electromagnetic isolation
- The global unique MAC address bought from IEEE
- Upgrade firmware via network
- Support DNS function
- Support web port revise (80 by default)
- Keepalive, detect dead links and reconnect rapidly
- Custom username and password, used to page log in and network settings
- Support Websocket, realize bidirectional transparent transmission between web page and any **one** serial port
- 8 serial ports support RS485 communication, indicator lights (TX/RX)
- Power supply in two mode, DC adapter or 5.08-2 terminal pin
- UDP broadcast function, can broadcast data to all the IP in the same network

## 2. Get started

### 2.1 Specifications

Classify	Parameter	Value
Hardware Parameters	Operating Voltage	DC 9.0~36.0V
	Operating Current	120mA@12V
	Net interface format	RJ45,10/100Mbps
	Serial baud rate	600~921.6K(bps)
	No. of serial ports	RS485*8
Software parameters	Net protocol	IPV4, TCP/UDP, HTTP
	IP mode	Static IP, DHCP
	DDNS	supports
	User Configuring	Software/webpage configuring, serial/network AT commands
	Operation mode	TCP server, TCP client, UDP server, UDP client Support two-way socket
	Similar RFC2217	support
	HTTPD client	support
	TCP server	Support up to 8 TCP Clients (user-defined)
	Net buffer	48Kbyte
	Serial buffer	Dynamic packet buffer E.g: When the packet length is 10Byte, can buffer 200 packets (2KB). When the packet length is 1460Byte, can buffer 5 packets (7.3KB).
	Average delay	<10ms
	Related software	USR-VCOM, set-up software
	485_EN switching speed	<100us
	Flow control	XON/XOFF
	Registration packet	User-defined, MAC, USR Cloud
Web to serial	Websocket function	
Heartbeat packet	UART, NET	
Others	Hardware protection	Electrostatic protection ESD: level 3 Anti-surge: level 3 Pulse group: level 3
	Dimension	222*122*35mm(L*W*H With terminal, ears)
	Operating temperature	-40~+85°C

	Storage temperature	-40~105°C
	Operating humidity	-40~+85°C (Industrial)
	Storage humidity	-45~105°C, 5~95%RH (non-condensing)
	Accessories	Power adaptor, Ethernet cable
	Packaging	Electrostatic bubble

## 2.2 Hardware

### 2.2.1 Dimensions

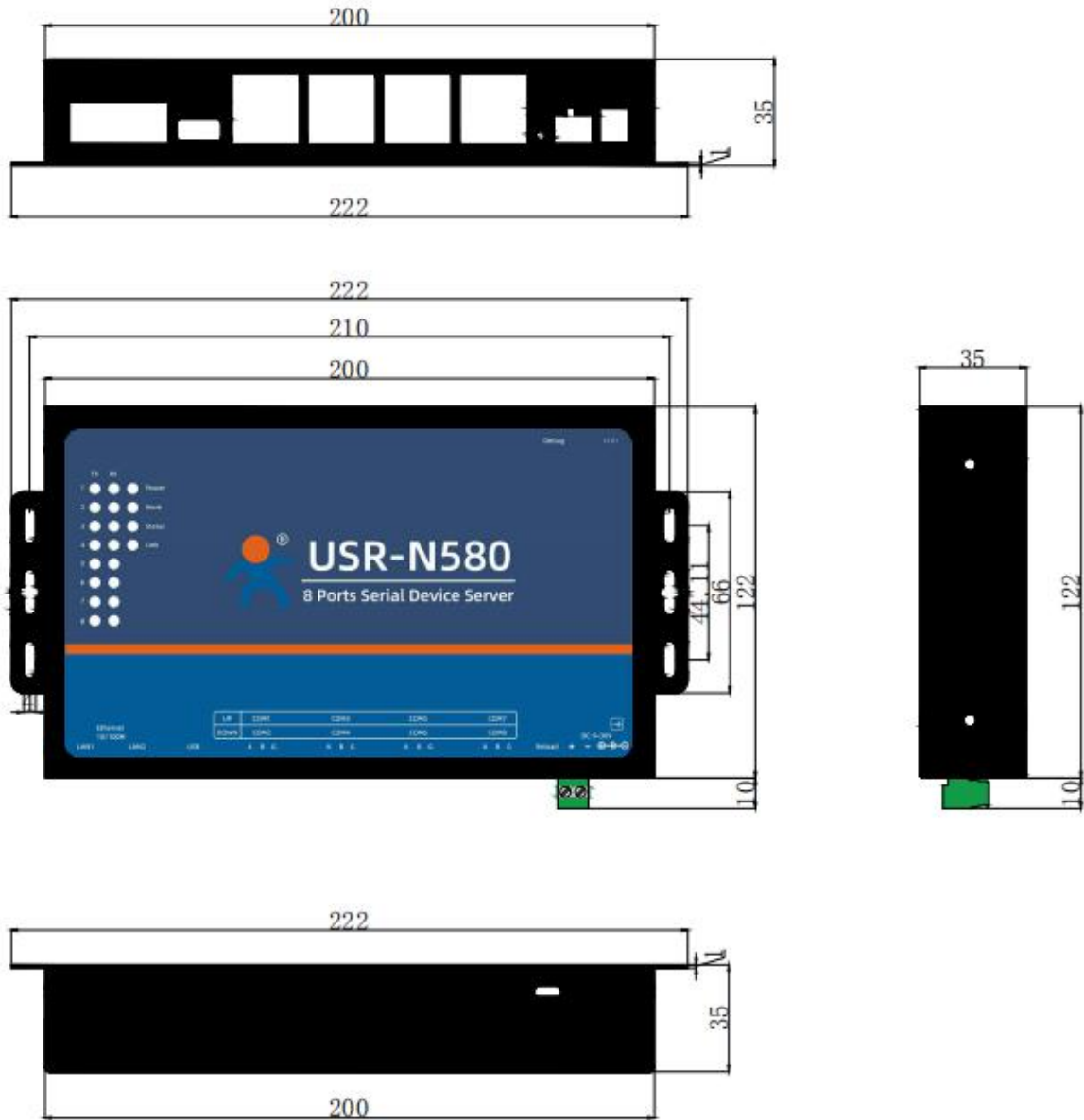



## 2.2.2 Indicators



Indicator	Description
Power	Indicates power. It is on when power is supplied
Work	Indicates working status. It twinkles when N580 works well. If it is on or off for a period, N580 works improperly, you should disconnect the power and restart.
TX n	It twinkles when port n sends data.
RX n	It twinkles when port n receive data.
Status	Error indicator.
Link	Always on when establish a socket connection.

## 2.3 Connecting Hardware

### 2.3.1 Serial Connecting

Connect a serial data cable between the N580 and the serial device. And the pin wiring should be: A to A, B to B, GND to GND. Please set the serial parameters of N580 to be consistent with RS485 serial device. Serial parameters of N580 default to 115200, NONE, 8, 1.

### 2.3.2 Network Connecting

Connect one of the Ethernet cable to the N580's 10/100M Ethernet port and the other end of the cable to the Ethernet network. The green indicator light will always be on and the orange light will be twinkling.

USR-N580 has two Ethernet ports that can be used to cascade other devices like a switch.

### 2.3.3 Power Supply

Connect the power adaptor with the N580's power input. If the power is properly supplied, the "Power" LED will show a solid red color and the "Work" LED will show a twinkling green color.

## 3. Utility Configuration

### 3.1 Download the Utility

Be sure you have administrative privileges and disable any firewall/anti-virus software when installing software.

Configuration utility download address:

### 3.2 Starting the Configuration Utility

#### 3.2.1 Discovering Your Device Server

USR-N580 defaults to a static IP address 192.168.0.7, you can set the computer to a static IP address that in the same network segment with N580, like 192.168.1.201. Then directly connect the Ethernet port of N580 to the computer via a Ethernet cable.

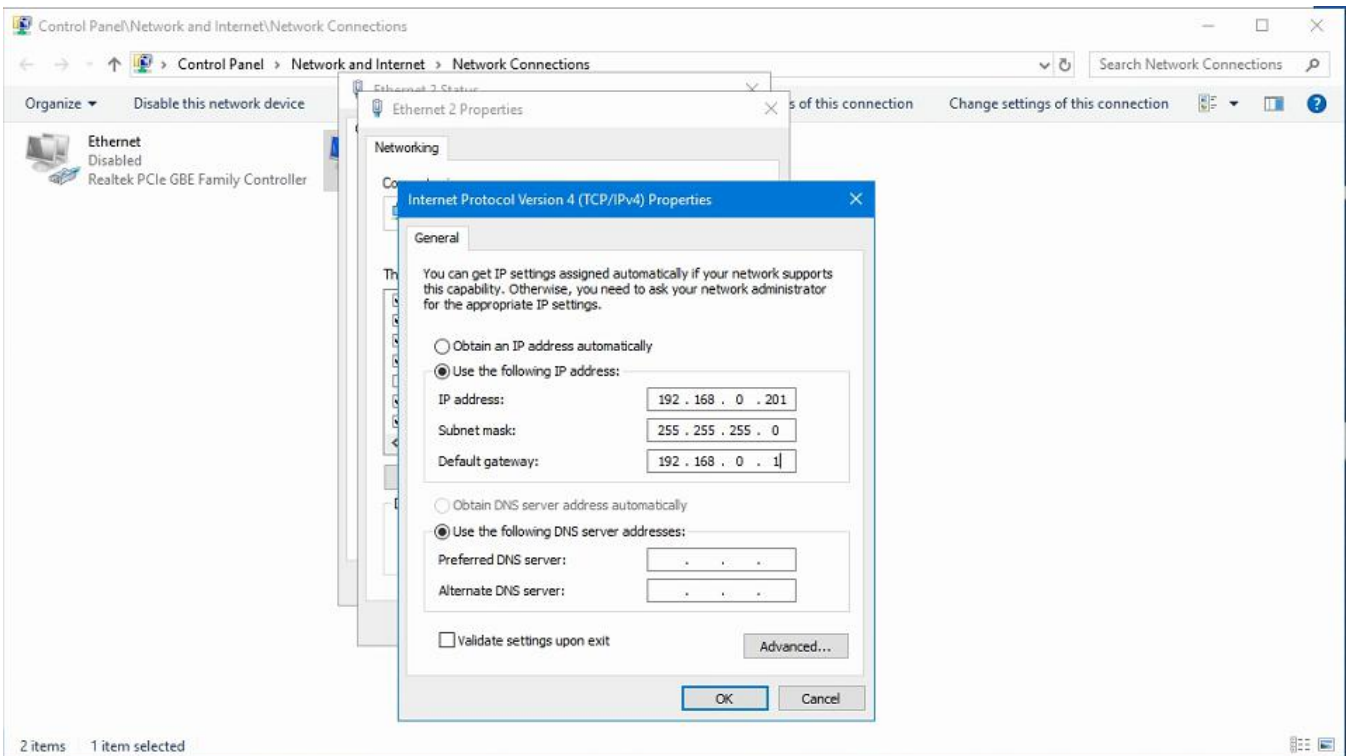

In Ethernet Tool, click **Search** to search your LAN for N580 device servers. The configuration screen will show the N580 devices that were found on the LAN.

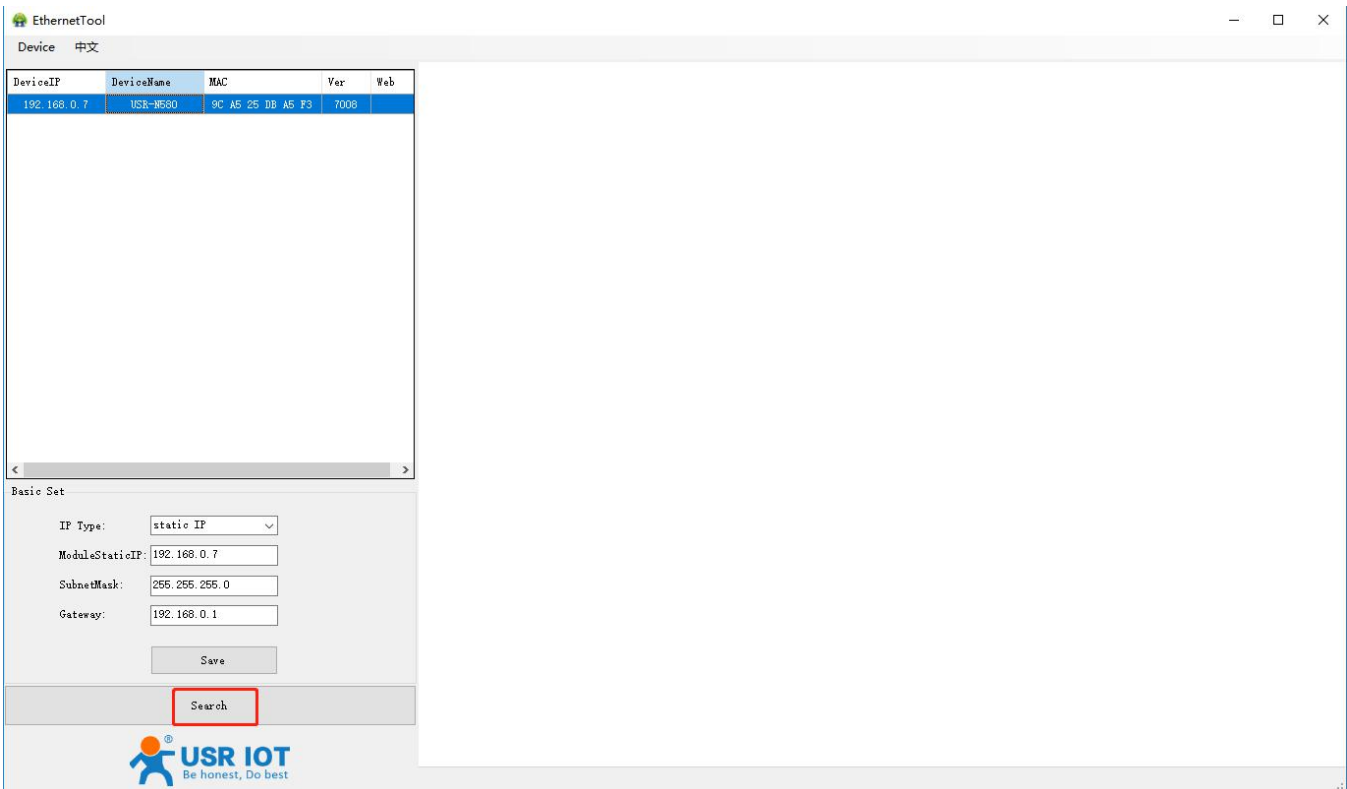

1. Double-click the device name field, enter the default username (admin) and password (admin) to log in to the device's web page.

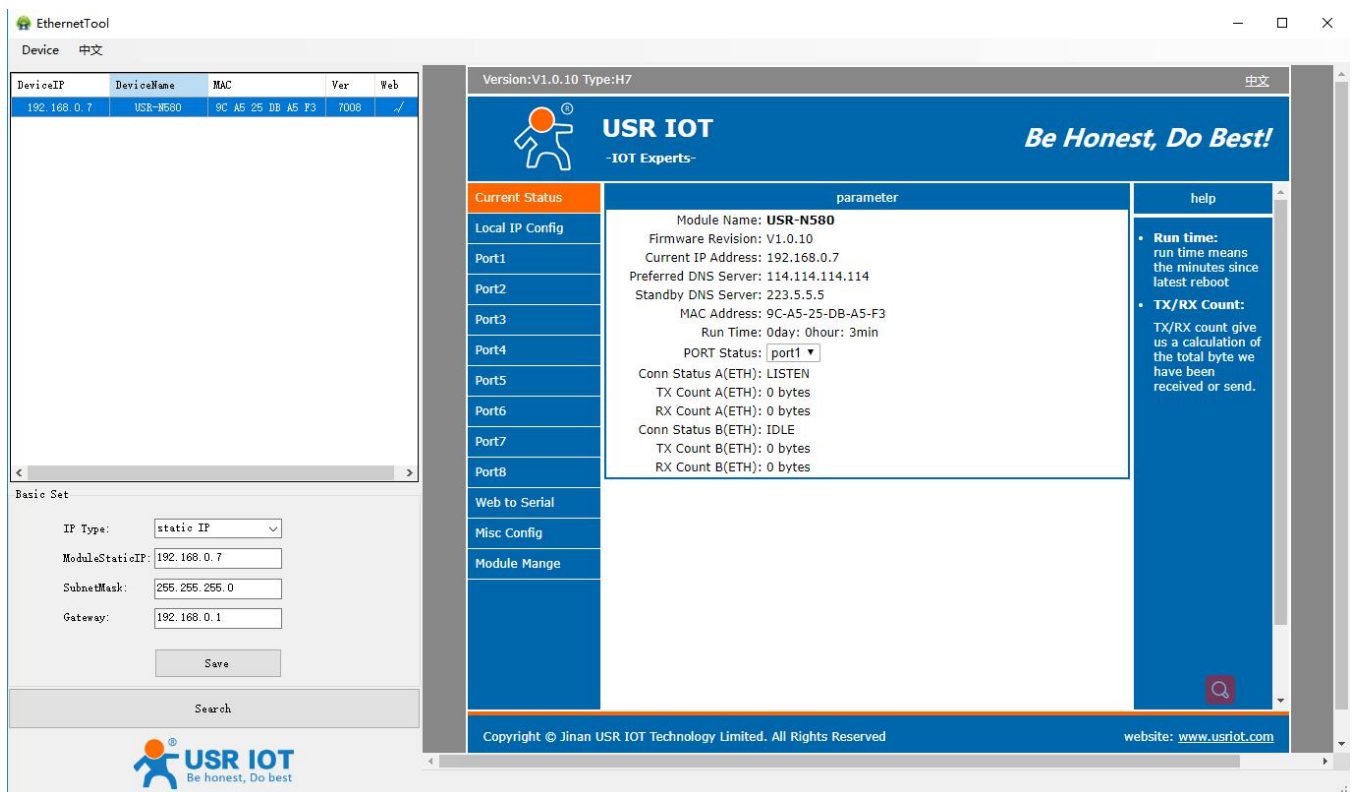
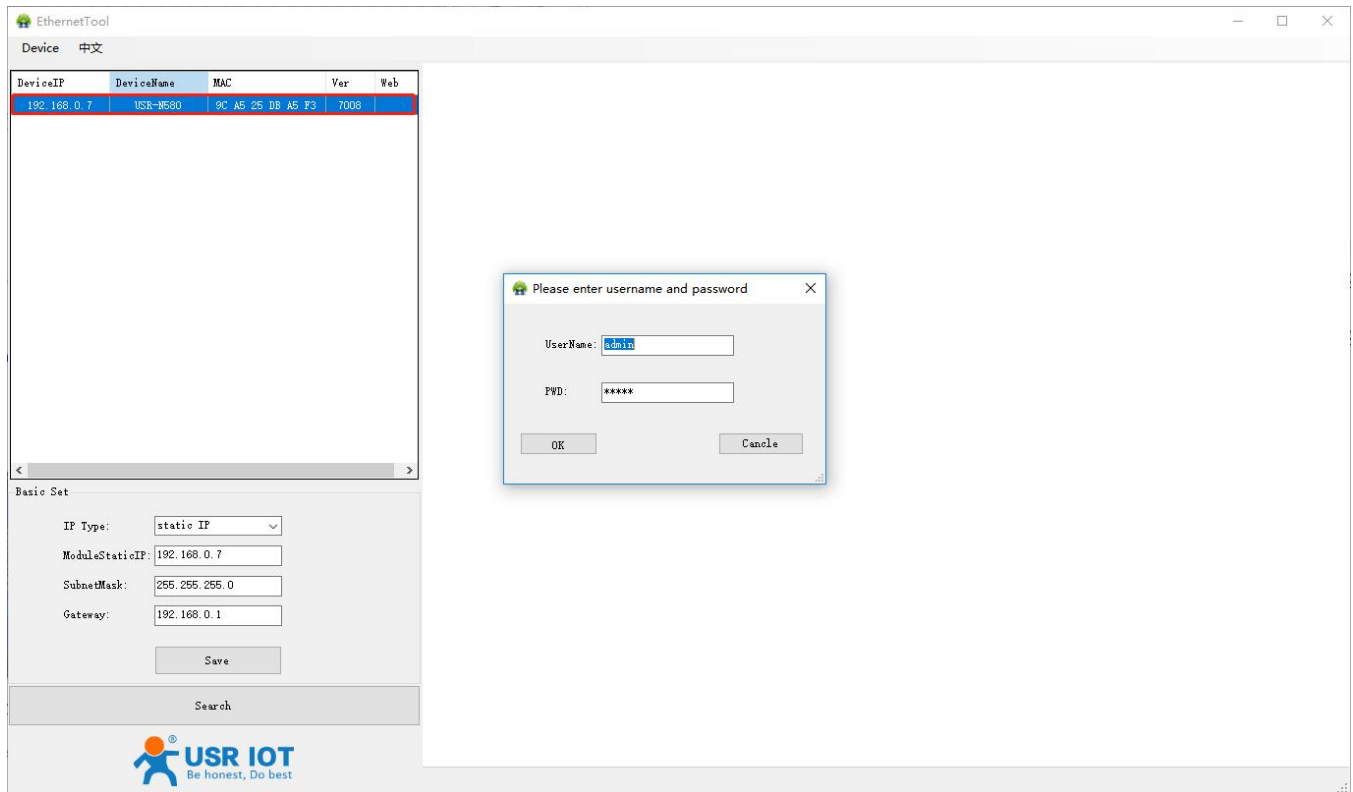

2. Or you can right click the device name to directly log in to its webpage.

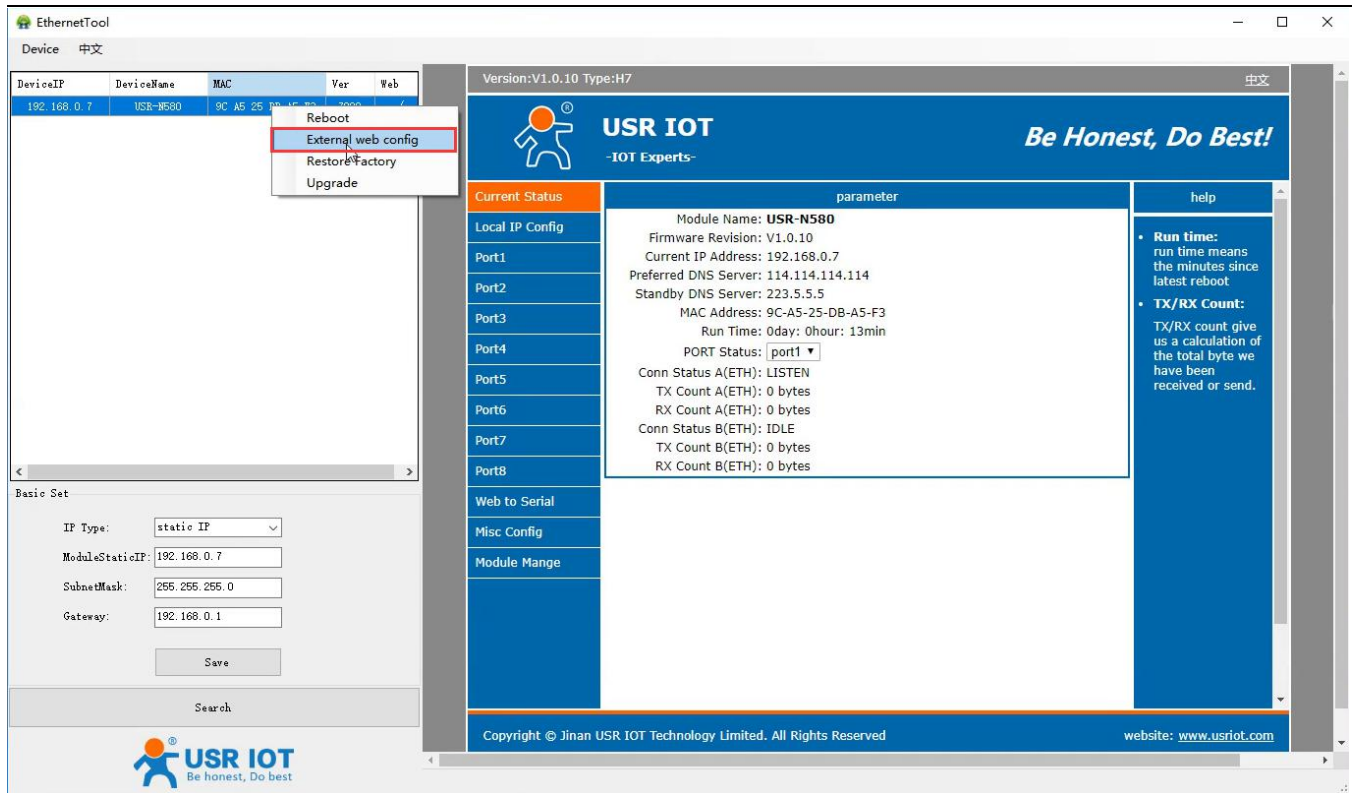

EthernetTool

Device 中文

DeviceIP	DeviceName	MAC	Ver	Web
192.168.0.7	USR-N580	9C-A5-25	V1.0.10	192.168.0.7

Reboot  
External web config  
Restore Factory  
Upgrade

Version: V1.0.10 Type: H7 中文

**USR IOT**  
-IOT Experts-  
*Be Honest, Do Best!*

Current Status	parameter	help
Local IP Config	Module Name: <b>USR-N580</b> Firmware Revision: V1.0.10 Current IP Address: 192.168.0.7 Preferred DNS Server: 114.114.114.114 Standby DNS Server: 223.5.5.5 MAC Address: 9C-A5-25-DB-A5-F3 Run Time: 0day: 0hour: 13min	<ul style="list-style-type: none"> <li><b>Run time:</b> run time means the minutes since latest reboot</li> <li><b>TX/RX Count:</b> TX/RX count give us a calculation of the total byte we have been received or send.</li> </ul>
Port1	PORT Status: port1	
Port2		
Port3		
Port4		
Port5	Conn Status A(ETH): LISTEN TX Count A(ETH): 0 bytes RX Count A(ETH): 0 bytes	
Port6		
Port7	Conn Status B(ETH): IDLE TX Count B(ETH): 0 bytes RX Count B(ETH): 0 bytes	
Port8		
Web to Serial		
Misc Config		
Module Mange		

Basic Set

IP Type: static IP

ModuleStaticIP: 192.168.0.7

SubnetMask: 255.255.255.0

Gateway: 192.168.0.1

Save

Search

Copyright © Jinan USR IOT Technology Limited. All Rights Reserved website: [www.usriot.com](http://www.usriot.com)

## 3.2.2 Network Settings

The device server must be assigned a unique IP address that is valid for your network. Both fixed and dynamic IP addresses are supported.

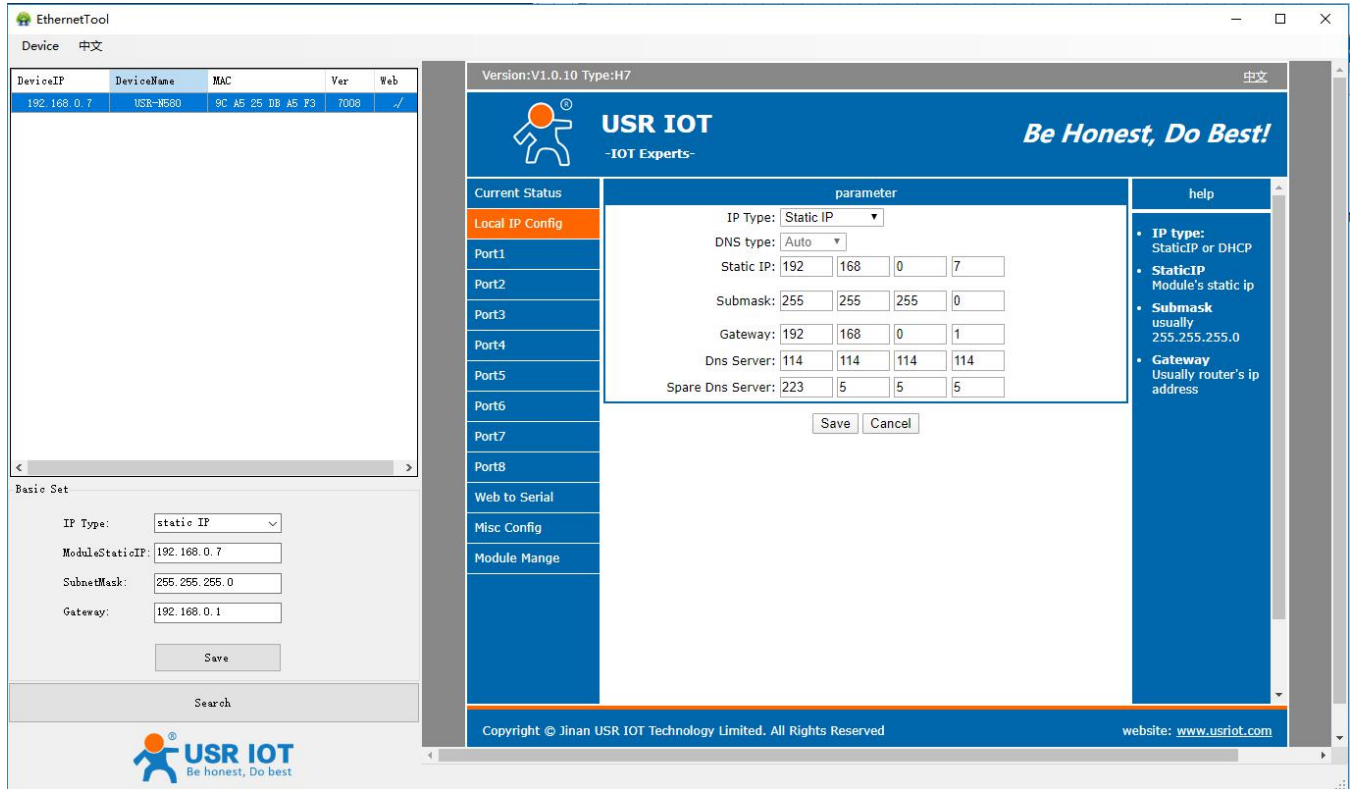

### ➤ Static IP address

To assign a fixed IP address, the **IP Type** must be set to **Static IP**. You also need to modify the **Static IP** address, **Submask**, **Gateway** and **DNS** parameters. Make sure that the IP address is different from other network devices in the LAN.

### ➤ DHCP

Instead of assigning N580 device's IP address, you will need to configure the device to get its IP address from the appropriate server. Set the **IP Type** to **DHCP**, then the IP address and other parameters will be assigned automatically. In this mode, cannot directly connect the device to the computer.

If the device has been configured correctly, you should be able to ping its IP address from the PC.

### 3.2.3 Serial Port Settings

The following serial port parameters need to be set correctly according to your serial device to ensure proper communication.

Parameter	Setting	Default	Description
Baud rate	600~921600bps (User defined)	115200bps	Data transmission rate.
Data bits	7, 8	8	The size of each data character.
Stop bits	1, 2	1	The size of the stop character.
Parity	NONE, EVEN, ODD	NONE	Even and Odd parity provide rudimentary error checking.
Flow control	NFC, FCR (Software flow control)	NFC	Suspend and resume data transmission to ensure that data is not lost.

Serial parameters can be set in **Port** interface:

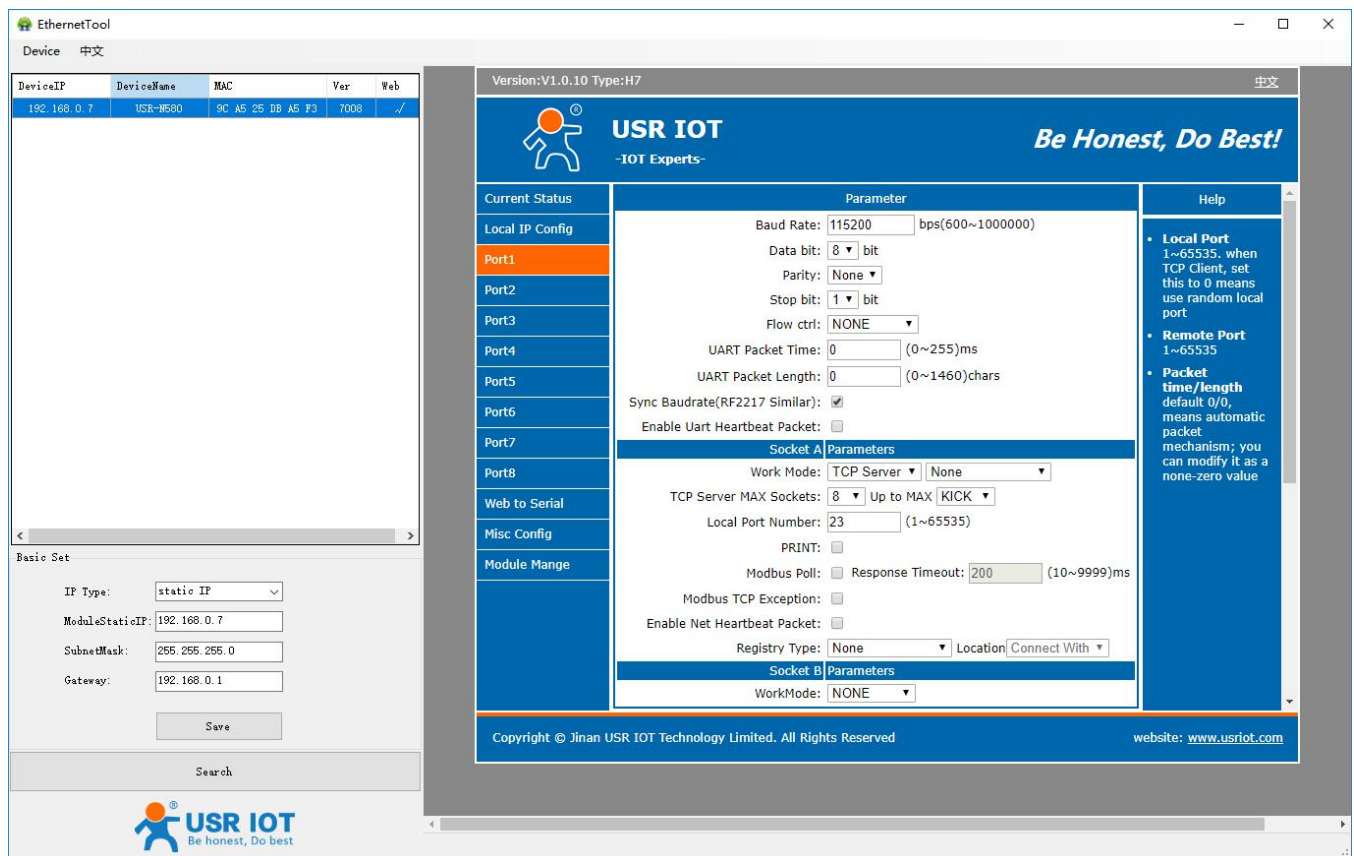

The screenshot shows the EthernetTool software interface. On the left, there is a table of devices with columns for DeviceIP, DeviceName, MAC, Ver, and Web. Below this is a 'Basic Set' section for IP configuration. The main part of the interface is the 'Port1' configuration page, which includes a sidebar with navigation options like 'Current Status', 'Local IP Config', 'Port1', 'Port2', etc. The main content area is titled 'Parameter' and contains the following settings:

- Baud Rate: 115200 bps(600~1000000)
- Data bit: 8 bit
- Parity: None
- Stop bit: 1 bit
- Flow ctrl: NONE
- UART Packet Time: 0 (0~255)ms
- UART Packet Length: 0 (0~1460)chars
- Sync Baudrate(RF2217 Similar):
- Enable Uart Heartbeat Packet:
- Socket A Parameters:
  - Work Mode: TCP Server | None
  - TCP Server MAX Sockets: 8 Up to MAX | KICK
  - Local Port Number: 23 (1~65535)
  - PRINT:
  - Modbus Poll:  Response Timeout: 200 (10~9999)ms
  - Modbus TCP Exception:
  - Enable Net Heartbeat Packet:
  - Registry Type: None | Location | Connect With
- Socket B Parameters:
  - WorkMode: NONE

On the right side of the configuration page, there is a 'Help' section with the following text:

- Local Port**  
1~65535, when TCP Client, set this to 0 means use random local port
- Remote Port**  
1~65535
- Packet time/length**  
default 0/0, means automatic packet mechanism; you can modify it as a none-zero value

At the bottom of the interface, there is a copyright notice: 'Copyright © Jinan USR IOT Technology Limited. All Rights Reserved' and the website 'www.usriot.com'.

About how to select the most appropriate **Operation Mode** and the additional information on each operation mode, please refer to [chapter 4](#).

## 3.2.4 Miscellaneous Settings

You can change some basic parameters like **Module name**, **Username** and **Password** in this interface.

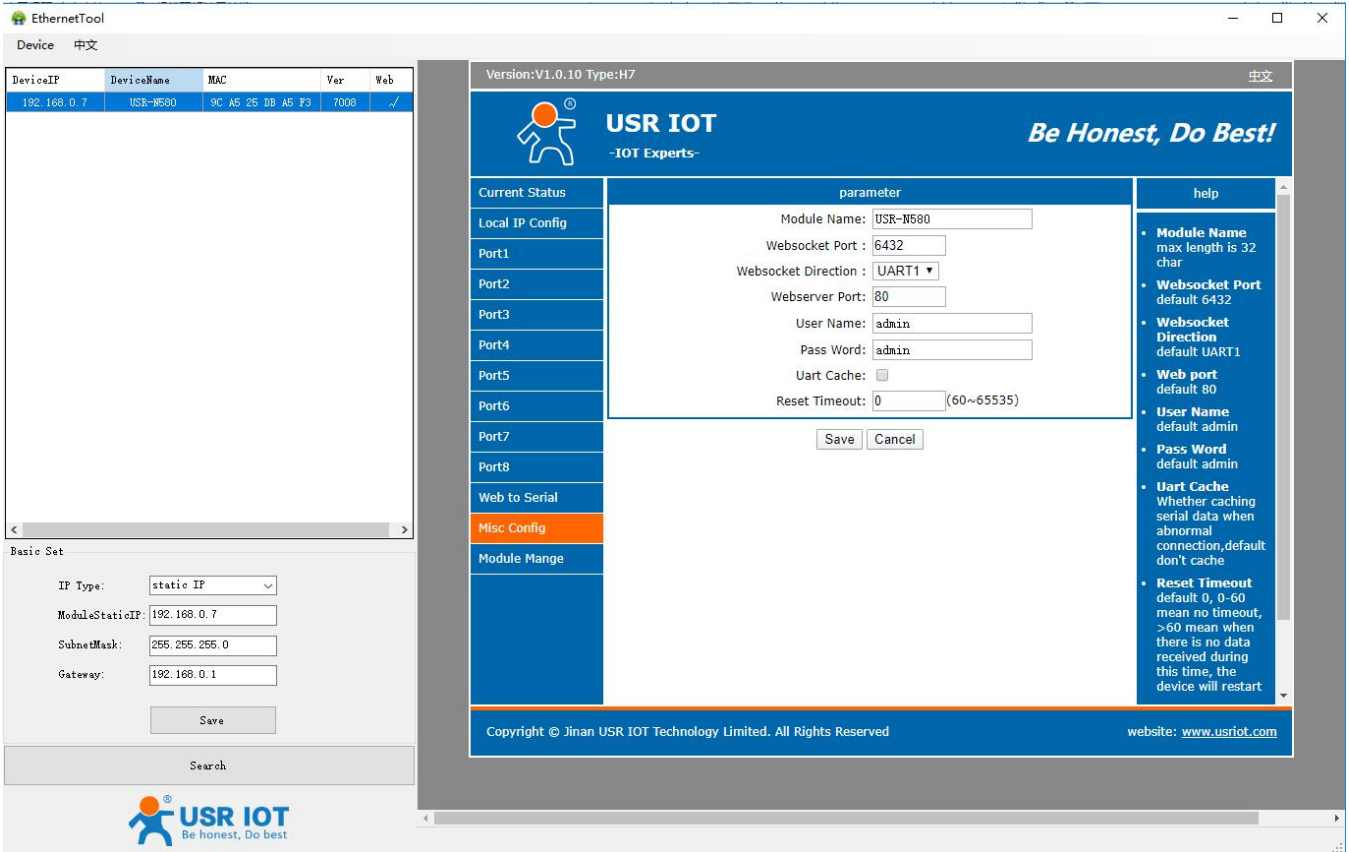

## 3.2.5 Restore to Factory Default Settings

There are three ways to restore the device to factory settings.

1. There is a "Reload" button in the device. After power on, press and hold the "Reload" button for 3~15s to restore the N580 device to factory settings.





2. Restore via web page or configuration utility:

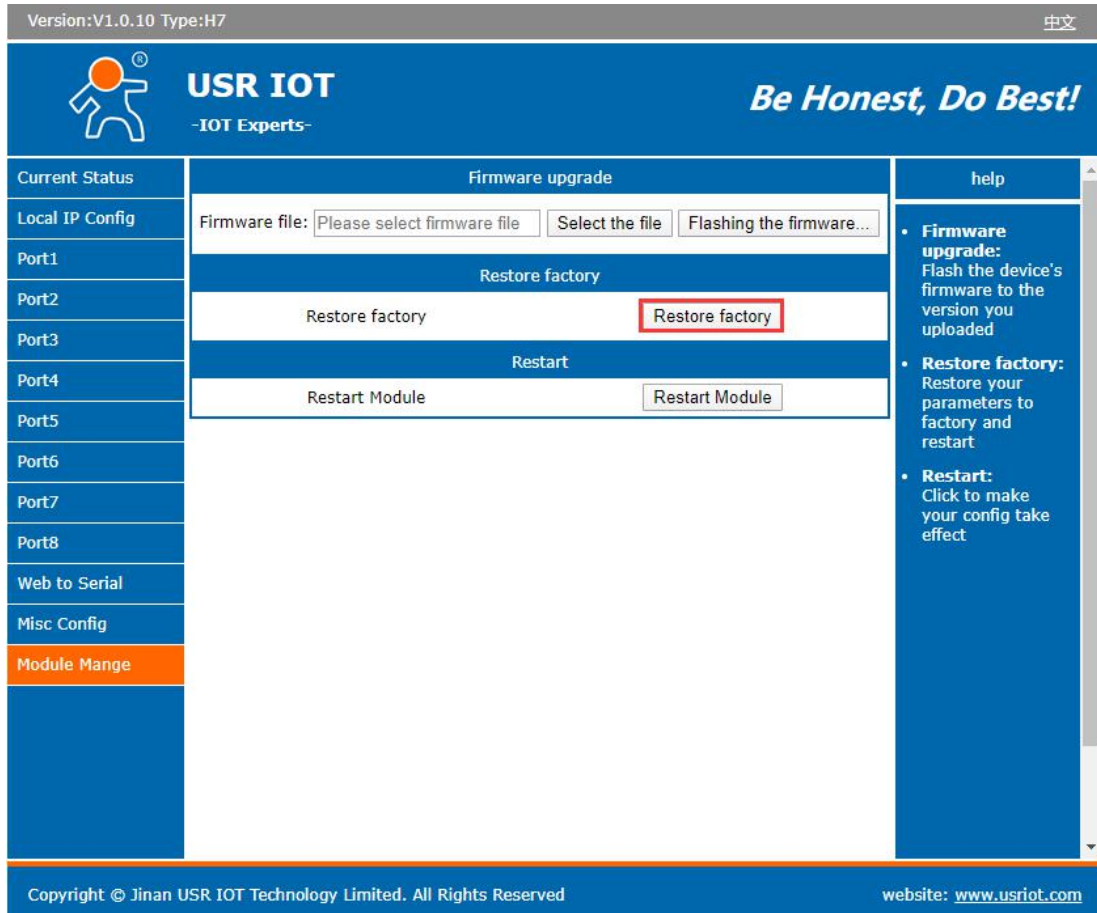

The screenshot shows the USR IOT web configuration utility interface. At the top, it displays 'Version:V1.0.10 Type:H7' and a language selector for '中文'. The main header features the USR IOT logo and the slogan 'Be Honest, Do Best! -IOT Experts-'. On the left, a navigation menu includes 'Current Status', 'Local IP Config', 'Port1' through 'Port8', 'Web to Serial', 'Misc Config', and 'Module Mange' (highlighted in orange). The main content area is divided into three sections: 'Firmware upgrade' with a file selection interface, 'Restore factory' with a 'Restore factory' button highlighted in a red box, and 'Restart' with a 'Restart Module' button. A 'help' sidebar on the right provides instructions for 'Firmware upgrade', 'Restore factory', and 'Restart'. The footer contains copyright information for Jinan USR IOT Technology Limited and the website URL [www.usriot.com](http://www.usriot.com).

Or

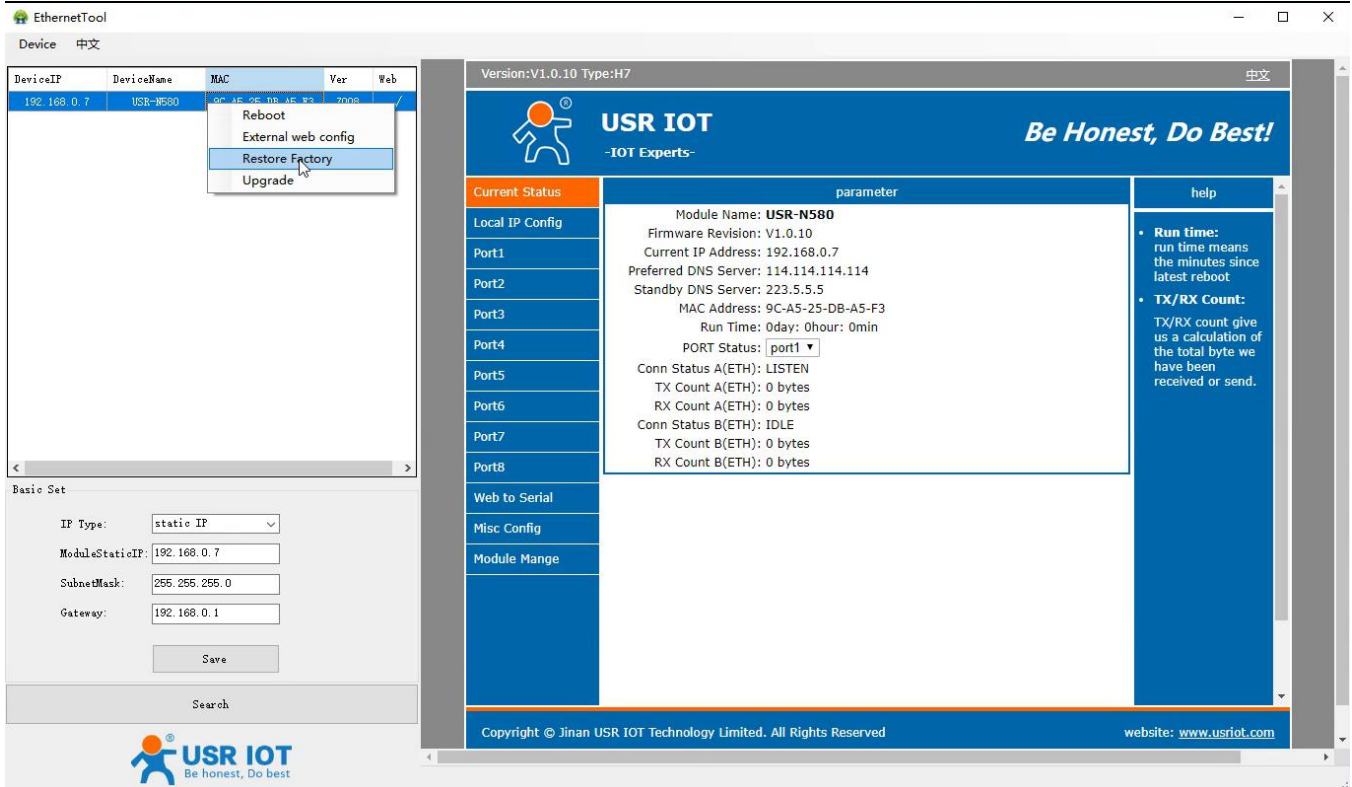

3. Enter AT command mode, send "AT+RELD" from the serial port. For details, please refer to the document: **AT Command Set**.

### 3.2.6 Update Firmware

Firmware updates can be made via webpage or configuration utility. Users can consult with sales or technical support about the firmware. It is best to connect the device directly to the computer when upgrading.

1. After searching the device, right click the device name and select the **Upgrade** to start upgrading the firmware.

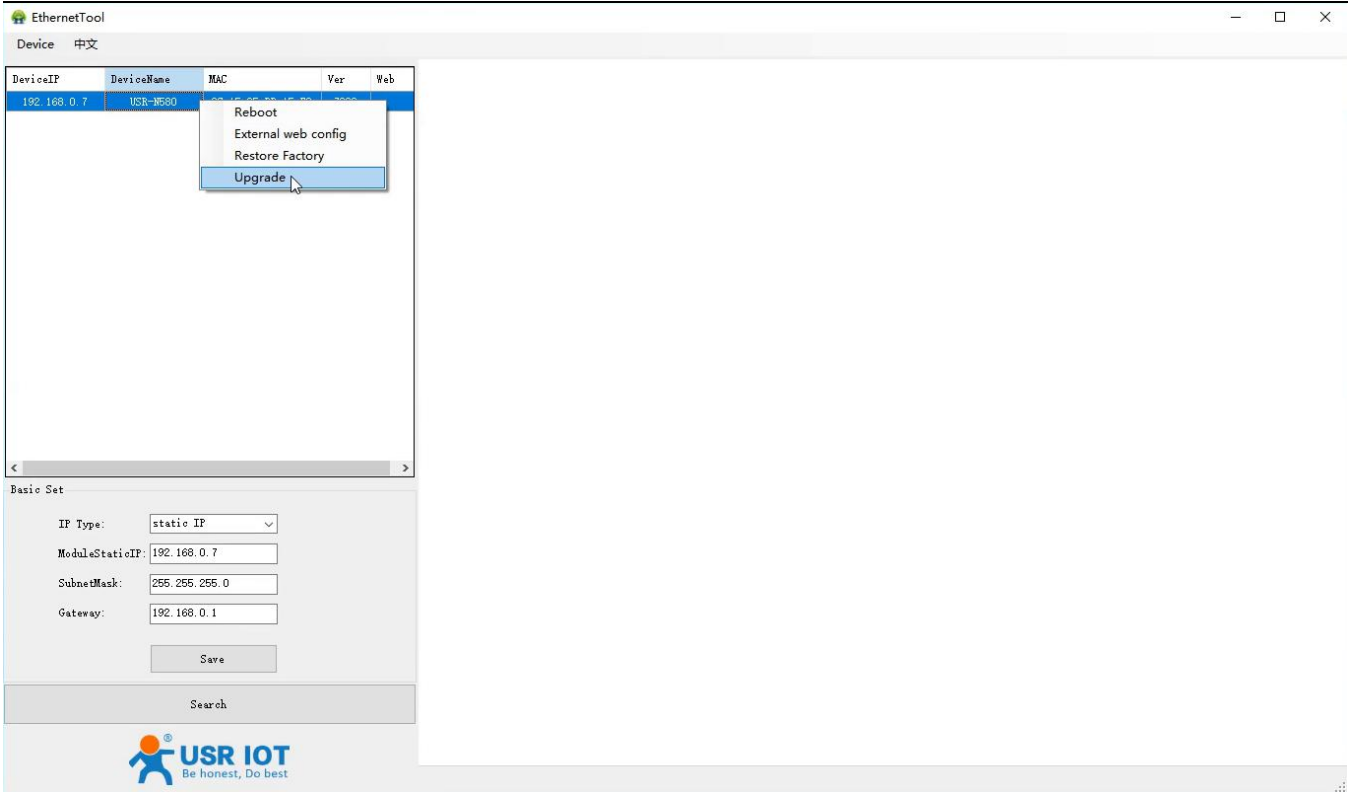

2. Make sure the device and computer are in the same network segment. Select the correct bin file to download.

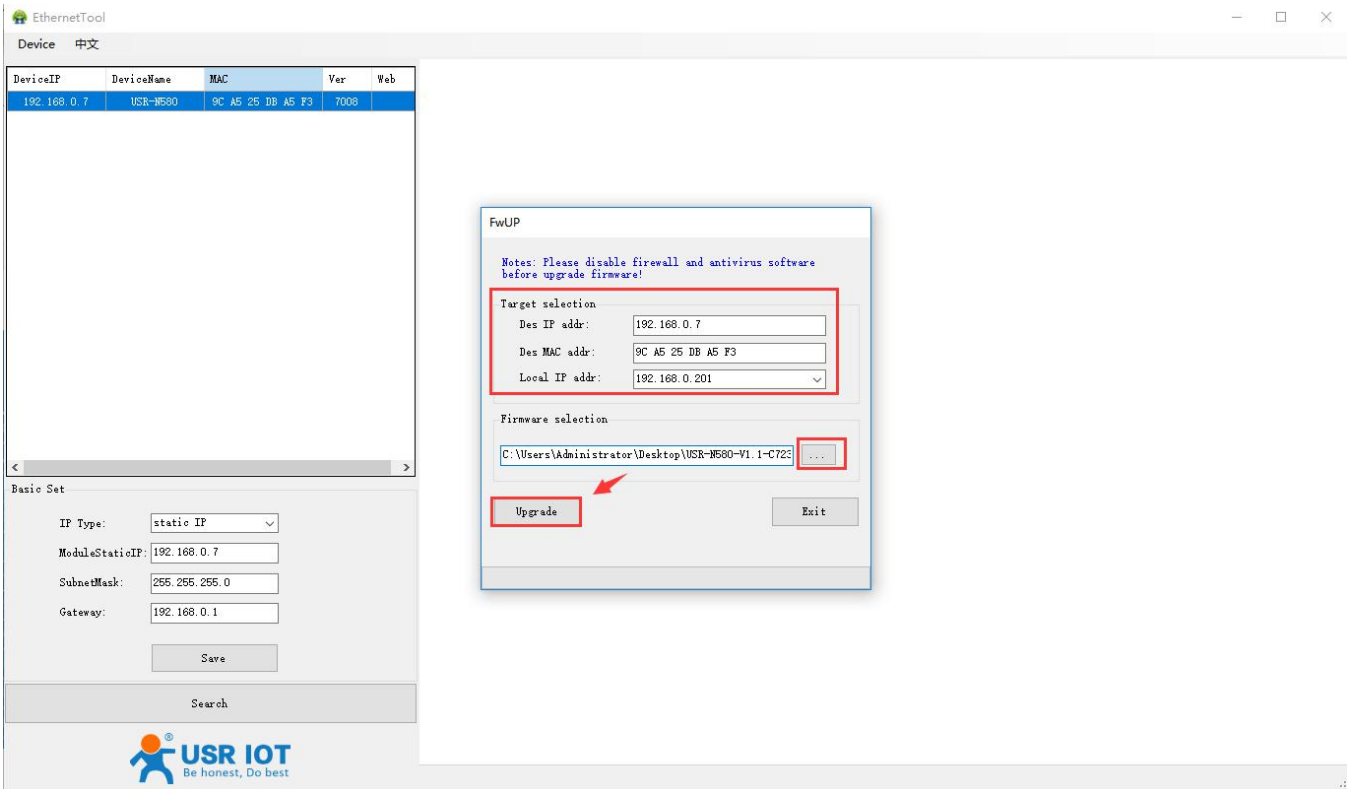

Or

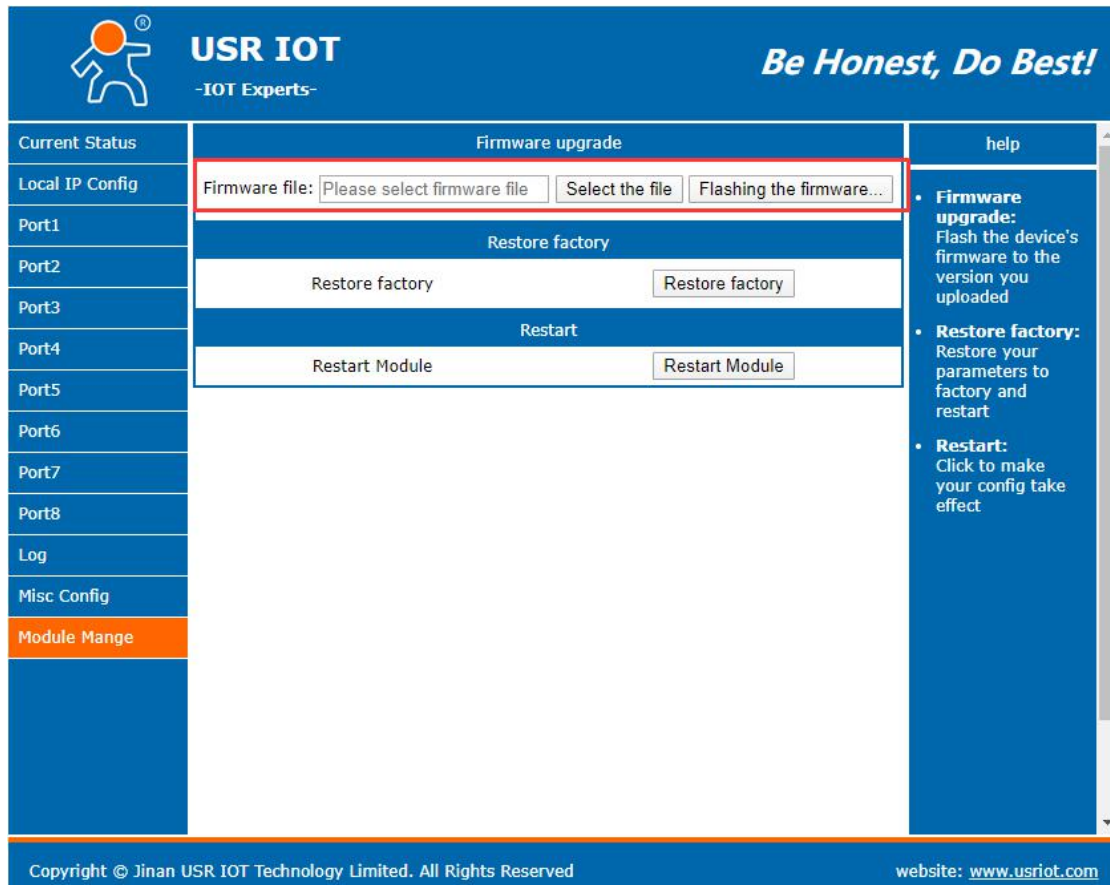

The screenshot displays the USR IOT web interface. The top navigation bar includes the USR IOT logo and the slogan "Be Honest, Do Best!". The main content area is divided into several sections:

- Current Status**: A sidebar menu on the left with options like Local IP Config, Port1-8, Log, Misc Config, and Module Mange (highlighted in orange).
- Firmware upgrade**: The main section, which is highlighted with a red box. It contains a "Firmware file:" label, a file selection button ("Please select firmware file"), a "Select the file" button, and a "Flashing the firmware..." status indicator.
- Restore factory**: A section with a "Restore factory" button.
- Restart**: A section with a "Restart Module" button.
- help**: A sidebar on the right containing instructions for "Firmware upgrade", "Restore factory", and "Restart".

The footer of the interface includes the copyright notice: "Copyright © Jinan USR IOT Technology Limited. All Rights Reserved" and the website URL: "website: [www.usriot.com](http://www.usriot.com)".

## 4. Selecting an Operating Mode

### 4.1 Overview

This chapter covers configuration of a device port's operation mode. Configuring the operation mode for the two sockets via the webpage or AT command.

Socket A: TCP Client, TCP Server, UDP Client, UDP Server, Httpd Client

Socket B: TCP Client, UDP Client

Which operation mode you select will depend on your specific application. For the detailed information of each operation mode, please check below instructions.

## 4.2 TCP Client mode

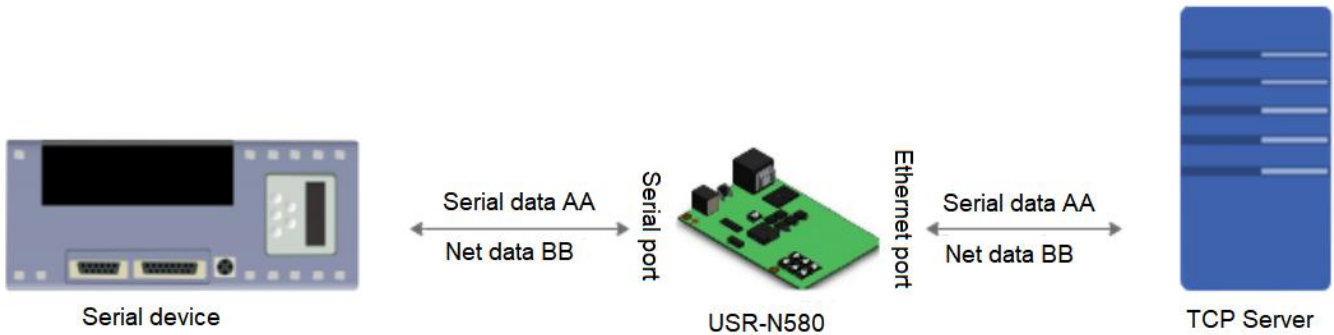

1. In TCP Client mode, USR-N580 can actively establish a TCP connection with a server computer. Once the connection is established, data can be transmitted in both directions between the serial device and the server.
2. Identify disconnects. After connection established, it sends keepalive searching packet every 15 seconds. Once there is an interrupt, it can be detected rapidly then make USR-N540 disconnect from former connection and reconnect.
3. TCP Client mode supports RFC2217, USR Cloud and short connection function.
4. Under the same LAN, please ensure the IP address and gateway are in the same network segment if the N580 is set to a static IP address.
5. In this mode, N580 can connect to the same LAN's IP address or a public IP and domain name.
6. It is recommended to set the local port of N580 to 0 to avoid reconnection failures caused by server determination of connection status anomalies.
7. Test example:
  - Set the N580 to **TCP Client**, **Remote server address**: 192.168.0.201, **Remote port**: 8234. **Save** and **Restart** the device.

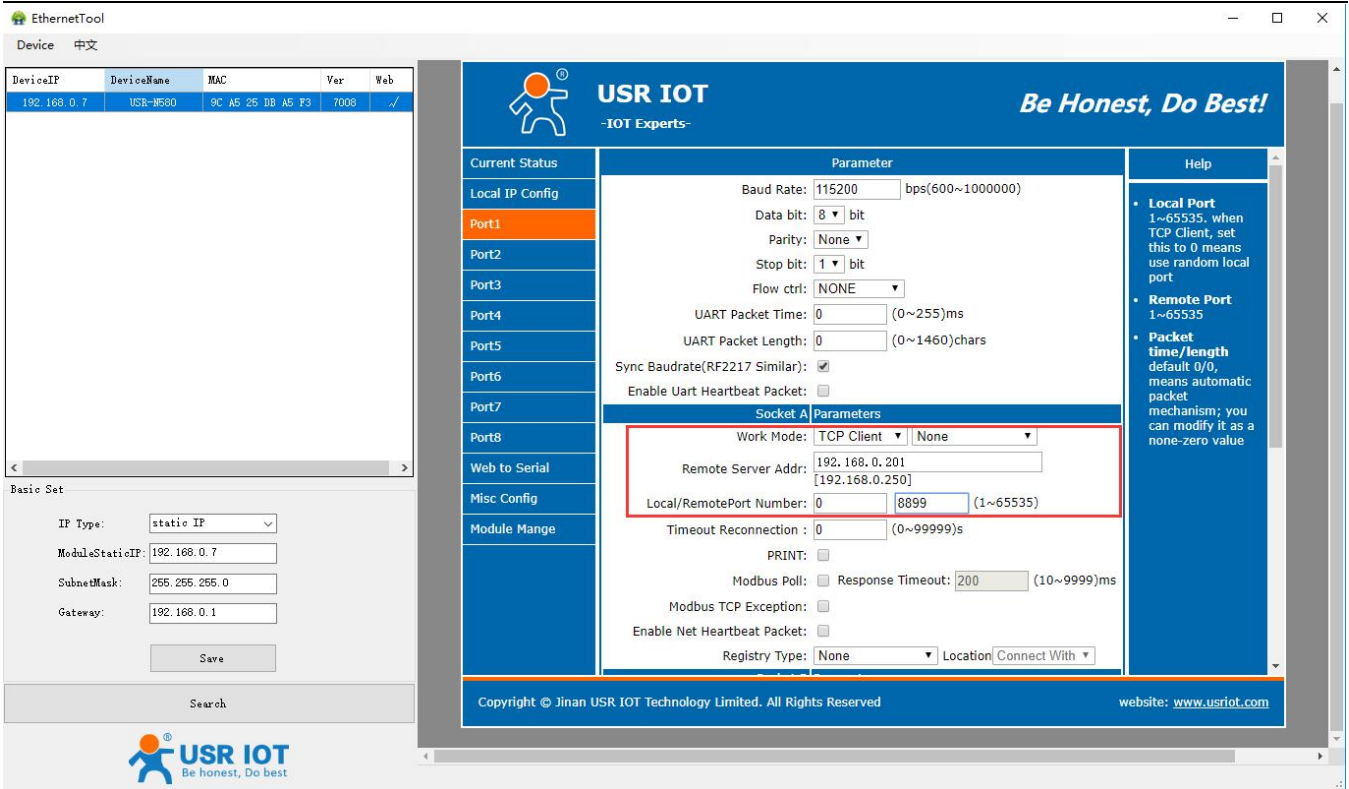

- Open **USR-TCP232-Test** software, set it to TCP server. Local IP is the PC's IP 192.168.0.201, set the local port to 8234. Then click **Listening**. Set the serial parameters same with N580 device.

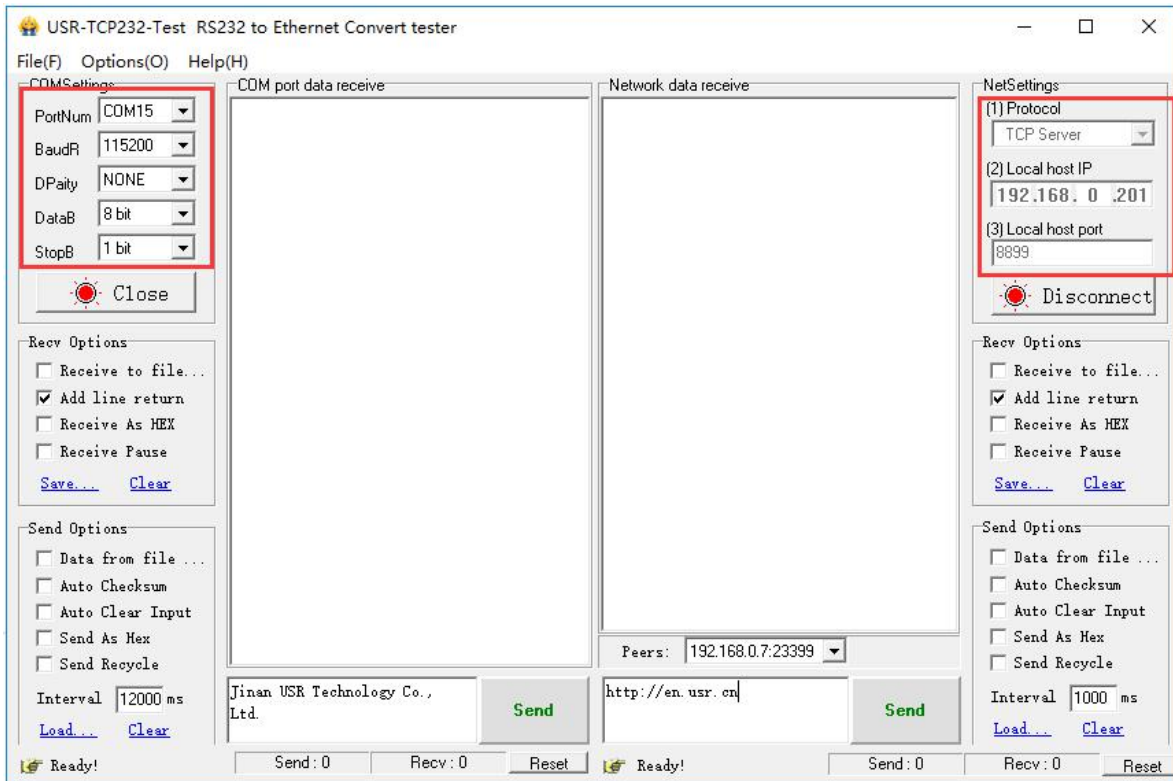

- Data transmission

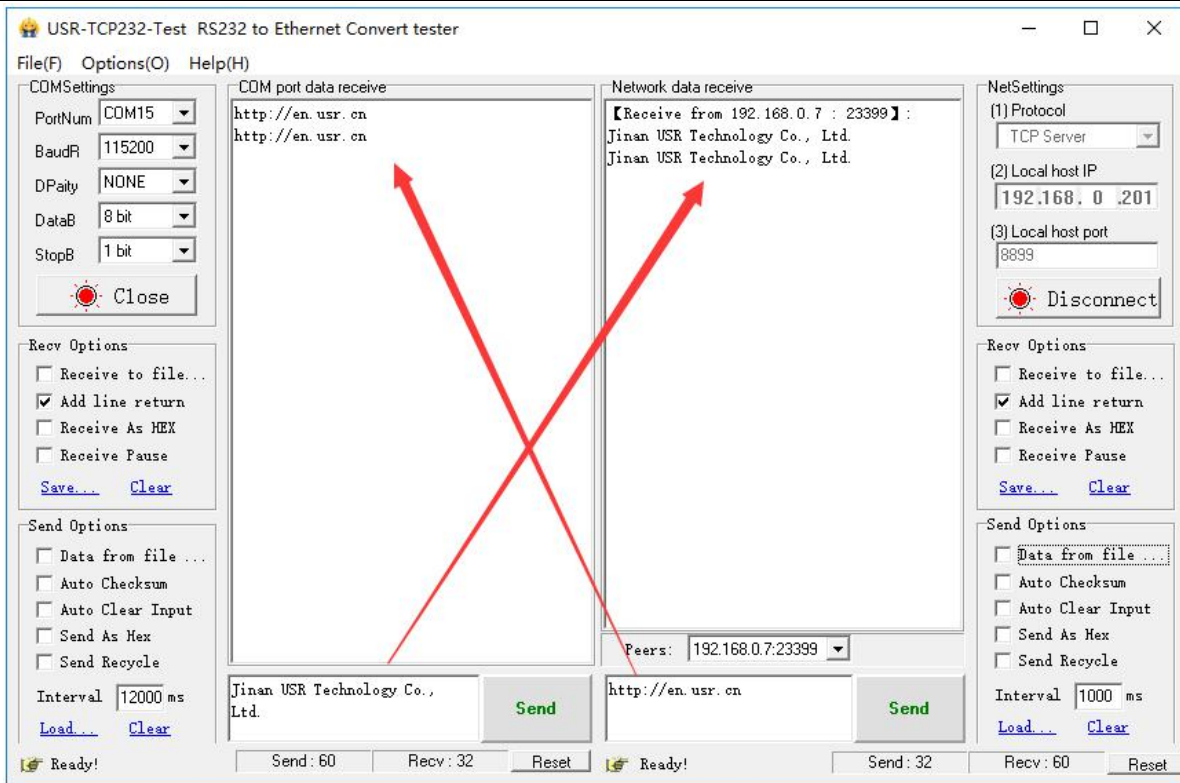

## 4.3 TCP Server mode

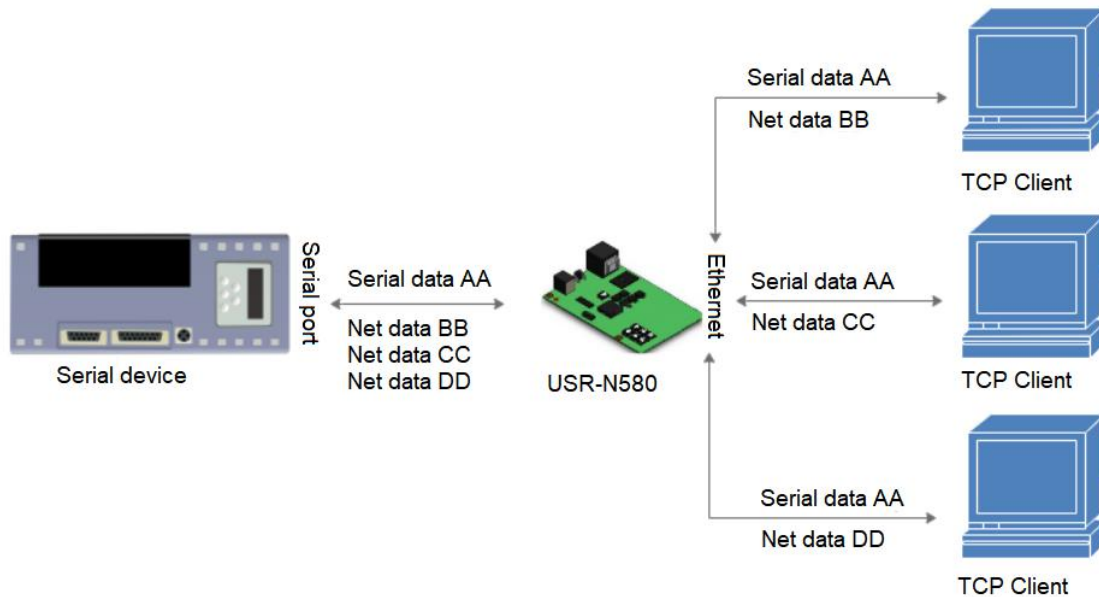

1. In TCP server mode, there is also Keepalive function for real-time monitoring of the integrity of the connection.
2. It is usually used to communicate with TCP clients within the LAN. It is suitable for the scene where there is no server in the LAN and there are multiple computers or mobile phones requesting data from the server.
3. Supports USR similar RFC2217 function.
4. In this mode, N580 actively listens to the set local port, responds to the connection request and creates a TCP connection. When the N580 serial port receives the data, it sends it to all the clients that have established the connection. If access the N580 TCP Server across the public network, you need to do port mapping on the router.
5. TCP server mode also supports up to 8 simultaneous client connections. The local port is a fixed value and cannot be 0.
6. When the number of connected clients exceeds the set maximum, defaults to kick out the old connection from the new connection. You can change this function through the web page.
7. Test example:
  - Set the N580 to **TCP server**, local port to **23**, **Save** and **Restart** the device.



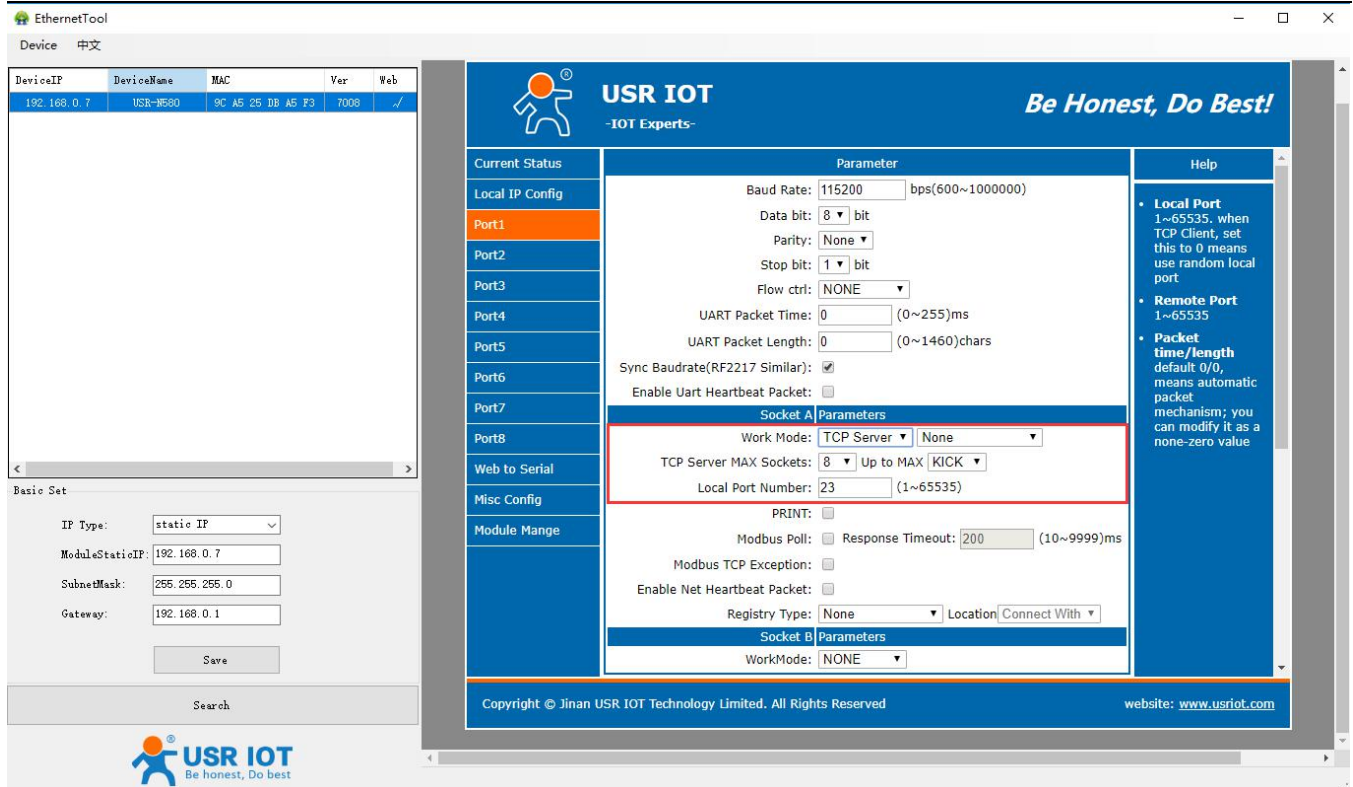

➤ Open **USR-TCP232-Test** software, set it to **TCP Client**, connect to the IP and port of N580. Click **Connect**.

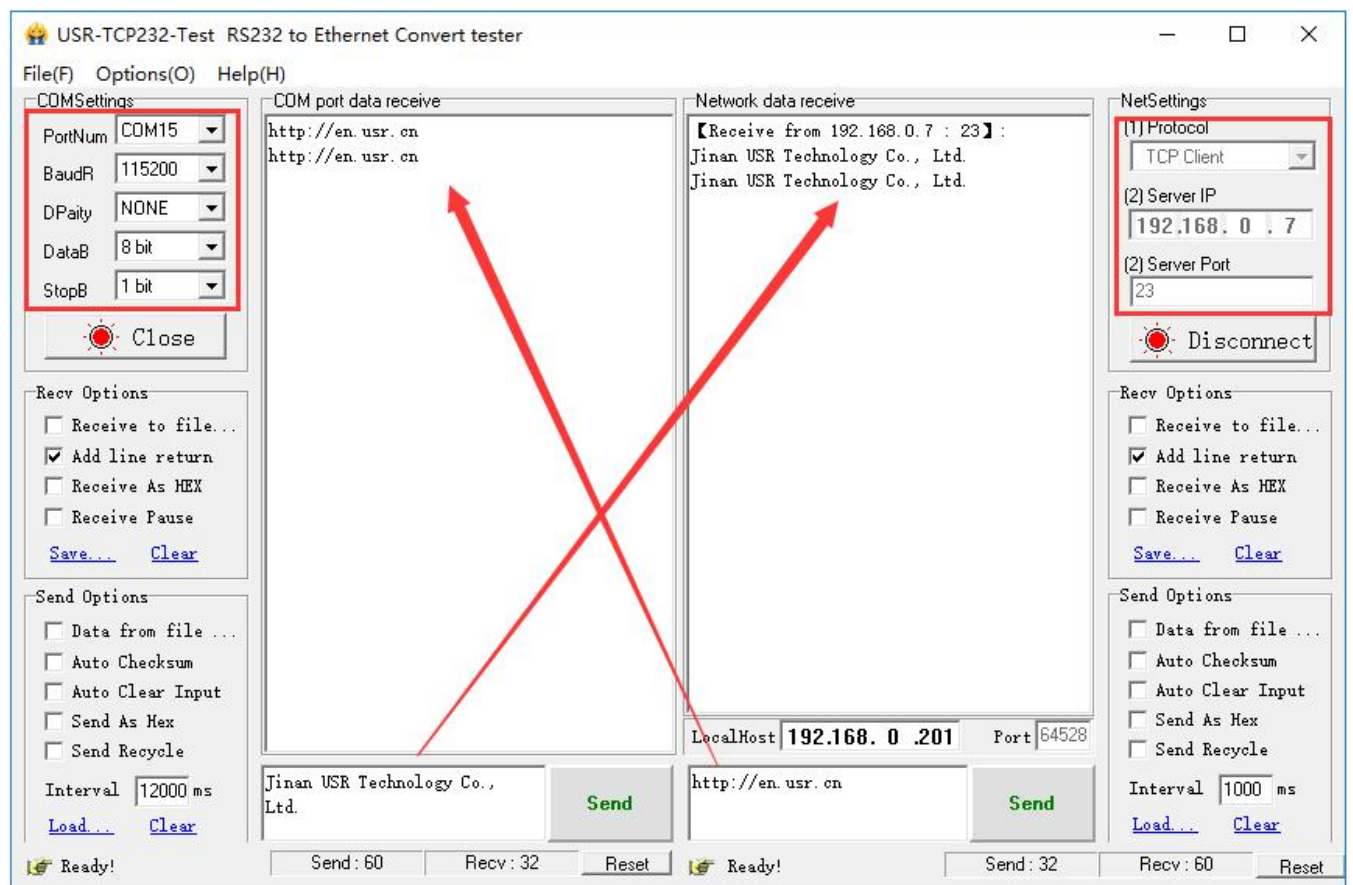

## 4.4 UDP Client Mode

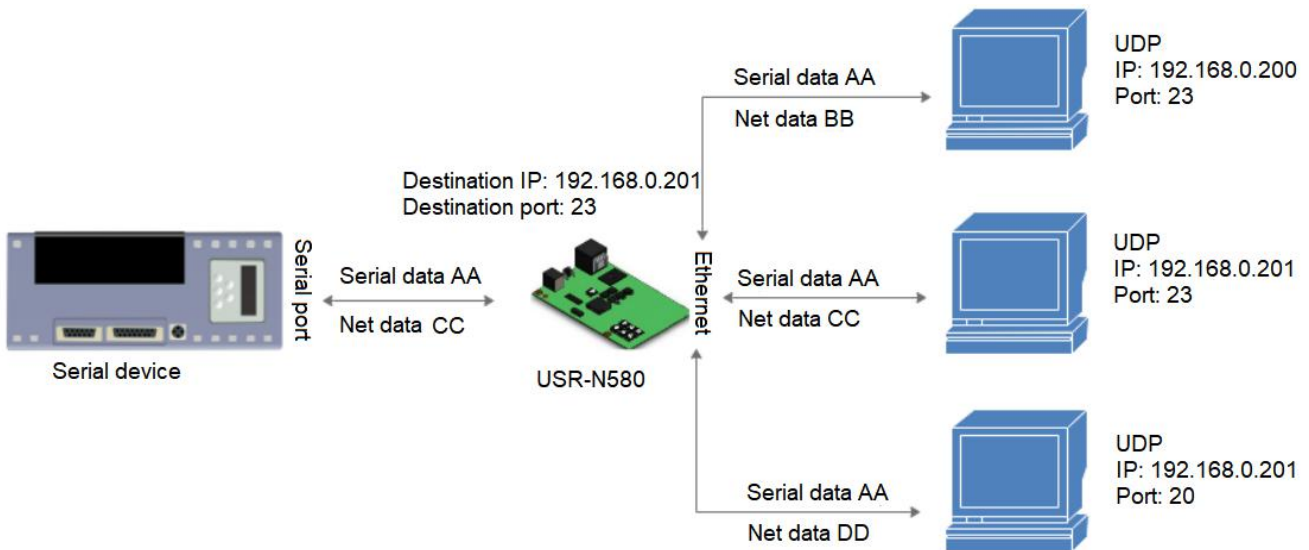

1. In UDP Client mode, N580 will only communicate with the destination IP and port.
2. It is usually used in data transmission scenarios where the packet loss rate is low, the packet is small and the transmission frequency is fast, and the data should be transmitted to the specified IP.
3. Test example:
  - Set the N580 to **UDP Client**, **Remote server address** is the computer's IP, set the **Remote Port** to 8234. Click **Save** then **Restart** the device.

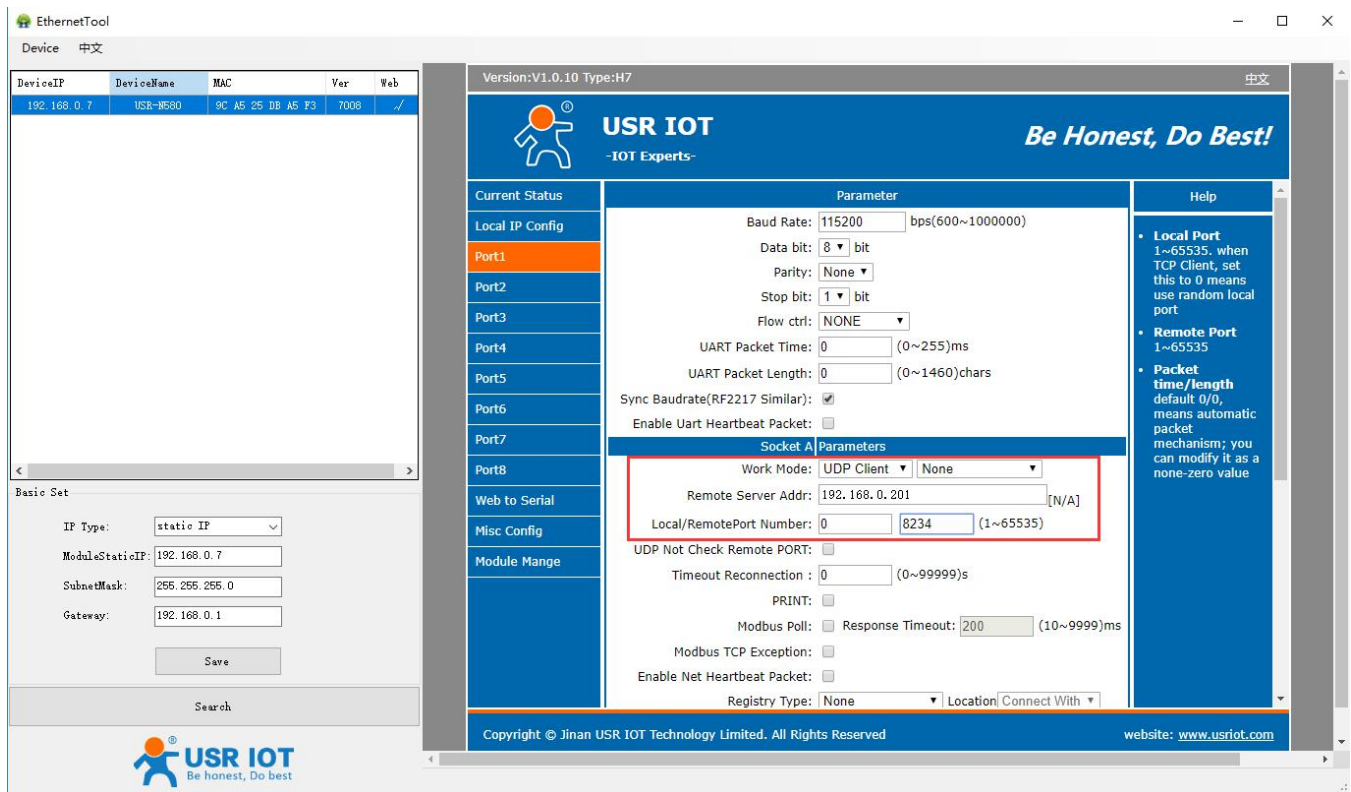

- Open **USR-TCP232-Test**, set it to **UDP** mode, **Local host IP** is the PC's IP, **Local host port** is the **Remote port** of N580 device. Click **Connect**.

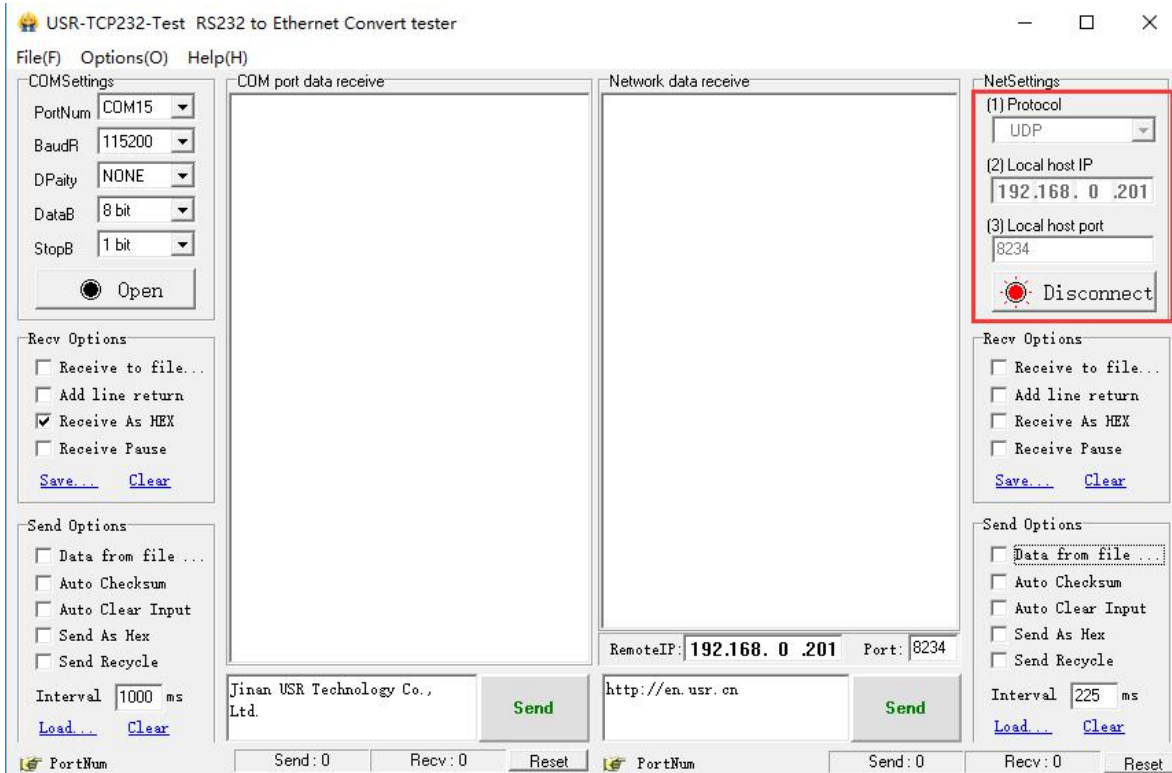

- Click to open the serial port, first send data from the serial port. After receiving the data, the **Remote IP** and **Port** number of the test software becomes the **Local IP** and **Port** of N580. Then can also send data from network side to the serial port.

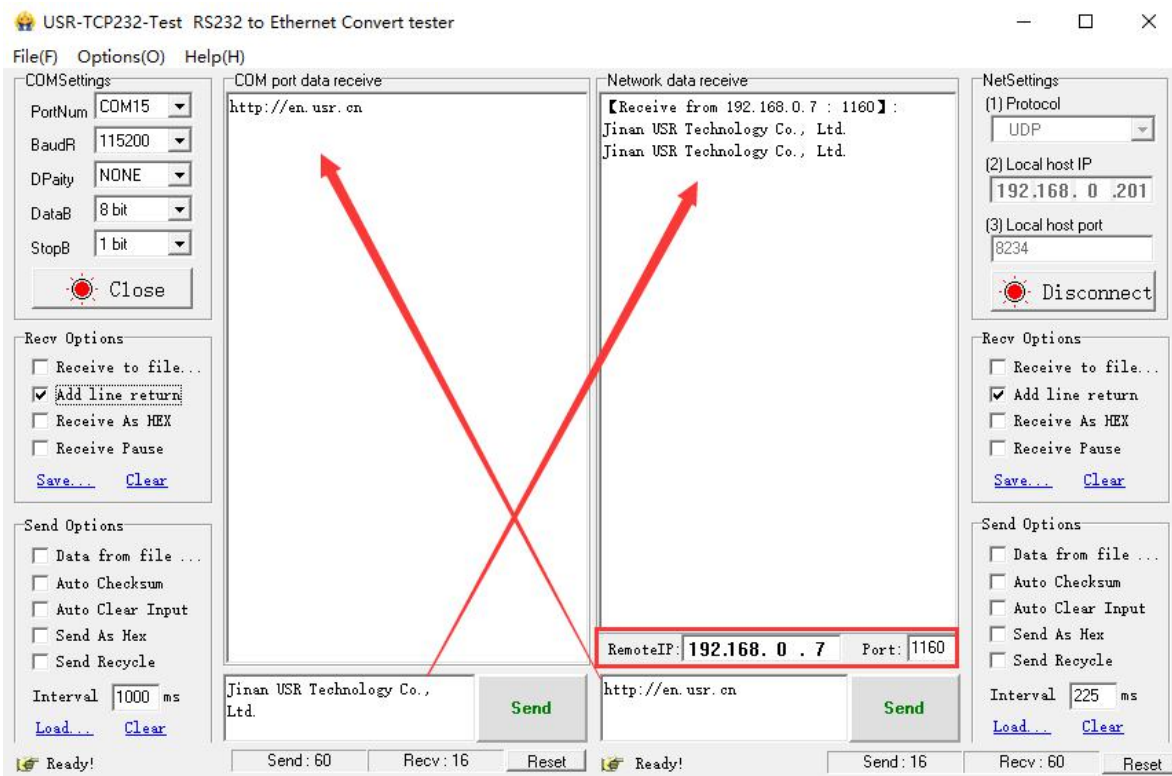

## 4.5 UDP Server Mode

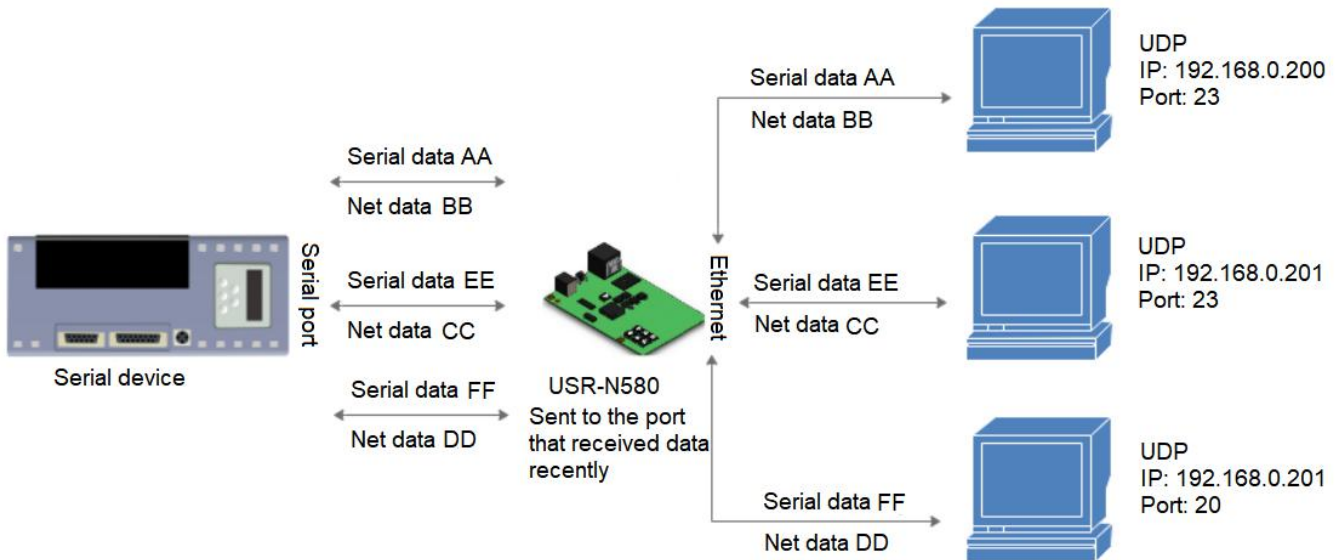

In UDP Server mode, the source IP address is not verified. After receiving a UDP packet, the destination IP is changed to the source IP and port number of the data. When sending data, it is sent to the last IP and port number that have communicated.

Test example:

- Set the N580 to **UDP server**, **Local port** to 20108. **Save** and **Restart** the device.
- Open two **USR-TCP232-Test** software, set to **UDP mode**, **Local host IP** is the PC's IP, set two different **Local host port**. Click **Connect**. In network side, **Remote IP** is the N580's IP address, **Port** is 20108.
- Data from two network ports all can be sent to the serial side, but when serial data will only be sent to the last IP and port that have communicated.

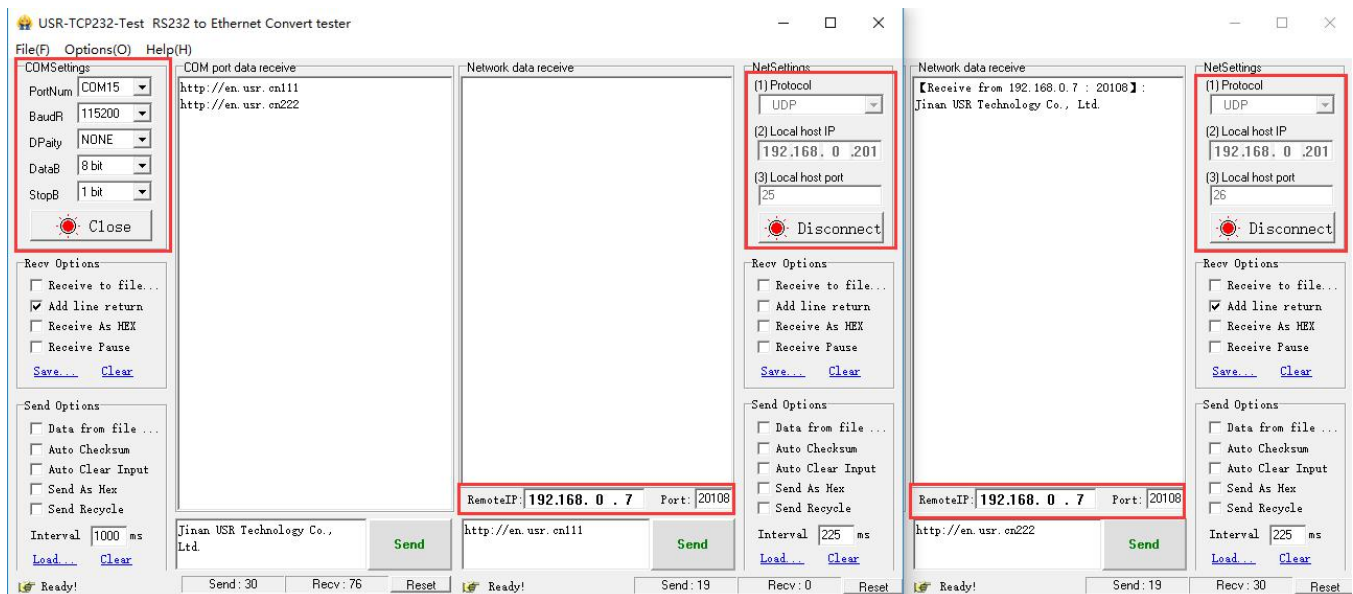

## 4.6 Httpd Client Mode

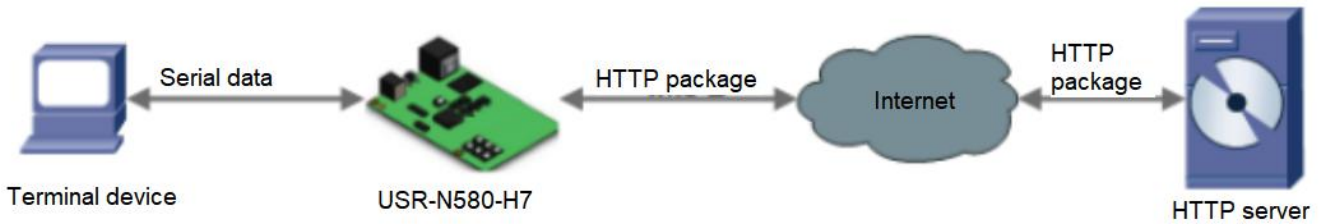

1. In this mode, the user's terminal device can send request data to the specified HTTP server through N580, and then N580 receives and parses the data from the HTTP server and sends to the serial device.
2. When N580 sends data to HTTP server via serial port, the required URL and header, destination domain name /IP, port and other information can be set by N580. All you need to do is send the request data, then N580 will automatically add URLs and headers. You can also choose whether to remove the header of the returned data.
3. Test example:
  - Connect the device to a router that can access the Internet.
  - Set the **Work mode** to **httpd client**, set the **Remote server address**, **port**, **URL**, **Header** and other information of the server. **Save** and **Restart** the device.

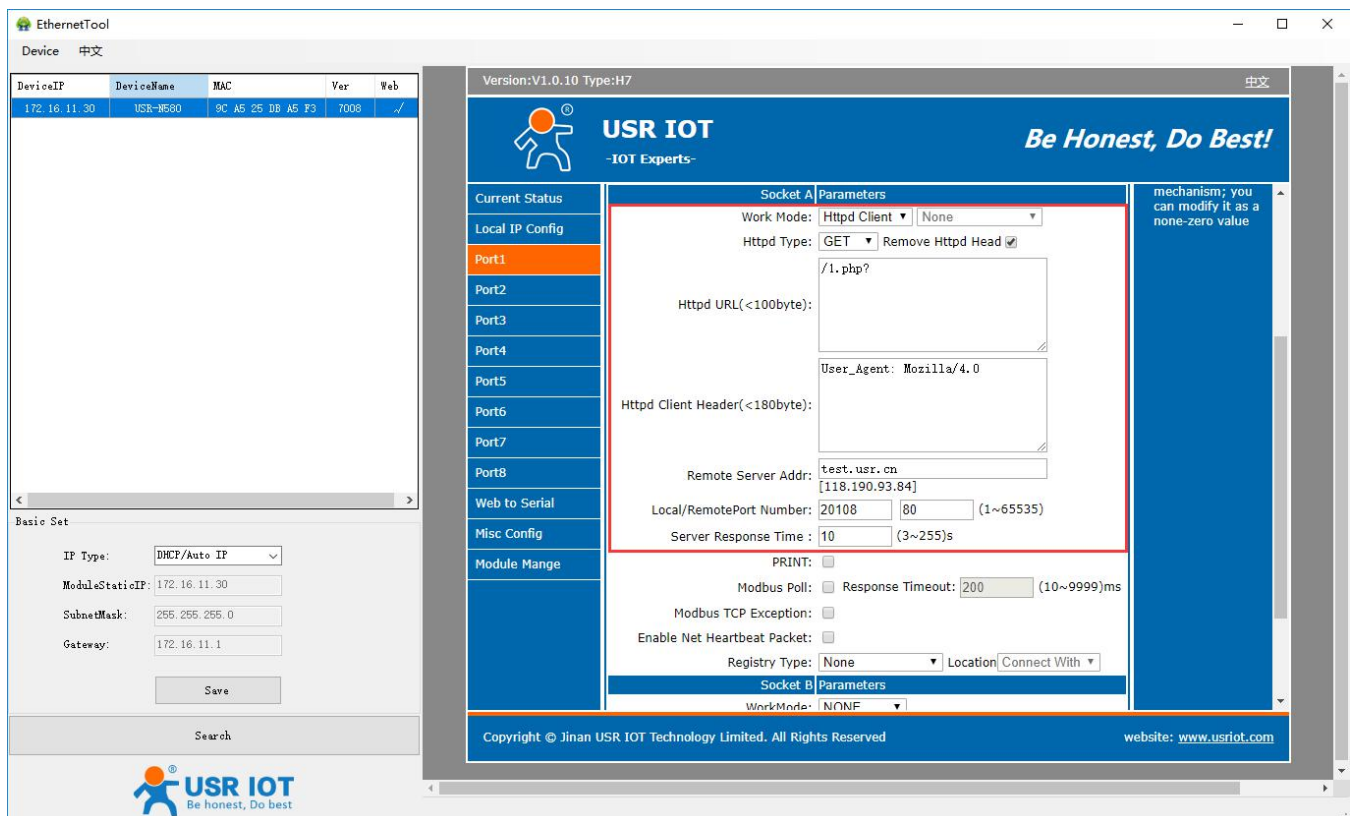

- When send "data=1234" from the serial port, will receive "1234" returned from the HTTP test server.

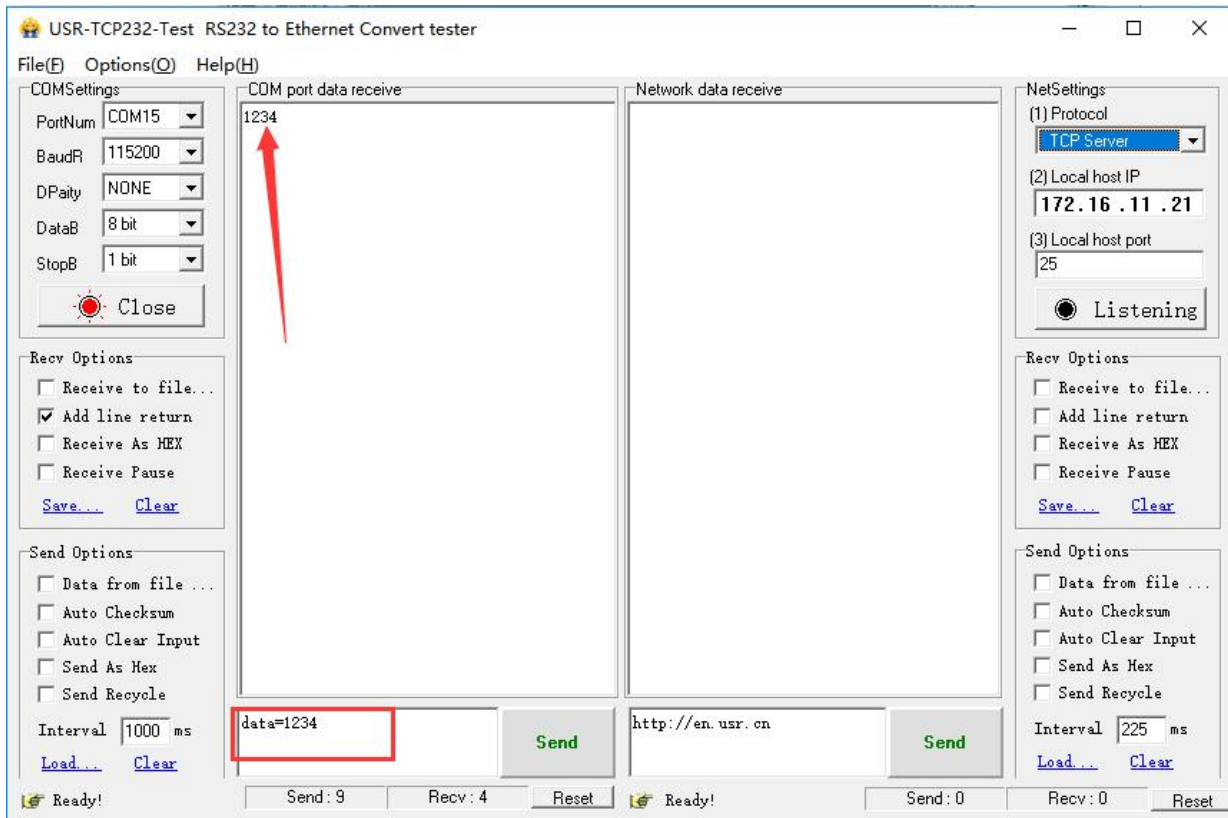

## 5. General Functions

### 5.1 Serial Packaging Mechanism

USR-N580 can configure serial port packaging time and serial port packaging length. USR-N580 will make packaging for the data of serial port according to the packaging length and packaging time in the transparent transmission mode.

Example for judgment of packaging time and packaging length:

1. Set packaging time as 10ms, packaging length as 512 bytes.  
When serial port received data, USR-N580 will package and send it to network if the interval time of receiving data is over than 10ms or data length is more than 512.
2. If the value of packaging time or packaging length is 0, the packaging rule is effective for non-zero one.
3. Set packaging time and length as 0.  
USR-N580 will conduct default packaging time when packaging time is set as 0ms. When serial port receiving data, USR-N580 will package and send the data to network if interval time more than packaging time of sending 4 bytes. For example, baud rate 115200, packaging time for 4 bytes is  $T=0.4\text{ms}$ , when the calculated value is smaller than 0.1ms, packaging time can be calculated as 0.1ms.

$$T = 1/\text{baud rate} * 10 * 4$$

When USR-N580 receives data from network and then send to serial port, as the limit of serial port speed, user have to control the flow, if not the problem of data overflow on serial port side will occur. So data flow is required to calculated when sending data from network to serial port.

Example:

Network sends data in m bytes every n seconds. Method of checking if there is overflow: ( Supposed network condition is good and network data transmission time is negligible)

If there is no overflow, m bytes data must be transmitted within n seconds, then the transmitting time of M bytes data:

$$T = \frac{1}{\text{Baud Rate}} * 10 * m$$

If  $n > 2T$ , then data will not overflow, USR-N580 can work normally. Just need keep  $n > T$  under baud rate 9600.

### 5.2 Flow Control

1. NONE: No flow control.
2. Xon/Xoff: Software flow control function. It is disabled by default. In this mode, the command character of serial port sends data is 0x11. 0x13 is not allowed.

## 5.3 RFC2217

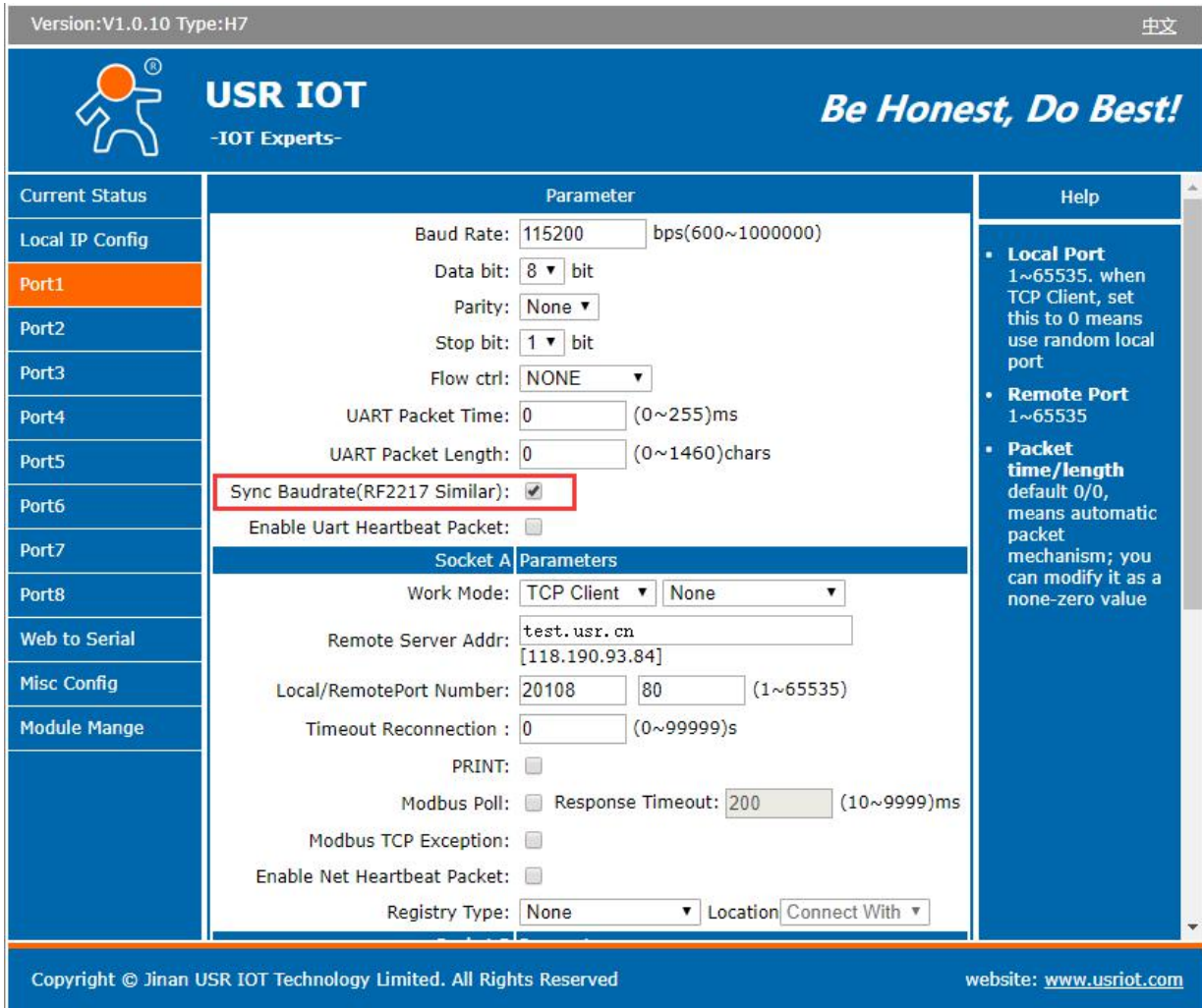

Version:V1.0.10 Type:H7 中文

**USR IOT**  
-IOT Experts- *Be Honest, Do Best!*

Current Status	Parameter	Help
Local IP Config	Baud Rate: <input type="text" value="115200"/> bps(600~1000000)	<ul style="list-style-type: none"> <li><b>Local Port</b> 1~65535. when TCP Client, set this to 0 means use random local port</li> <li><b>Remote Port</b> 1~65535</li> <li><b>Packet time/length</b> default 0/0, means automatic packet mechanism; you can modify it as a none-zero value</li> </ul>
Port1	Data bit: <input type="text" value="8"/> bit	
Port2	Parity: <input type="text" value="None"/>	
Port3	Stop bit: <input type="text" value="1"/> bit	
Port4	Flow ctrl: <input type="text" value="NONE"/>	
Port5	UART Packet Time: <input type="text" value="0"/> (0~255)ms	
Port6	UART Packet Length: <input type="text" value="0"/> (0~1460)chars	
Port7	<b>Sync Baudrate(RF2217 Similar):</b> <input checked="" type="checkbox"/>	
Port8	Enable Uart Heartbeat Packet: <input type="checkbox"/>	
Web to Serial	<b>Socket A Parameters</b> Work Mode: <input type="text" value="TCP Client"/> <input type="text" value="None"/>	
Misc Config	Remote Server Addr: <input type="text" value="test.usr.cn"/> [118.190.93.84]	
Module Mange	Local/RemotePort Number: <input type="text" value="20108"/> <input type="text" value="80"/> (1~65535)	
	Timeout Reconnection : <input type="text" value="0"/> (0~99999)s	
	PRINT: <input type="checkbox"/>	
	Modbus Poll: <input type="checkbox"/> Response Timeout: <input type="text" value="200"/> (10~9999)ms	
	Modbus TCP Exception: <input type="checkbox"/>	
	Enable Net Heartbeat Packet: <input type="checkbox"/>	
	Registry Type: <input type="text" value="None"/> Location <input type="text" value="Connect With"/>	

Copyright © Jinan USR IOT Technology Limited. All Rights Reserved website: [www.usriot.com](http://www.usriot.com)

During the operation of USR-N580-H7, the serial port parameters of N580 can be dynamically changed from the network side through the similar RFC2217 function. Default is enabled. **TCP Client**, **TCP Server**, **UDP Client**, **UDP Server**, and **Multicast** mode all support RFC2217.

This command is effective immediately and no need to restart.

1. This function is modified on the basis of RFC2217 protocol to improve the accuracy of transmission. Protocol length is 8 bytes, values take for example is in HEX:



Name	Packet Header	Baud Rate	Bytes parameter	Parity
Bytes	3	3	1	1
Explanation	reduce misjudgment	High is in front, smallest is 600(00 02 58)	data bit/stop bit/parity	Sum of 4 bits without the header, ignore the high bit
(115200, N,8,1)	55 AA 55	01 C2 00	03	C6
(9600, N,8,1)	55 AA 55	00 25 80	03	A8

Serial parameter bit:

Bit	Explanation	Value	Description
1:0	Data bit	00	5 bits
		01	6 bits
		10	7 bits
		11	8bits
2	Stop Bit	00	1 bit
		01	2bits
3	Parity Enable	00	Disable Parity
		01	Enable Parity
5:4	Parity Type	00	ODD
		01	EVEN
		10	Mark
		11	Clear
8:6	NC	00	0

2. Enable **Sync Baudrate(RF2217 Similar)** function when needed; send RFC2217 data package from the network side to N580 to change the corresponding serial parameters.
3. Test example:  
 Protocol command:  
 55AA5501C2008346 set the serial parameters to 115200,N, 8, 1  
 55AA550025808328 set the serial parameters to 9600, N, 8, 1

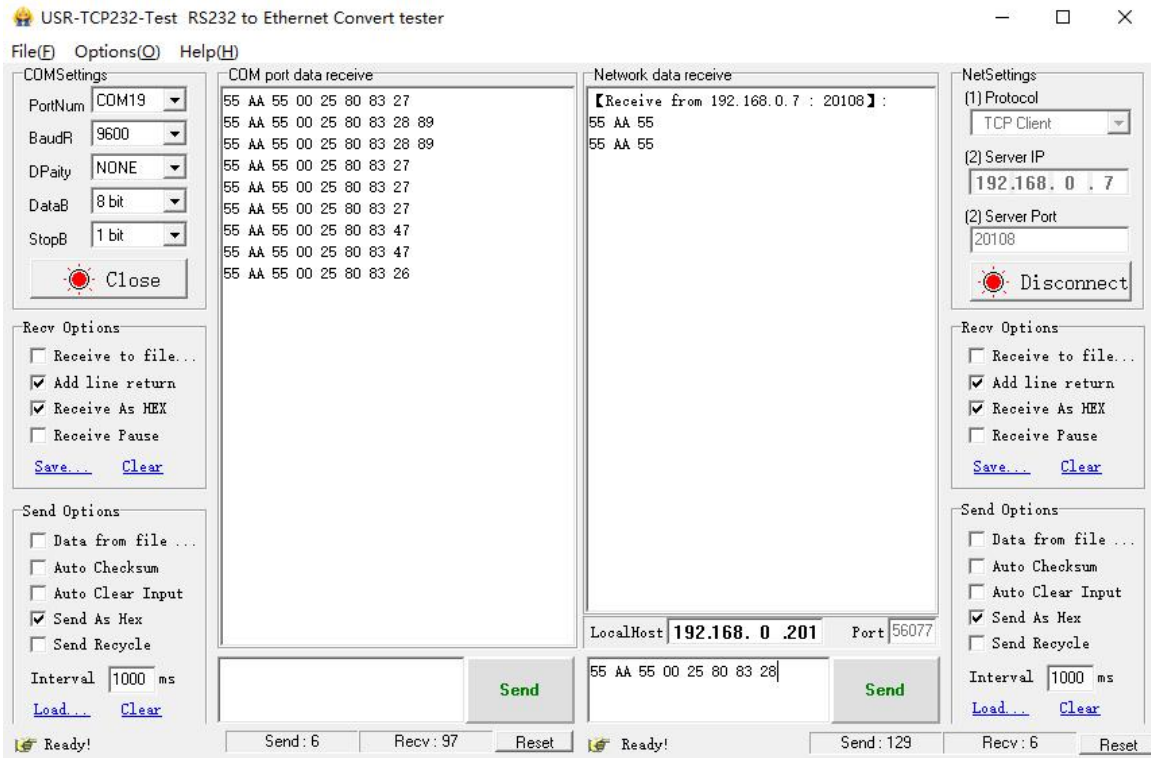

## 5.4 Modbus

### ➤ Modbus RTU to Modbus TCP protocol conversion

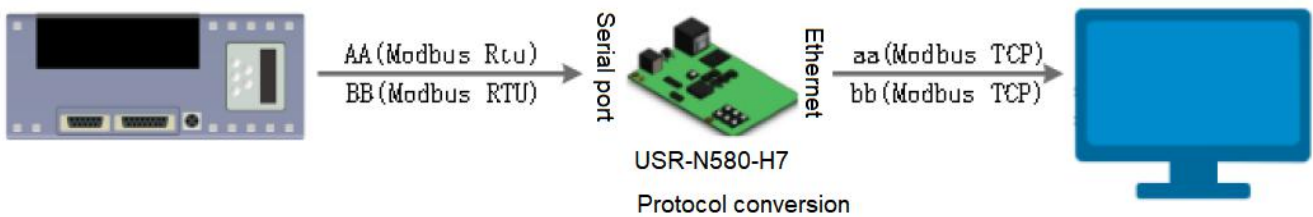

1. Open the webpage of N580, set it to **TCP client** or **TCP server**.
2. Select **Modbus TCP**.
3. Save the parameters.

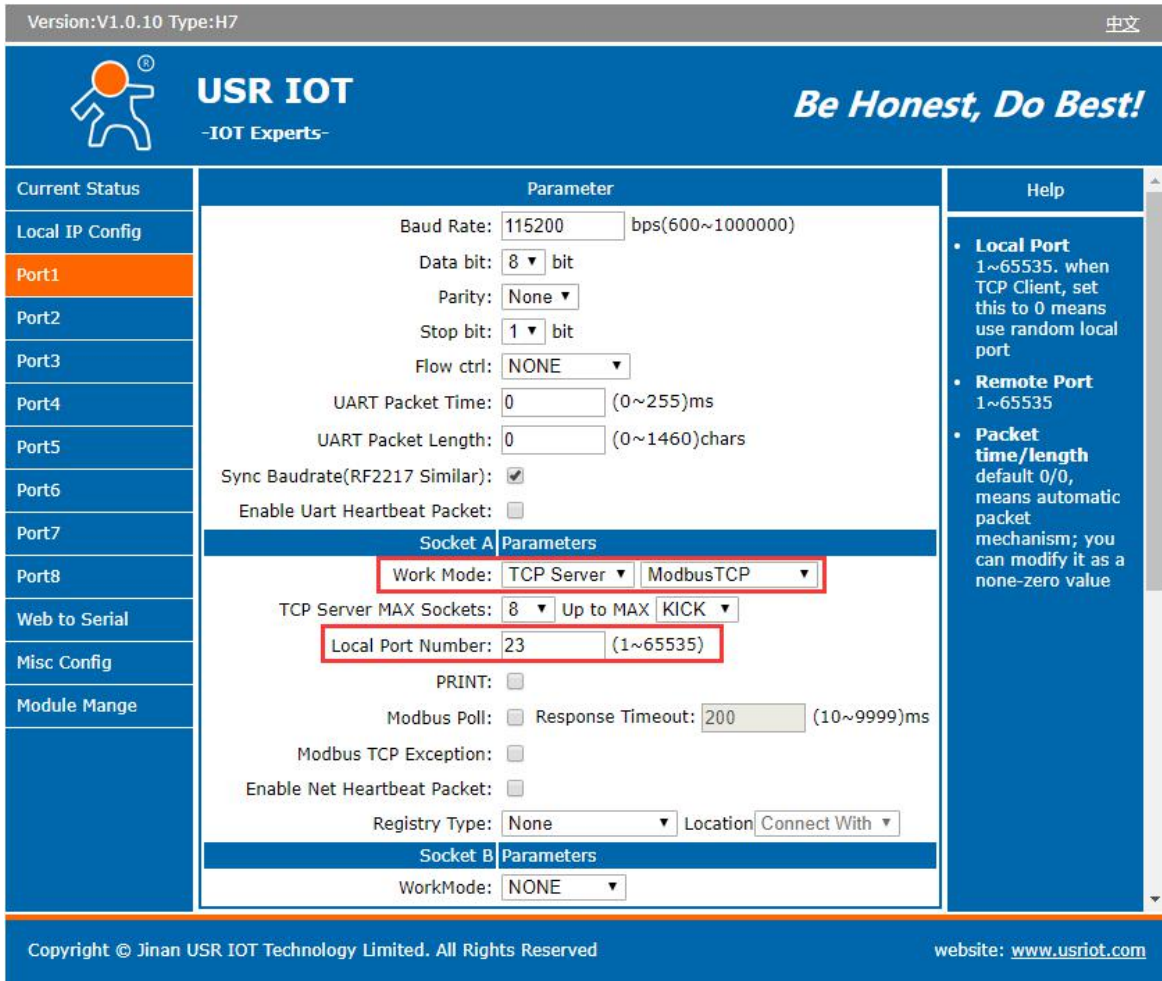

4. Query and verify Modbus TCP to Modbus RTU through Modbus Poll and Modbus Slave software.

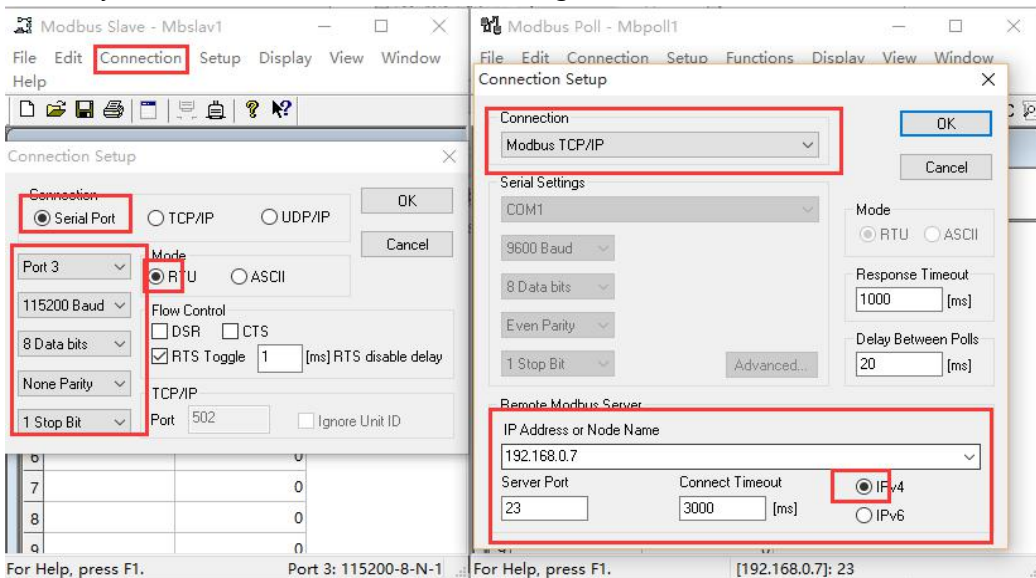

5. Click OK to update Modbus Slave data.

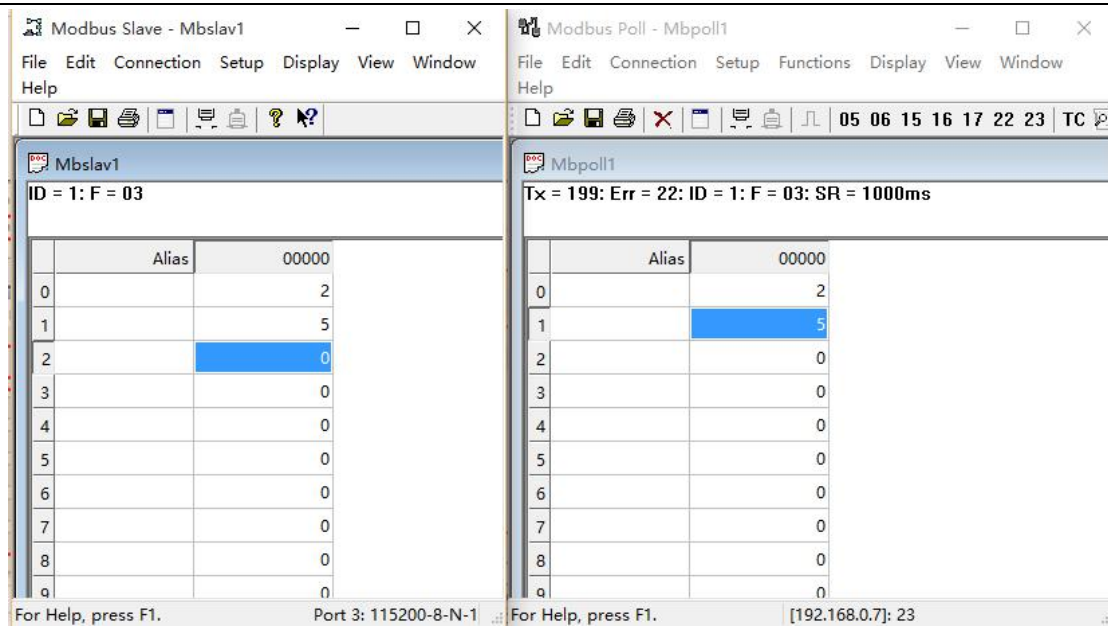

➤ Modbus active polling:

Through the serial port heartbeat packet function of N580, can realize Modbus active polling.

1. Enable **Uart Heartbeat Packet** in the webpage. **Heartbeat Packet** content is the query command.

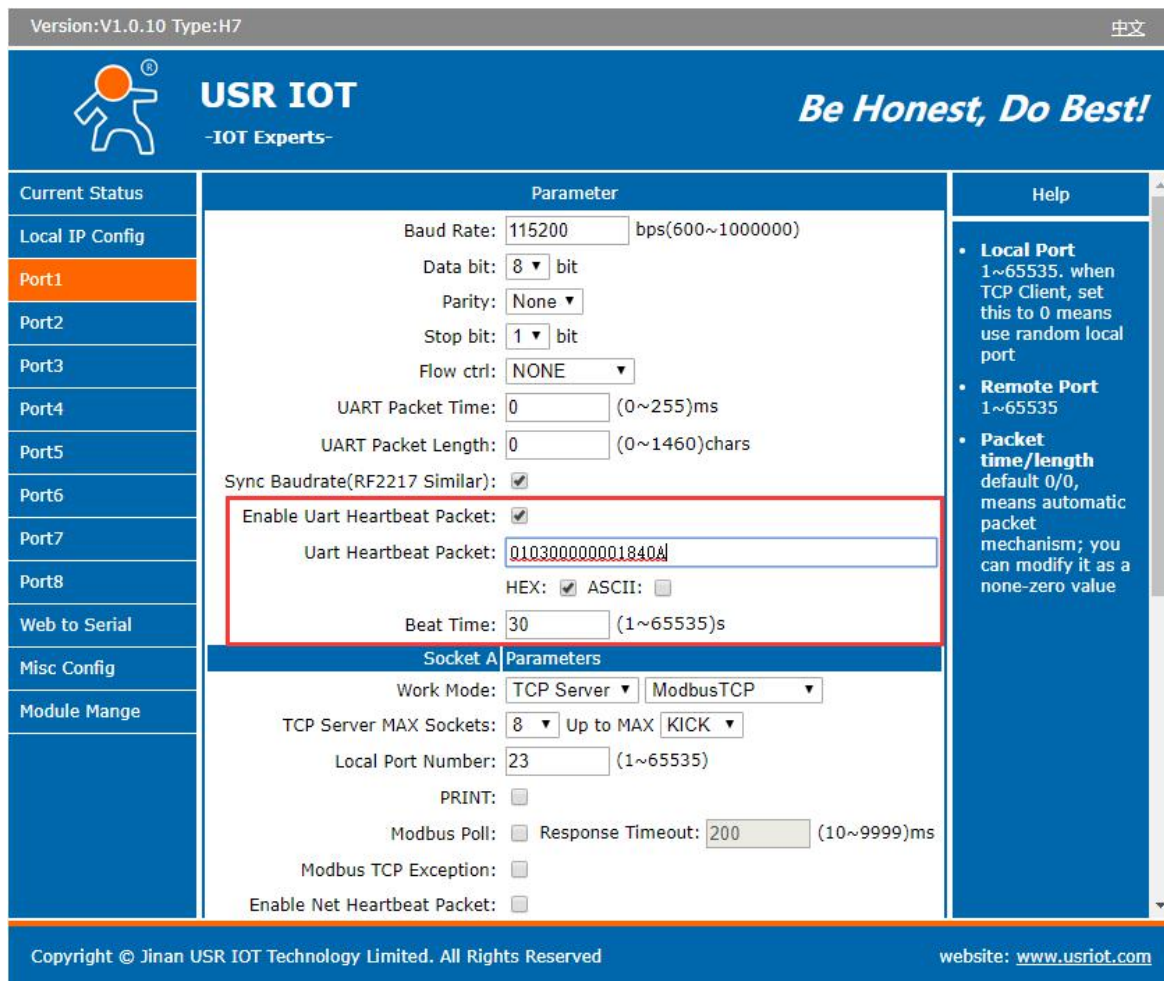

2. Set the Modbus slave software.
3. Check the returned Modbus TCP data.

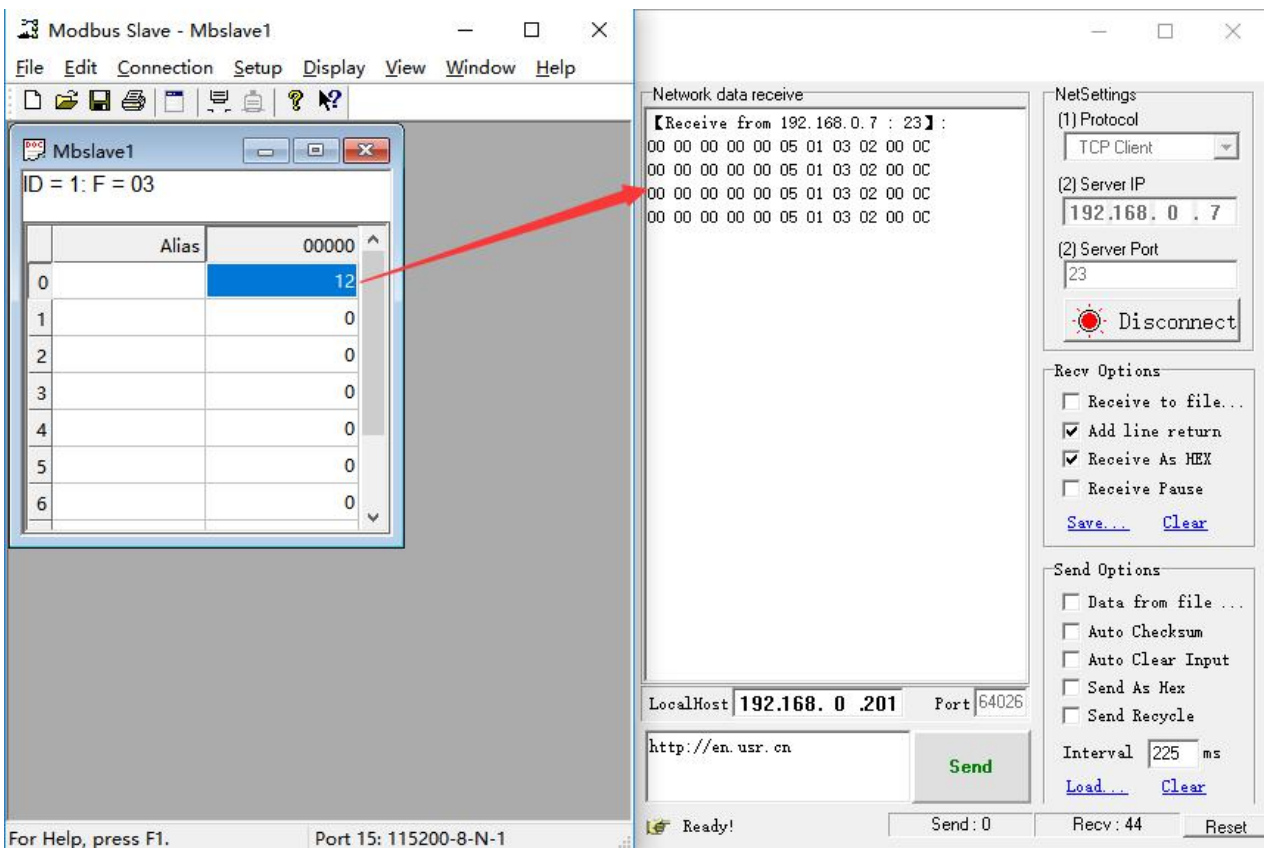
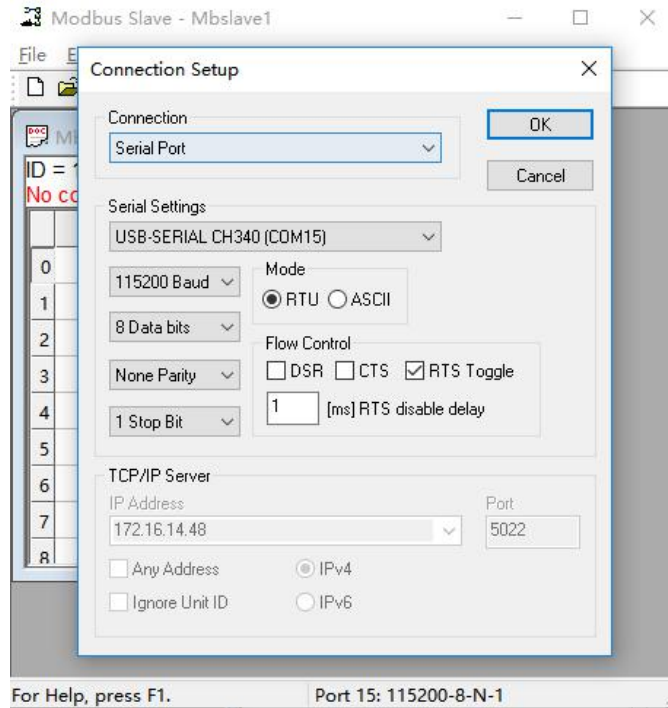

➤ Modbus Poll

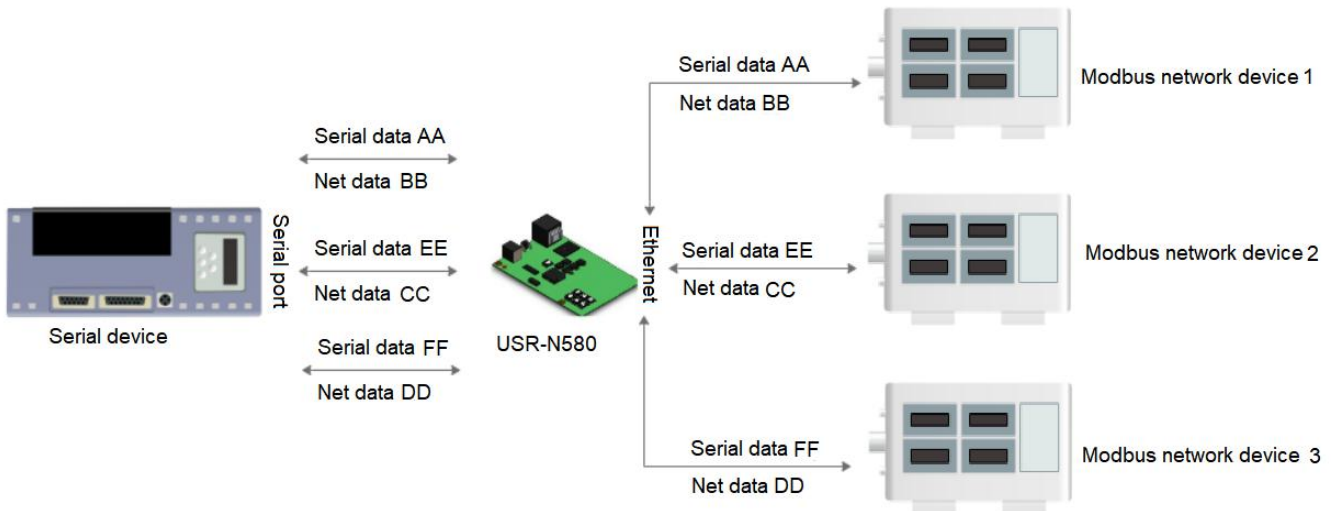

USR-N580 supports Modbus poll function. Set the device to Modbus poll mode, support query parameters via multiple masters.

1. Enable **Modbus poll** function, set the **Response Timeout**.

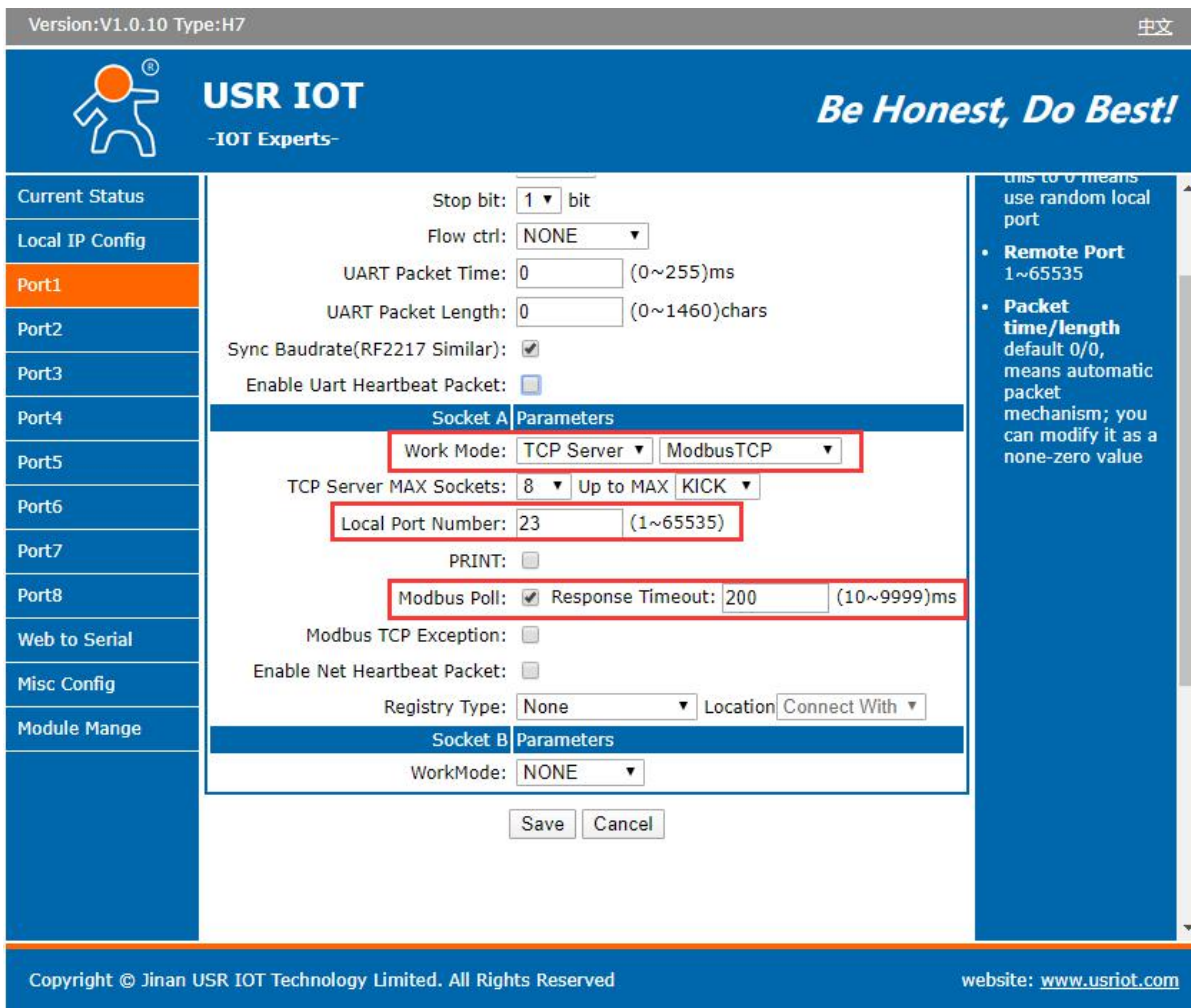

Version: V1.0.10 Type: H7 中文

**USR IOT**  
-IOT Experts- *Be Honest, Do Best!*

Current Status  
Local IP Config  
**Port1**  
Port2  
Port3  
Port4  
Port5  
Port6  
Port7  
Port8  
Web to Serial  
Misc Config  
Module Mange

Stop bit: 1 bit  
Flow ctrl: NONE  
UART Packet Time: 0 (0~255)ms  
UART Packet Length: 0 (0~1460)chars  
Sync Baudrate(RF2217 Similar):   
Enable Uart Heartbeat Packet:

**Socket A Parameters**

Work Mode: TCP Server ModbusTCP  
TCP Server MAX Sockets: 8 Up to MAX KICK  
Local Port Number: 23 (1~65535)  
PRINT:   
Modbus Poll:  Response Timeout: 200 (10~9999)ms  
Modbus TCP Exception:   
Enable Net Heartbeat Packet:   
Registry Type: None Location: Connect With

**Socket B Parameters**

WorkMode: NONE

Save Cancel

this to 0 means use random local port

- Remote Port 1~65535
- Packet time/length default 0/0, means automatic packet mechanism; you can modify it as a none-zero value

Copyright © Jinan USR IOT Technology Limited. All Rights Reserved website: [www.usriot.com](http://www.usriot.com)

- Open multiple **Modbus Poll** software to connect to N580 as TCP clients, all can get data from the serial Modbus slave side.

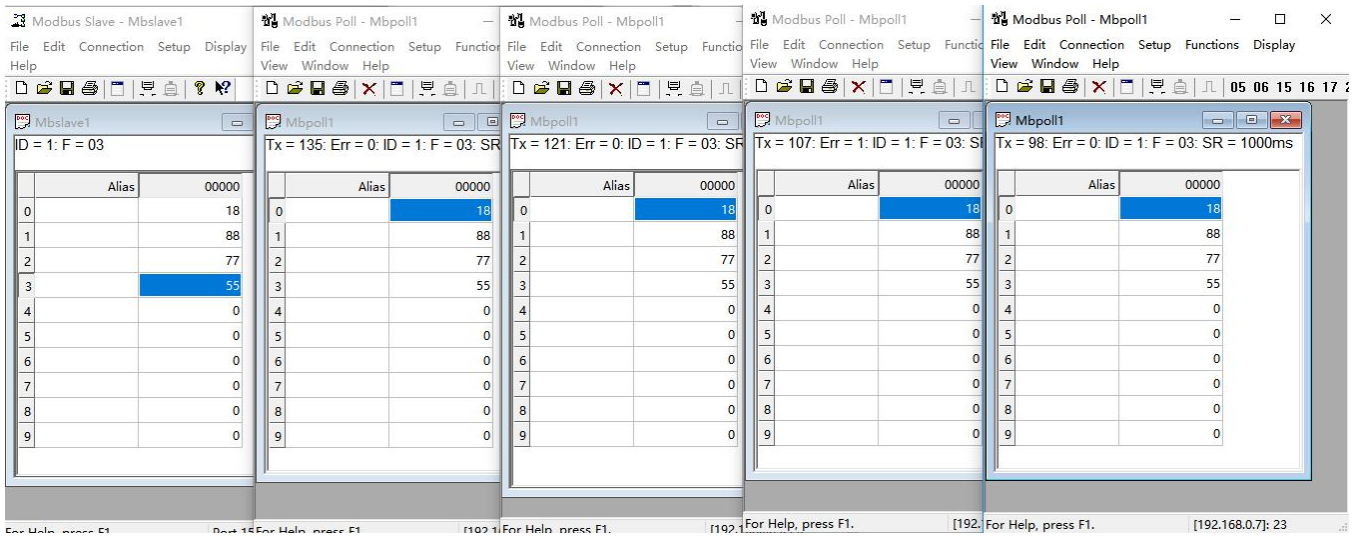

## 5.5 Heartbeat Packet

Heartbeat packet includes network heartbeat and serial port heartbeat. N580 device can send heartbeat packet to the serial port or network side.

Serial heartbeat packet can be sent to the serial port as a fixed query command.

Network heartbeat packet is used for maintaining connection. Only valid in TCP Client and UDP Client mode.

Test example:

- Enable **Serial heartbeat packet (UART heartbeat packet)**

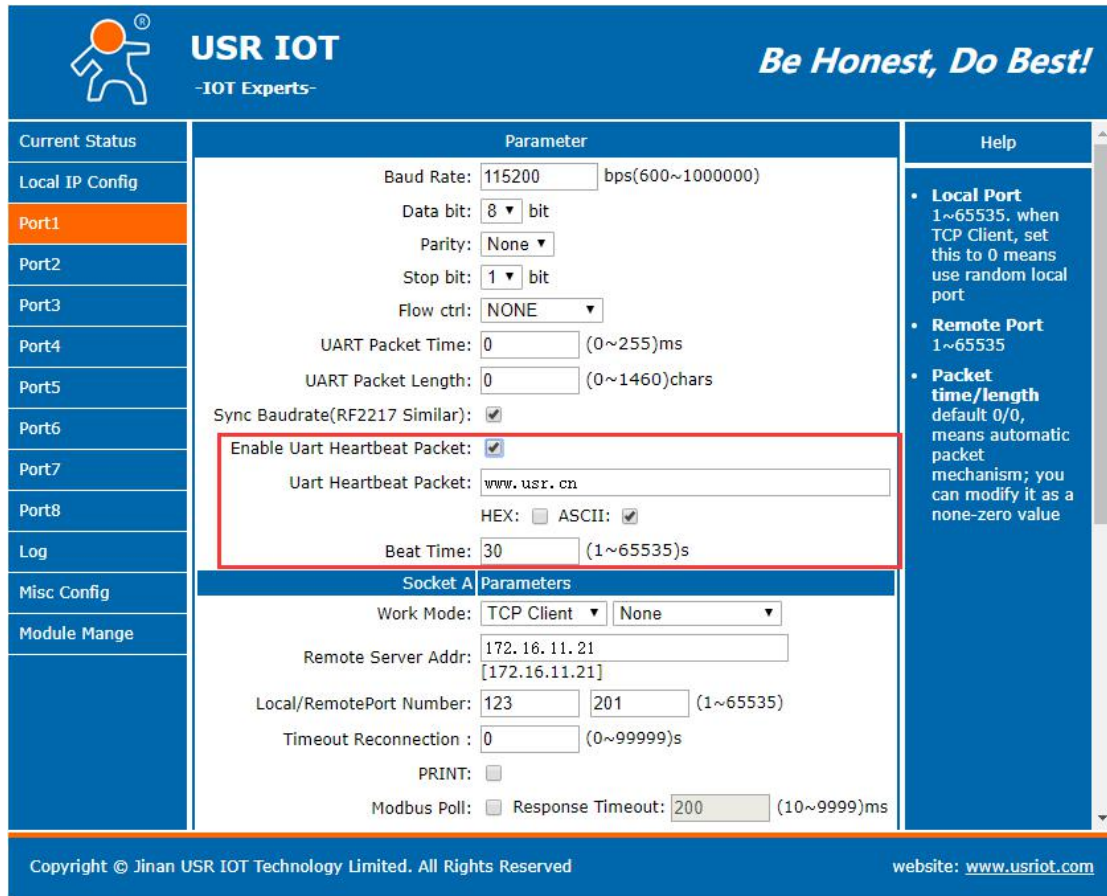

**USR IOT**  
-IOT Experts-

*Be Honest, Do Best!*

Current Status	Parameter	Help
Local IP Config	Baud Rate: 115200 bps(600~1000000)	<ul style="list-style-type: none"> <li><b>Local Port</b> 1~65535, when TCP Client, set this to 0 means use random local port</li> <li><b>Remote Port</b> 1~65535</li> <li><b>Packet time/length</b> default 0/0, means automatic packet mechanism; you can modify it as a none-zero value</li> </ul>
<b>Port1</b>	Data bit: 8 bit	
Port2	Parity: None	
Port3	Stop bit: 1 bit	
Port4	Flow ctrl: NONE	
Port5	UART Packet Time: 0 (0~255)ms	
Port6	UART Packet Length: 0 (0~1460)chars	
Port7	Sync Baudrate(RF2217 Similar): <input checked="" type="checkbox"/>	
Port8	<b>Enable Uart Heartbeat Packet:</b> <input checked="" type="checkbox"/>	
Log	Uart Heartbeat Packet: www.usr.cn	
Misc Config	HEX: <input type="checkbox"/> ASCII: <input checked="" type="checkbox"/>	
Module Mange	Beat Time: 30 (1~65535)s	
	<b>Socket A Parameters</b>	
	Work Mode: TCP Client   None	
	Remote Server Addr: 172.16.11.21 [172.16.11.21]	
	Local/RemotePort Number: 123   201 (1~65535)	
	Timeout Reconnection: 0 (0~99999)s	
	PRINT: <input type="checkbox"/>	
	Modbus Poll: <input type="checkbox"/> Response Timeout: 200 (10~9999)ms	

Copyright © Jinan USR IOT Technology Limited. All Rights Reserved website: [www.usriot.com](http://www.usriot.com)

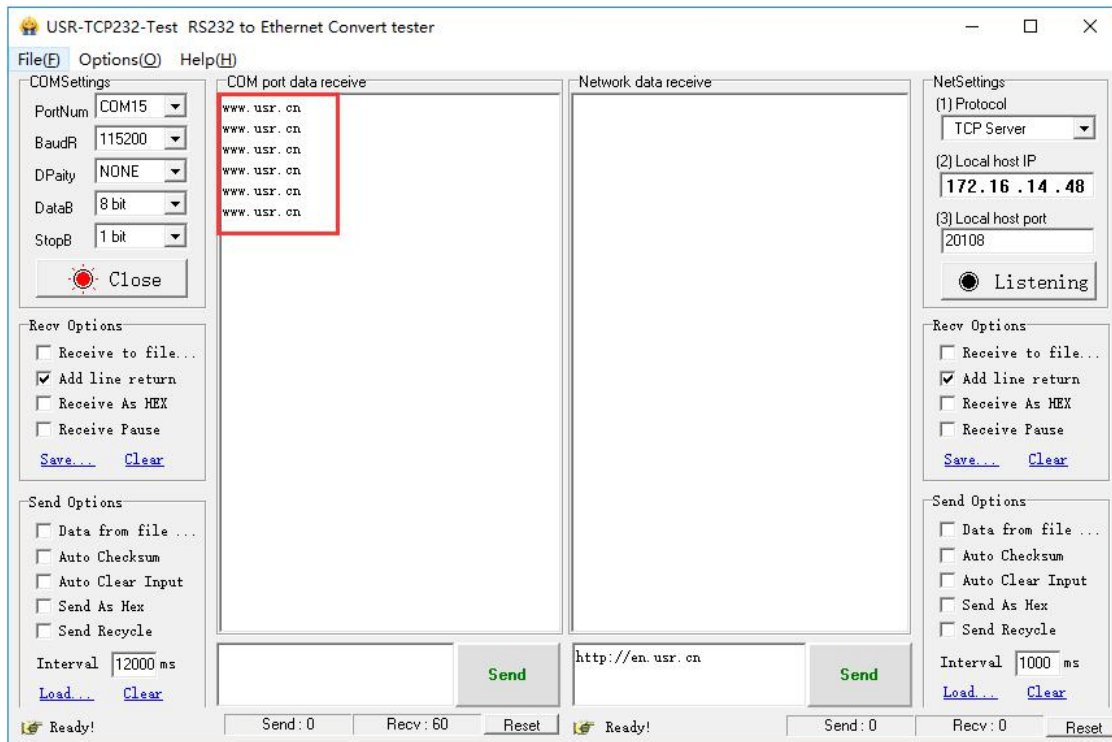

USR-TCP232-Test RS232 to Ethernet Convert tester

File(E) Options(O) Help(H)

COMSettings: PortNum: COM15, BaudR: 115200, DParity: NONE, DataB: 8 bit, StopB: 1 bit

Recv Options:  Receive to file...,  Add line return,  Receive As HEX,  Receive Pause

Send Options:  Data from file...,  Auto Checksum,  Auto Clear Input,  Send As Hex,  Send Recycle, Interval: 12000 ms

COM port data receive: www.usr.cn

Network data receive: http://en.usr.cn

NetSettings: (1) Protocol: TCP Server, (2) Local host IP: 172.16.14.48, (3) Local host port: 20108, Listening

Recv Options:  Receive to file...,  Add line return,  Receive As HEX,  Receive Pause

Send Options:  Data from file...,  Auto Checksum,  Auto Clear Input,  Send As Hex,  Send Recycle, Interval: 1000 ms

Ready! Send: 0 Recv: 60 Reset Ready! Send: 0 Recv: 0 Reset



## 2. Enable Net heartbeat packet

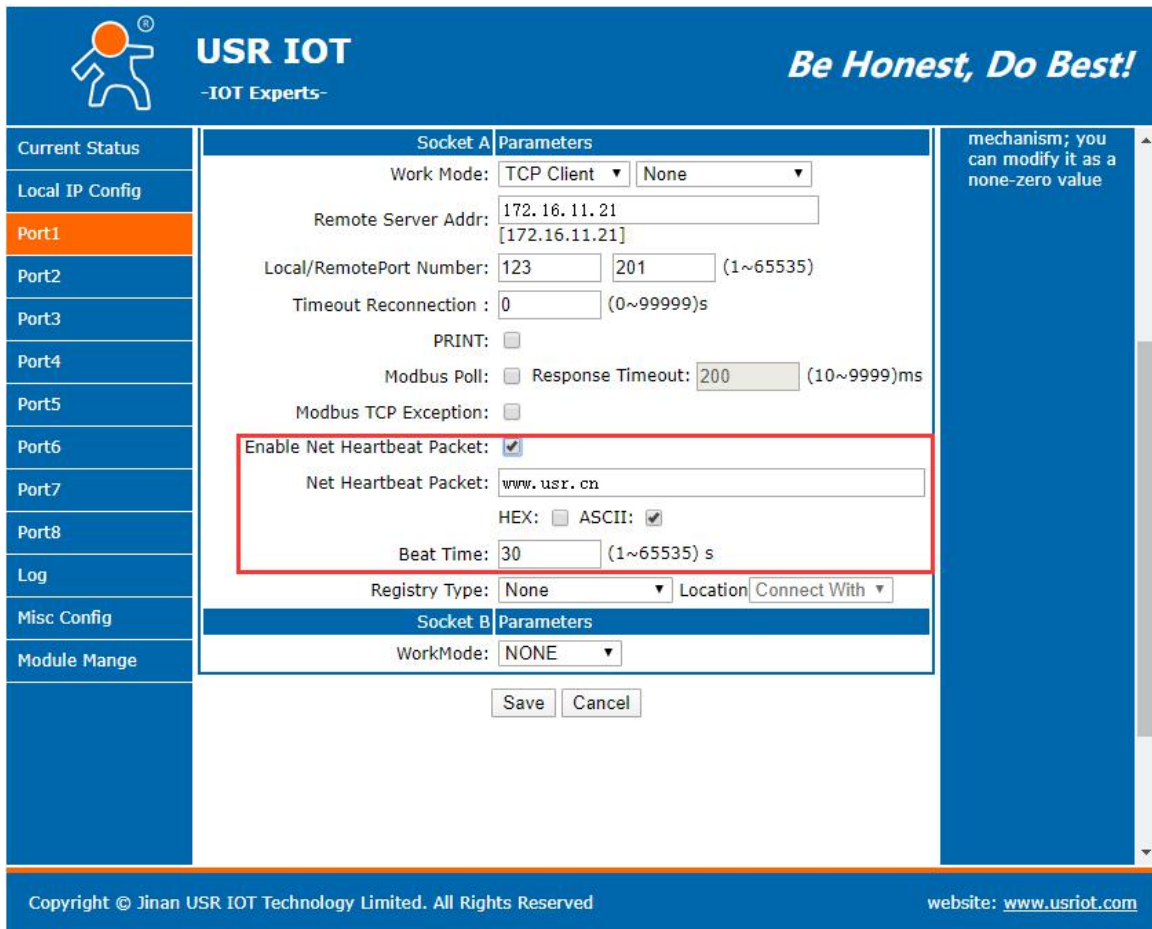

**USR IOT**  
-IOT Experts-  
*Be Honest, Do Best!*

**Current Status**  
**Local IP Config**  
**Port1**  
Port2  
Port3  
Port4  
Port5  
Port6  
Port7  
Port8  
Log  
Misc Config  
Module Mange

**Socket A Parameters**  
Work Mode: TCP Client | None  
Remote Server Addr: 172.16.11.21  
[172.16.11.21]  
Local/RemotePort Number: 123 | 201 (1~65535)  
Timeout Reconnection: 0 (0~99999)s  
PRINT:   
Modbus Poll:  Response Timeout: 200 (10~9999)ms  
Modbus TCP Exception:   
**Enable Net Heartbeat Packet:**   
Net Heartbeat Packet: www.usr.cn  
HEX:  ASCII:   
Beat Time: 30 (1~65535) s  
Registry Type: None | Location | Connect With |  
**Socket B Parameters**  
WorkMode: NONE

mechanism; you can modify it as a none-zero value

Save Cancel

Copyright © Jinan USR IOT Technology Limited. All Rights Reserved  
website: [www.usriot.com](http://www.usriot.com)

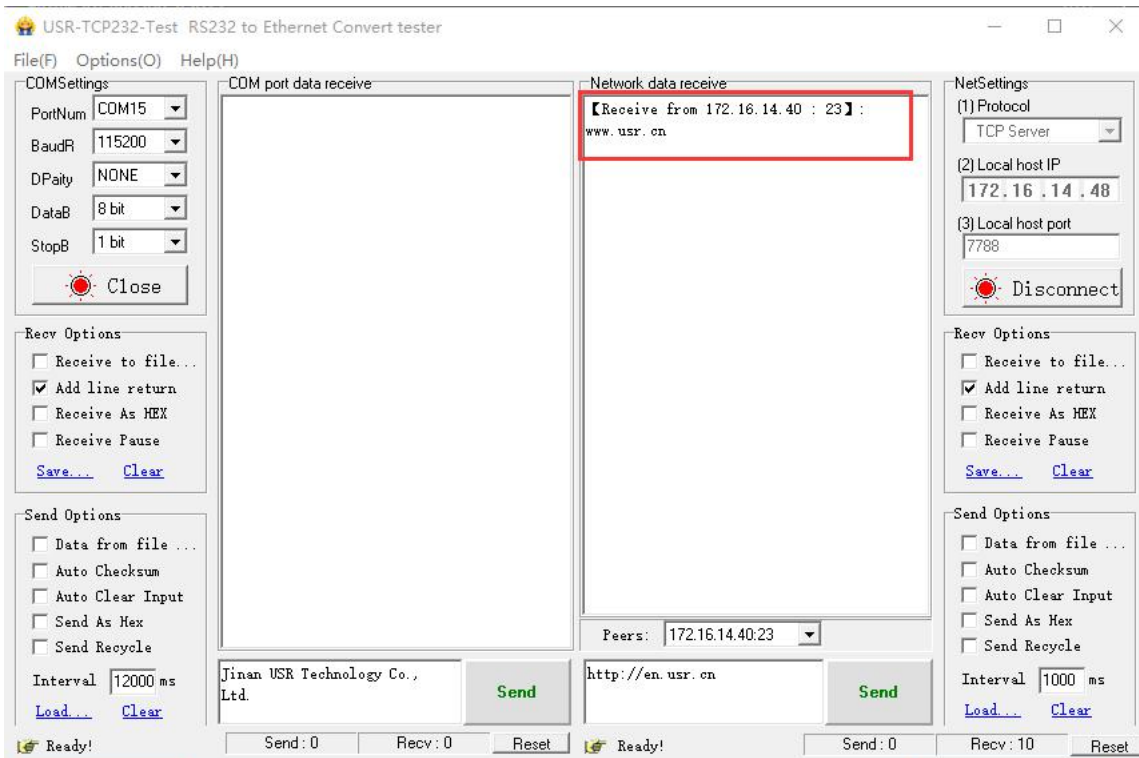

USR-TCP232-Test RS232 to Ethernet Convert tester

File(F) Options(O) Help(H)

**COMSettings**  
PortNum: COM15  
BaudR: 115200  
DPaity: NONE  
DataB: 8 bit  
StopB: 1 bit  
Close

**Recv Options**  
 Receive to file...  
 Add line return  
 Receive As HEX  
 Receive Pause  
Save... Clear

**Send Options**  
 Data from file...  
 Auto Checksum  
 Auto Clear Input  
 Send As Hex  
 Send Recycle  
Interval: 12000 ms  
Load... Clear

**COM port data receive**

**Network data receive**  
【Receive from 172.16.14.40 : 23】 :  
www.usr.cn

**NetSettings**  
(1) Protocol: TCP Server  
(2) Local host IP: 172.16.14.48  
(3) Local host port: 7788  
Disconnect

**Recv Options**  
 Receive to file...  
 Add line return  
 Receive As HEX  
 Receive Pause  
Save... Clear

**Send Options**  
 Data from file...  
 Auto Checksum  
 Auto Clear Input  
 Send As Hex  
 Send Recycle  
Interval: 1000 ms  
Load... Clear

Jinan USR Technology Co., Ltd. Send  
Peers: 172.16.14.40:23 http://en.usr.cn Send

Ready! Send: 0 Recv: 0 Reset Ready! Send: 0 Recv: 10 Reset

## 5.6 Registry Packet

There are three types of registry packets: USR Cloud, MAC, USER register(User-defined). MAC and USER register packet can be sent when establishing a TCP connection or carried before data or both. We will introduce USR Cloud in the next chapter.

USER Register packet is user-defined, maximum 40 bytes, supports hex data.

MAC defaults to HEX.

Connect with: sending register packet immediately when establish a connection. The main purpose is to allow the server to identify the data source device or to obtain a password for the server function authorization.

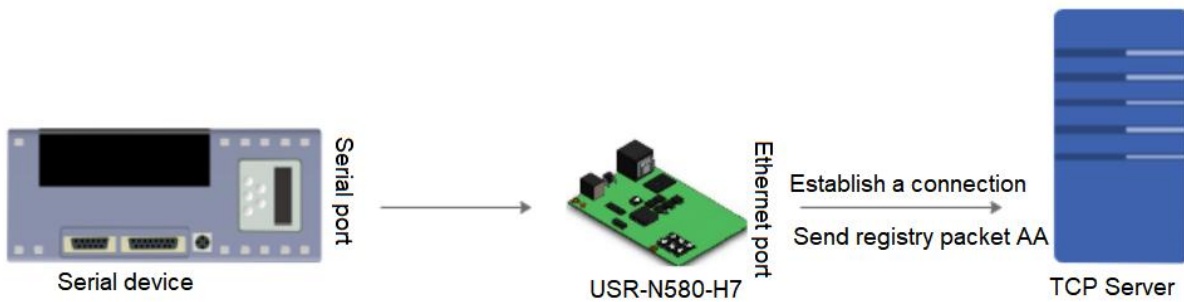

Data with: The packet header is carried uniformly when sending data.

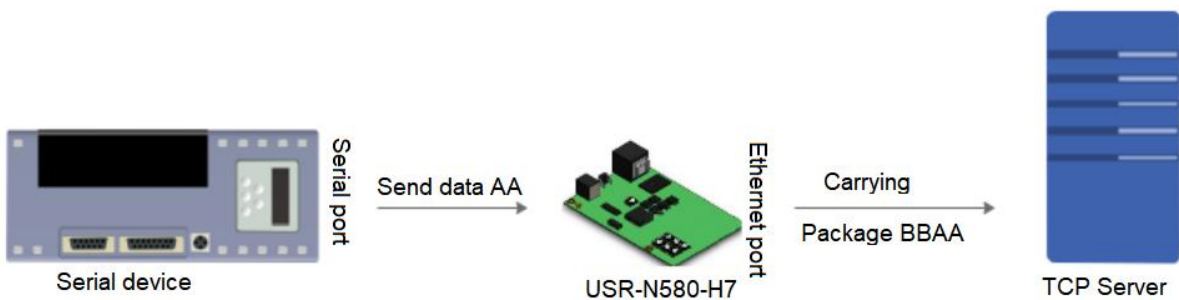

Registry packet can be configured via webpage:

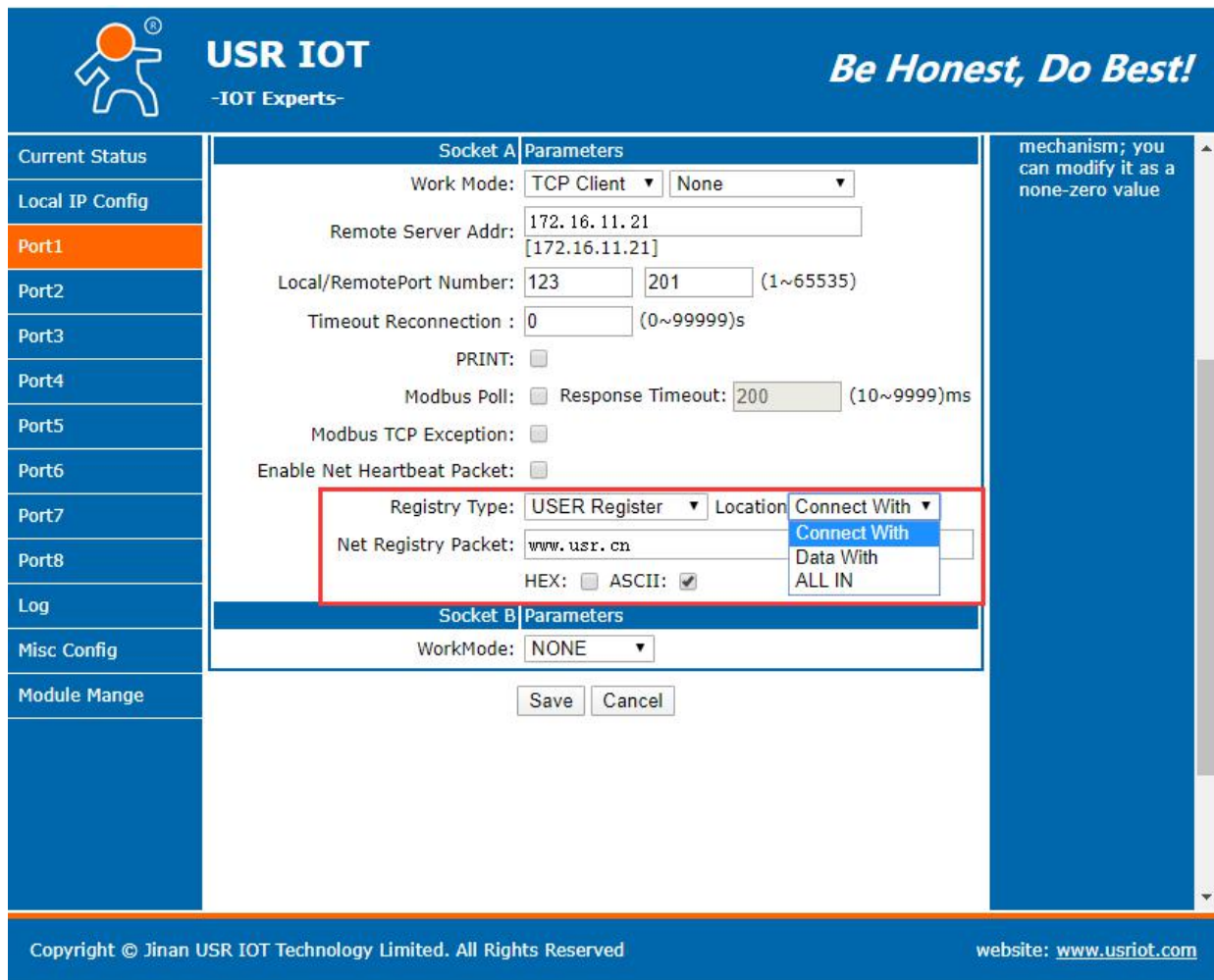

The screenshot shows the configuration page for Socket A. The 'Registry Type' is set to 'USER Register'. The 'Connect With' dropdown menu is open, showing three options: 'Connect With', 'Data With', and 'ALL IN'. The 'Net Registry Packet' is set to 'www.usr.cn'. The 'ASCII' checkbox is checked, and the 'HEX' checkbox is unchecked. The 'Work Mode' is set to 'TCP Client' and the 'Location' is set to 'None'. The 'Remote Server Addr' is '172.16.11.21'. The 'Local/RemotePort Number' is '123' and '201'. The 'Timeout Reconnection' is '0'. The 'Modbus Poll' is set to 'Response Timeout: 200'. The 'Modbus TCP Exception' is unchecked. The 'Enable Net Heartbeat Packet' is unchecked. The 'Socket B' parameters are set to 'WorkMode: NONE'. There are 'Save' and 'Cancel' buttons at the bottom.

## 5.7 Short Connection

TCP short connections are used primarily to save server resources and are generally used in multi-point to point scenarios. Using short connections ensures that existing connections are useful connections and that no additional control is required to filter them.

TCP short connection function is applied in TCP Client mode. After the short connection function is enabled, if the serial port or network port does not receive data within the set time, the connection will be automatically disconnected.

The short connection function is disabled by default. The disconnect time can be set between 2~255s, default to 3s.

Version:V1.0.10 Type:H7
中文



**USR IOT**  
 -IOT Experts-

*Be Honest, Do Best!*

Current Status Local IP Config <b>Port1</b> Port2 Port3 Port4 Port5 Port6 Port7 Port8 Web to Serial Misc Config Module Mange	<div style="border: 1px solid #0056b3; padding: 5px;"> <div style="background-color: #0056b3; color: white; padding: 2px; text-align: center; font-weight: bold;">Socket A Parameters</div> <div style="border: 2px solid red; padding: 5px; margin-bottom: 10px;">           Work Mode: <span style="border: 1px solid gray; padding: 2px;">TCP Client</span>   <span style="border: 1px solid gray; padding: 2px;">Short Connection</span>            Remote Server Addr: <span style="border: 1px solid gray; padding: 2px;">192.168.0.201</span> [N/A]            Local/RemotePort Number: <span style="border: 1px solid gray; padding: 2px;">20108</span>   <span style="border: 1px solid gray; padding: 2px;">80</span> (1~65535)            Timeout Reconnection : <span style="border: 1px solid gray; padding: 2px;">0</span> (0~99999)s            Disconnect Time : <span style="border: 1px solid gray; padding: 2px;">3</span> (3~255)s         </div>           PRINT: <input type="checkbox"/>            Modbus Poll: <input checked="" type="checkbox"/> Response Timeout: <span style="border: 1px solid gray; padding: 2px;">200</span> (10~9999)ms            Modbus TCP Exception: <input type="checkbox"/>            Enable Net Heartbeat Packet: <input type="checkbox"/>            Registry Type: <span style="border: 1px solid gray; padding: 2px;">USER Register</span>   Location <span style="border: 1px solid gray; padding: 2px;">Connect With</span>            Net Registry Packet: <span style="border: 1px solid gray; padding: 2px;">www.usr.cn</span>            HEX: <input type="checkbox"/> ASCII: <input checked="" type="checkbox"/> </div> <div style="border: 1px solid #0056b3; padding: 5px; margin-top: 10px;"> <div style="background-color: #0056b3; color: white; padding: 2px; text-align: center; font-weight: bold;">Socket B Parameters</div>           WorkMode: <span style="border: 1px solid gray; padding: 2px;">NONE</span> </div> <div style="text-align: center; margin-top: 10px;"> <input type="button" value="Save"/> <input type="button" value="Cancel"/> </div>	mechanism; you can modify it as a none-zero value
--	--	---

Copyright © Jinan USR IOT Technology Limited. All Rights Reserved
website: [www.usriot.com](http://www.usriot.com)

## 5.8 Uart Cache

When the TCP connection is not established, the data received by the serial port will be placed in the cache. The serial cache is dynamic and cached according to the size of the packet. When the packet length is 10Byte, 200 packets (2KB) can be cached, and when the length is 1460Byte, 5 packets (7.3KB) can be cached. After the TCP connection is established, the cache data can be set whether to clean up or not according to the customer's requirements.

This function defaults to be disabled. And it will be invalid when enable short connection in TCP Client or HTTPD Client mode.

USR IOT
-IOT Experts-
Be Honest, Do Best!

Current Status	parameter	help
Local IP Config	Module Name: <input type="text" value="USR-N580"/>	<ul style="list-style-type: none"> <li><b>Module Name</b> max length is 32 char</li> <li><b>Websocket Port</b> default 6432</li> <li><b>Websocket Direction</b> default UART1</li> <li><b>Web port</b> default 80</li> <li><b>User Name</b> default admin</li> <li><b>Pass Word</b> default admin</li> <li><b>Uart Cache</b> Whether caching serial data when abnormal connection,default don't cache</li> <li><b>Reset Timeout</b> default 0, 0-60 mean no timeout, &gt;60 mean when there is no data received during this time, the device will restart</li> </ul>
Port1	Websocket Port : <input type="text" value="6432"/>	
Port2	Websocket Direction : <input type="text" value="UART1"/>	
Port3	Webserver Port: <input type="text" value="80"/>	
Port4	User Name: <input type="text" value="admin"/>	
Port5	Pass Word: <input type="text" value="admin"/>	
Port6	Uart Cache: <input checked="" type="checkbox"/>	
Port7	Reset Timeout: <input type="text" value="0"/> (60~65535)	
Port8	<input type="button" value="Save"/> <input type="button" value="Cancel"/>	
Web to Serial		
Misc Config		
Module Mange		

Copyright © Jinan USR IOT Technology Limited. All Rights Reserved
website: [www.usriot.com](http://www.usriot.com)

## 5.9 UDP Multicast

Multicast can realize the one-to-many connection between data sender and receiver. Multiple receivers join the same multicast group and share the same IP address. At the same time, the members in the multicast group are dynamic, and the joining and quitting of a member do not affect the original multicast group. The valid address range for a multicast group is 224.0.0.2-239.255.255.255.

1. Webpage parameter settings

USR IOT
-IOT Experts-
Be Honest, Do Best!

Current Status	<table border="1" style="width: 100%; border-collapse: collapse;"> <thead> <tr> <th style="width: 30%; background-color: #0070C0; color: white;">Socket A</th> <th style="background-color: #0070C0; color: white;">Parameters</th> </tr> </thead> <tbody> <tr> <td style="padding: 2px;">Work Mode:</td> <td style="padding: 2px;"> <input type="text" value="UDP Client"/> <input type="text" value="Multicast"/> </td> </tr> <tr> <td style="padding: 2px;">Remote Server Addr:</td> <td style="padding: 2px;"> <input type="text" value="224. 0. 0. 2"/> [N/A]                 </td> </tr> <tr> <td style="padding: 2px;">Local/RemotePort Number:</td> <td style="padding: 2px;"> <input type="text" value="123"/> <input type="text" value="456"/> (1~65535)                 </td> </tr> <tr> <td style="padding: 2px;">Timeout Reconnection :</td> <td style="padding: 2px;"> <input type="text" value="0"/> (0~99999)s                 </td> </tr> <tr> <td style="padding: 2px;">PRINT:</td> <td style="padding: 2px;"><input type="checkbox"/></td> </tr> <tr> <td style="padding: 2px;">Modbus Poll:</td> <td style="padding: 2px;"> <input checked="" type="checkbox"/> Response Timeout: <input type="text" value="200"/> (10~9999)ms                 </td> </tr> <tr> <td style="padding: 2px;">Modbus TCP Exception:</td> <td style="padding: 2px;"><input type="checkbox"/></td> </tr> <tr> <td style="padding: 2px;">Enable Net Heartbeat Packet:</td> <td style="padding: 2px;"><input type="checkbox"/></td> </tr> <tr> <td style="padding: 2px;">Registry Type:</td> <td style="padding: 2px;"> <input type="text" value="None"/> Location <input type="text" value="Connect With"/> </td> </tr> <tr> <th style="background-color: #0070C0; color: white;">Socket B</th> <th style="background-color: #0070C0; color: white;">Parameters</th> </tr> <tr> <td style="padding: 2px;">WorkMode:</td> <td style="padding: 2px;"><input type="text" value="NONE"/></td> </tr> </tbody> </table> <div style="text-align: center; margin-top: 5px;"> <input type="button" value="Save"/> <input type="button" value="Cancel"/> </div>	Socket A	Parameters	Work Mode:	<input type="text" value="UDP Client"/> <input type="text" value="Multicast"/>	Remote Server Addr:	<input type="text" value="224. 0. 0. 2"/> [N/A]	Local/RemotePort Number:	<input type="text" value="123"/> <input type="text" value="456"/> (1~65535)	Timeout Reconnection :	<input type="text" value="0"/> (0~99999)s	PRINT:	<input type="checkbox"/>	Modbus Poll:	<input checked="" type="checkbox"/> Response Timeout: <input type="text" value="200"/> (10~9999)ms	Modbus TCP Exception:	<input type="checkbox"/>	Enable Net Heartbeat Packet:	<input type="checkbox"/>	Registry Type:	<input type="text" value="None"/> Location <input type="text" value="Connect With"/>	Socket B	Parameters	WorkMode:	<input type="text" value="NONE"/>	mechanism; you can modify it as a none-zero value
Socket A	Parameters																									
Work Mode:	<input type="text" value="UDP Client"/> <input type="text" value="Multicast"/>																									
Remote Server Addr:	<input type="text" value="224. 0. 0. 2"/> [N/A]																									
Local/RemotePort Number:	<input type="text" value="123"/> <input type="text" value="456"/> (1~65535)																									
Timeout Reconnection :	<input type="text" value="0"/> (0~99999)s																									
PRINT:	<input type="checkbox"/>																									
Modbus Poll:	<input checked="" type="checkbox"/> Response Timeout: <input type="text" value="200"/> (10~9999)ms																									
Modbus TCP Exception:	<input type="checkbox"/>																									
Enable Net Heartbeat Packet:	<input type="checkbox"/>																									
Registry Type:	<input type="text" value="None"/> Location <input type="text" value="Connect With"/>																									
Socket B	Parameters																									
WorkMode:	<input type="text" value="NONE"/>																									
Local IP Config																										
Port1																										
Port2																										
Port3																										
Port4																										
Port5																										
Port6																										
Port7																										
Port8																										
Web to Serial																										
Misc Config																										
Module Mange																										

Copyright © Jinan USR IOT Technology Limited. All Rights Reserved website: [www.usriot.com](http://www.usriot.com)

## 2. Create UDP (Group) connection

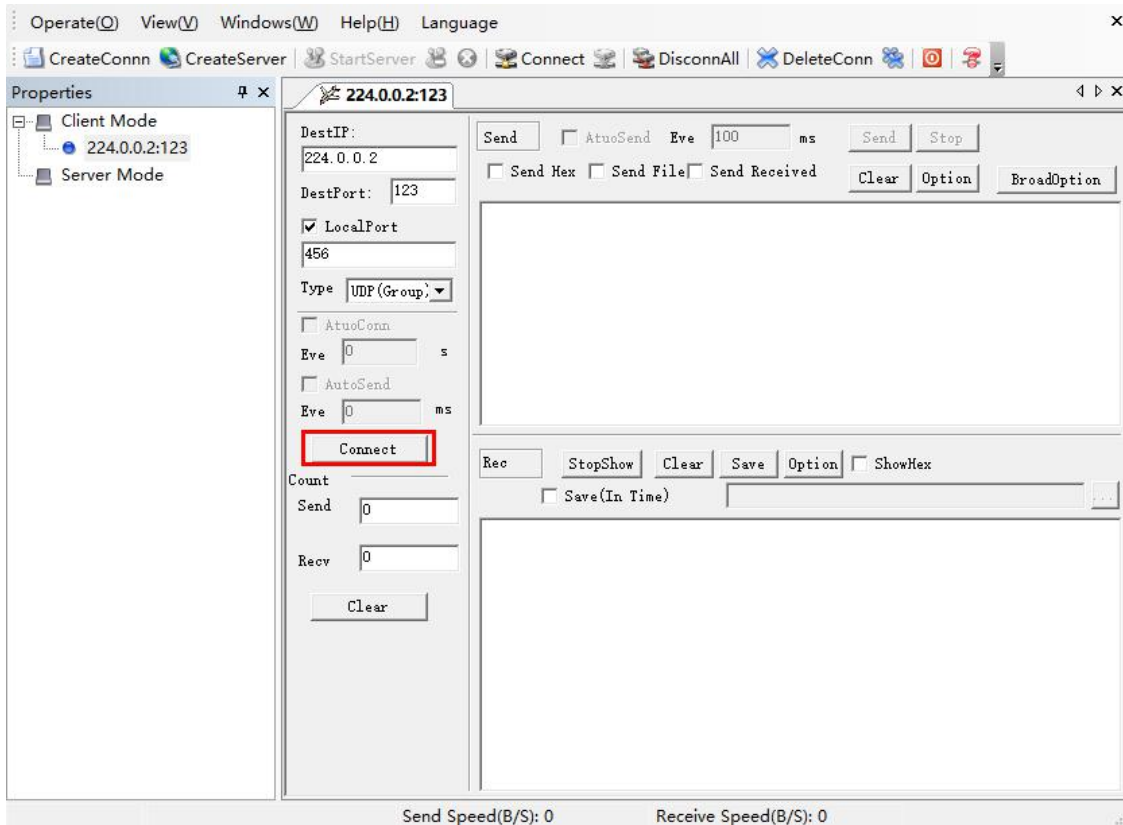
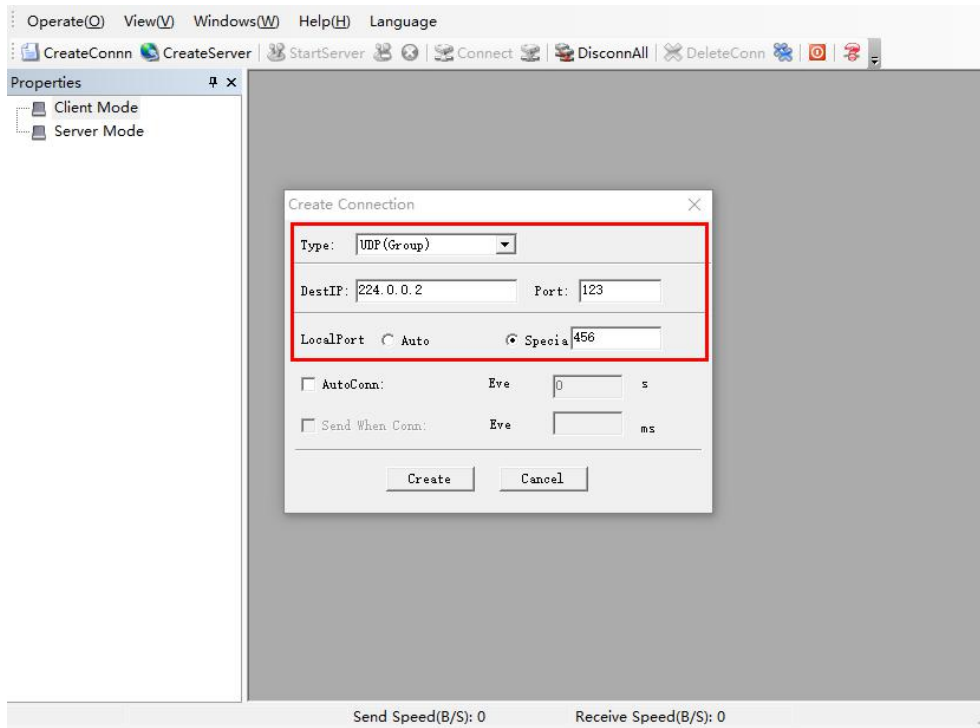

### 3. UDP Group communication

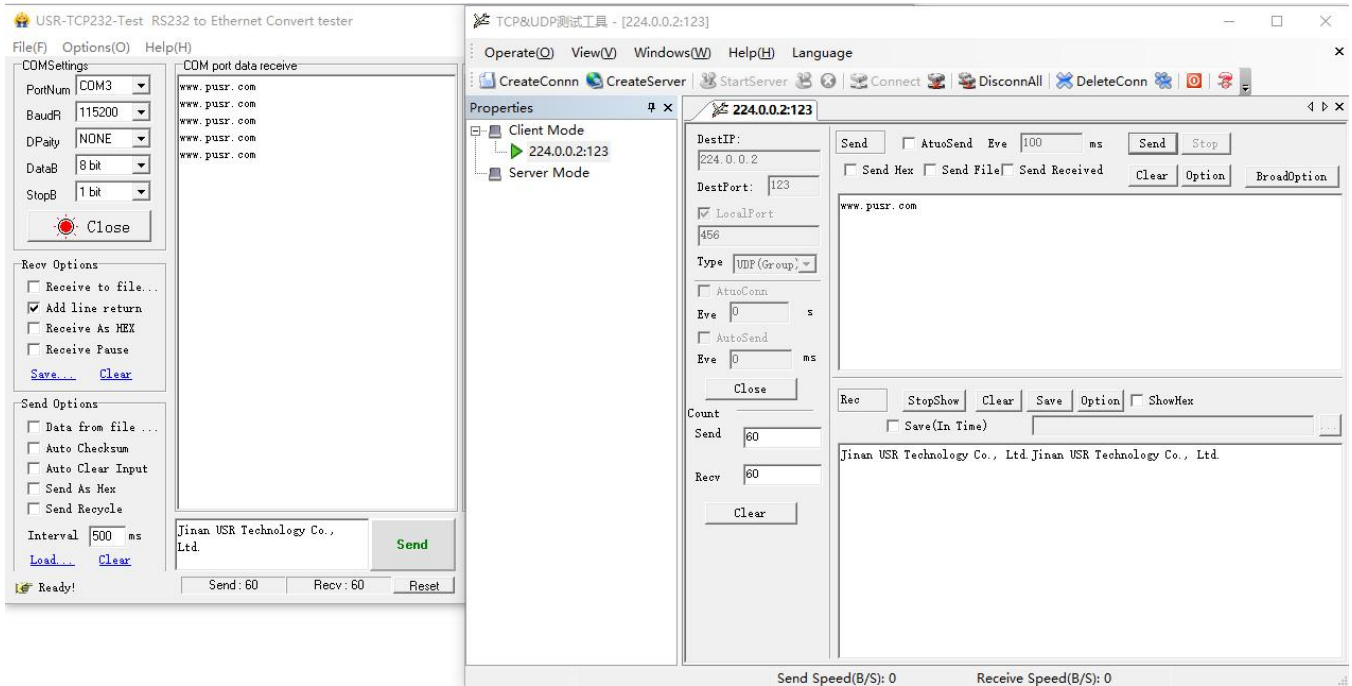

## 5.10 Web Socket

Websocket function can achieve the data transmission between any one serial port and the webpage of N580. You can select the **Websocket Direction** from **UART 1~8** and **LOG**.

1. Data transmission between serial port and webpage:  
Websocket Port defaults to 6432.



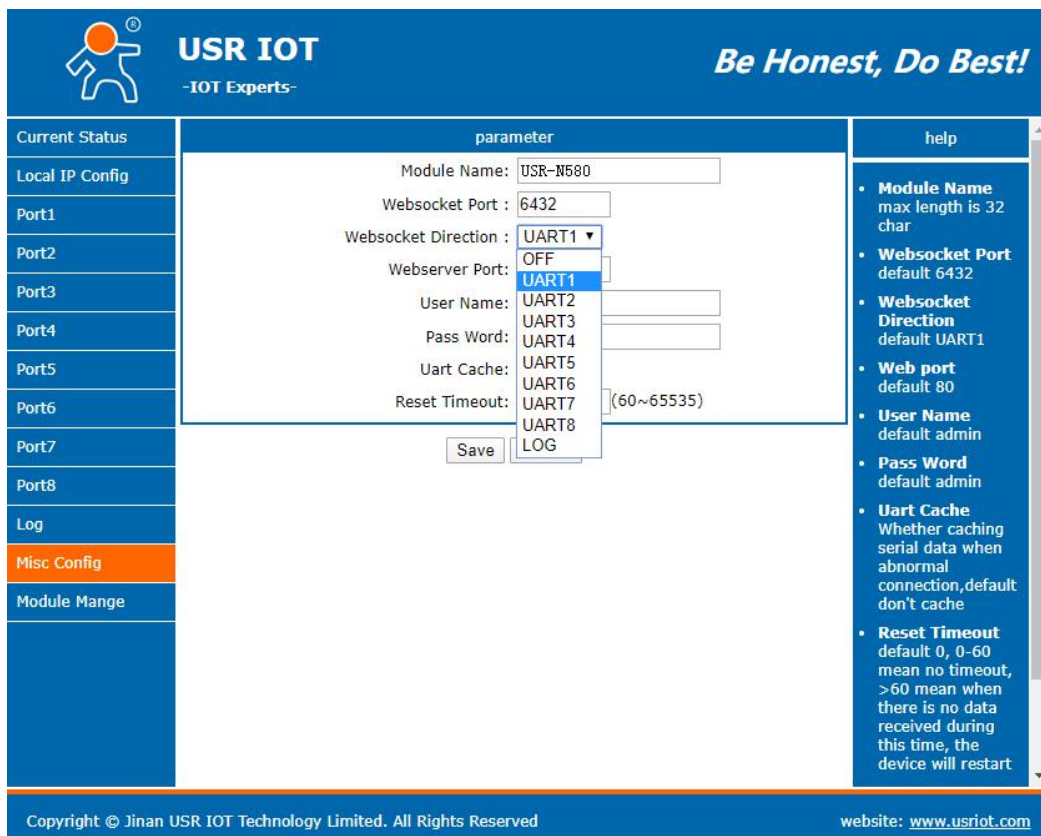

The screenshot shows the USR IOT web interface with the 'parameter' configuration page selected. The left sidebar contains menu items: Current Status, Local IP Config, Port1, Port2, Port3, Port4, Port5, Port6, Port7, Port8, Log, Misc Config (highlighted), and Module Mange. The main content area is titled 'parameter' and contains the following fields:

- Module Name: USR-N580
- Websocket Port: 6432
- Websocket Direction: UART1 (dropdown menu)
- Webserver Port: OFF
- User Name: UART2
- Pass Word: UART4
- Uart Cache: UART5
- Reset Timeout: UART7 (60~65535)

Buttons for 'Save' and 'LOG' are visible at the bottom of the configuration area. A 'help' sidebar on the right provides details for each parameter:

- Module Name**: max length is 32 char
- Websocket Port**: default 6432
- Websocket Direction**: default UART1
- Web port**: default 80
- User Name**: default admin
- Pass Word**: default admin
- Uart Cache**: Whether caching serial data when abnormal connection, default don't cache
- Reset Timeout**: default 0, 0-60 mean no timeout, >60 mean when there is no data received during this time, the device will restart

Copyright © Jinan USR IOT Technology Limited. All Rights Reserved. website: [www.usriot.com](http://www.usriot.com)

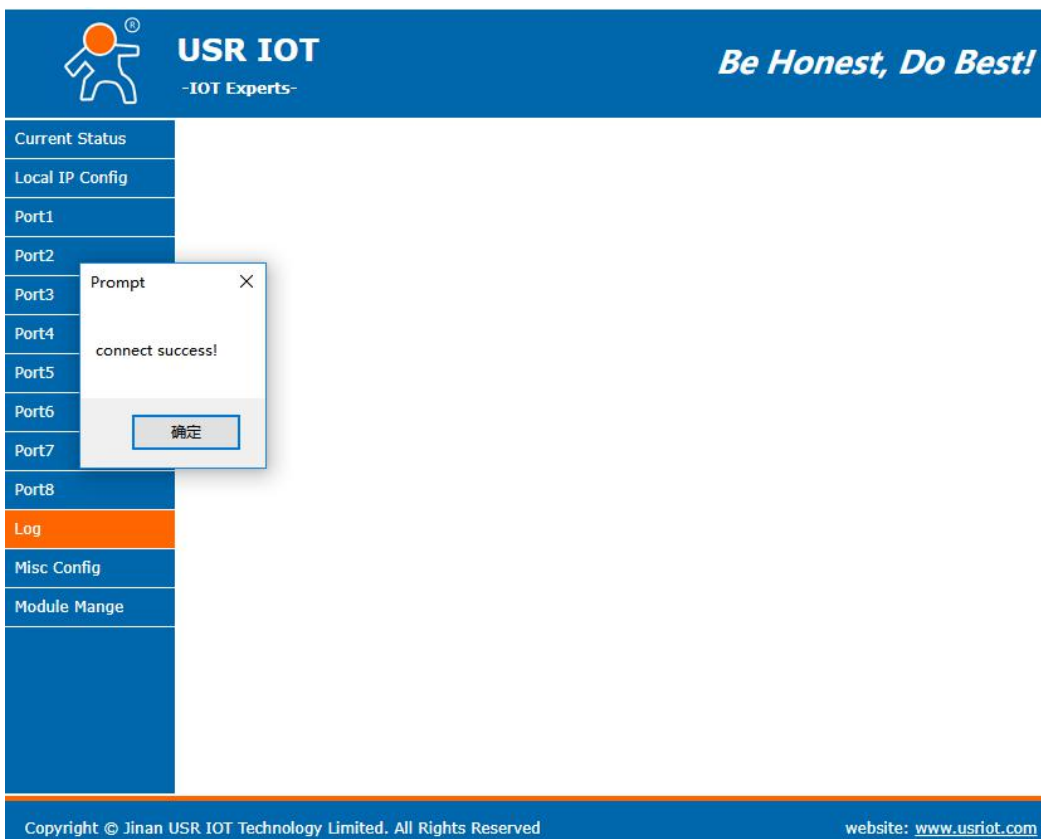

The screenshot shows the USR IOT web interface with the 'Log' page selected. The left sidebar contains menu items: Current Status, Local IP Config, Port1, Port2, Port3, Port4, Port5, Port6, Port7, Port8, Log (highlighted), Misc Config, and Module Mange. A dialog box titled 'Prompt' is displayed in the center of the screen with the message 'connect success!' and a '确定' (OK) button.

Copyright © Jinan USR IOT Technology Limited. All Rights Reserved. website: [www.usriot.com](http://www.usriot.com)

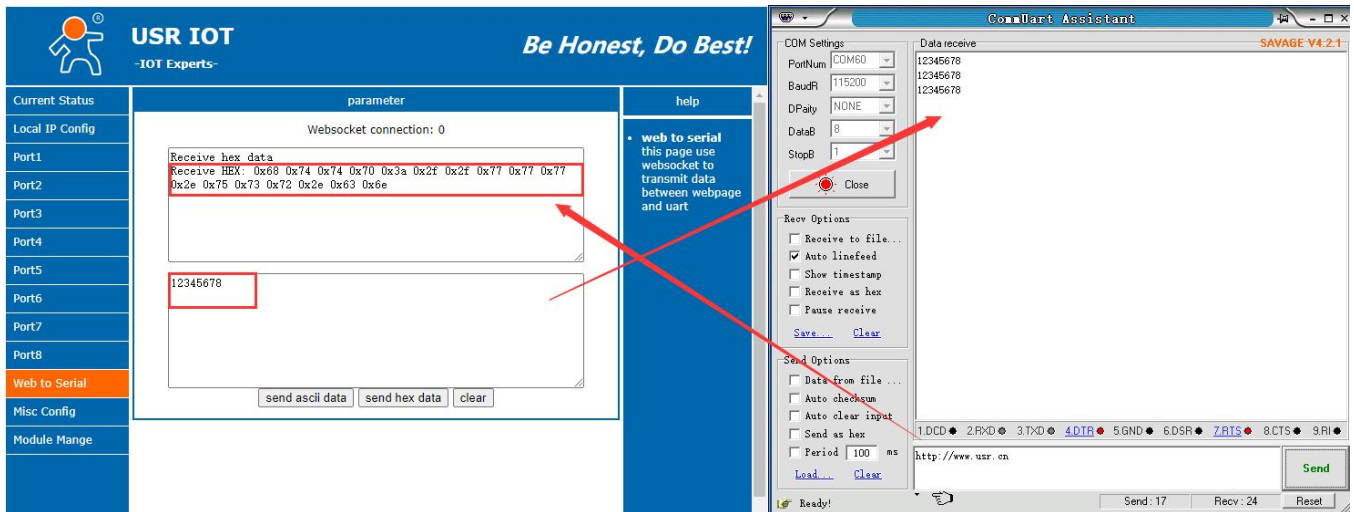

The screenshot displays the USR IOT web interface with the 'Web to Serial' configuration page. The 'parameter' section shows 'Websocket connection: 0' and a text area containing 'Receive hex data' and 'Receive HEX: 0x68 0x74 0x74 0x70 0x3a 0x2f 0x2f 0x77 0x77 0x77 0x2e 0x75 0x73 0x72 0x2e 0x63 0x6e'. Below this, the value '12345678' is displayed. The 'CommUart Assistant' window shows 'Data receive' with '12345678' and '12345678'. Red arrows point from the '12345678' in the web interface to the 'Data receive' field in the 'CommUart Assistant' window.

## 2. LOG

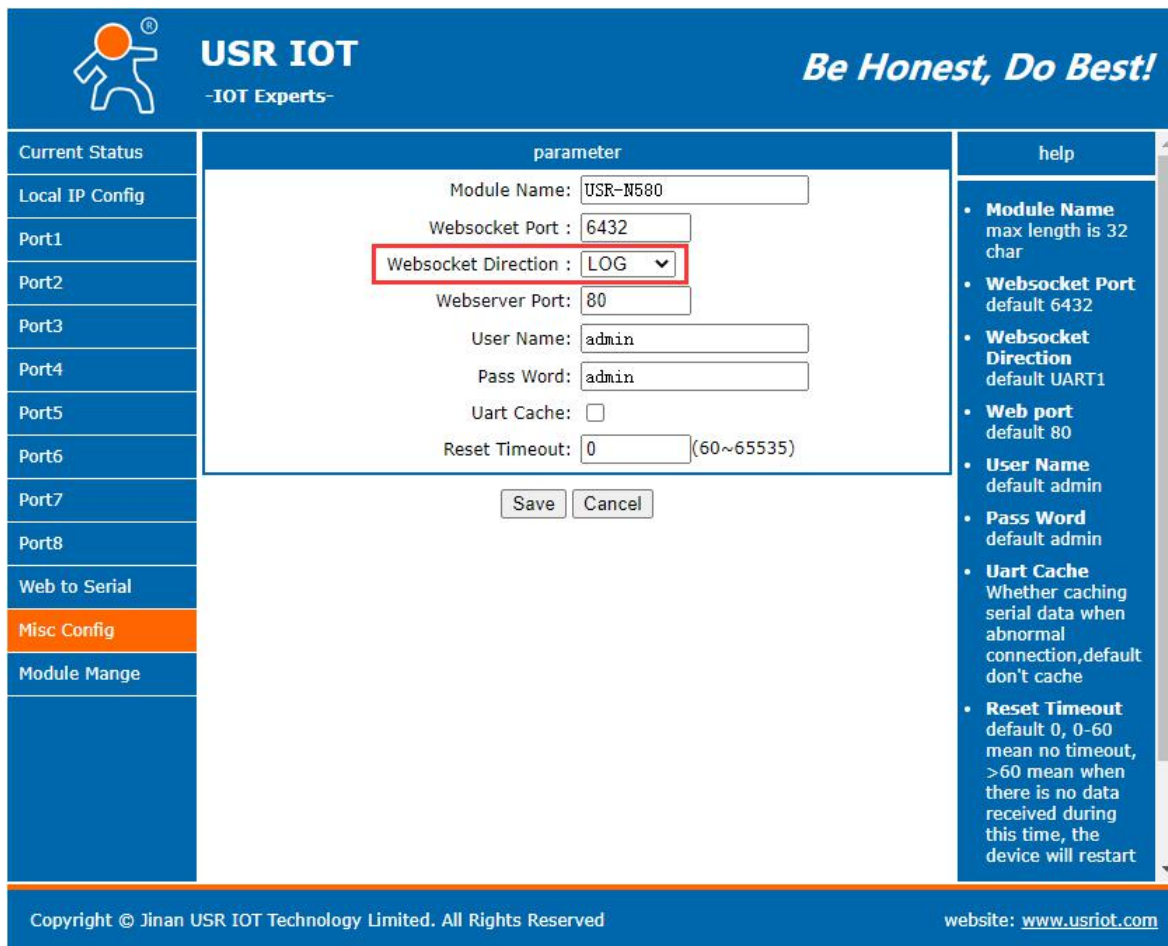

The screenshot displays the USR IOT web interface with the 'Misc Config' page. The 'parameter' section shows the following configuration:

- Module Name: USR-N580
- Websocket Port: 6432
- Websocket Direction: LOG
- Webserver Port: 80
- User Name: admin
- Pass Word: admin
- Uart Cache:
- Reset Timeout: 0 (60~65535)

The 'help' section provides details for each parameter:

- Module Name** max length is 32 char
- Websocket Port** default 6432
- Websocket Direction** default UART1
- Web port** default 80
- User Name** default admin
- Pass Word** default admin
- Uart Cache** Whether caching serial data when abnormal connection, default don't cache
- Reset Timeout** default 0, 0-60 mean no timeout, >60 mean when there is no data received during this time, the device will restart

Copyright © Jinan USR IOT Technology Limited. All Rights Reserved  
website: [www.usriot.com](http://www.usriot.com)

- Query the basic information of the device, there is a carriage return after the command:

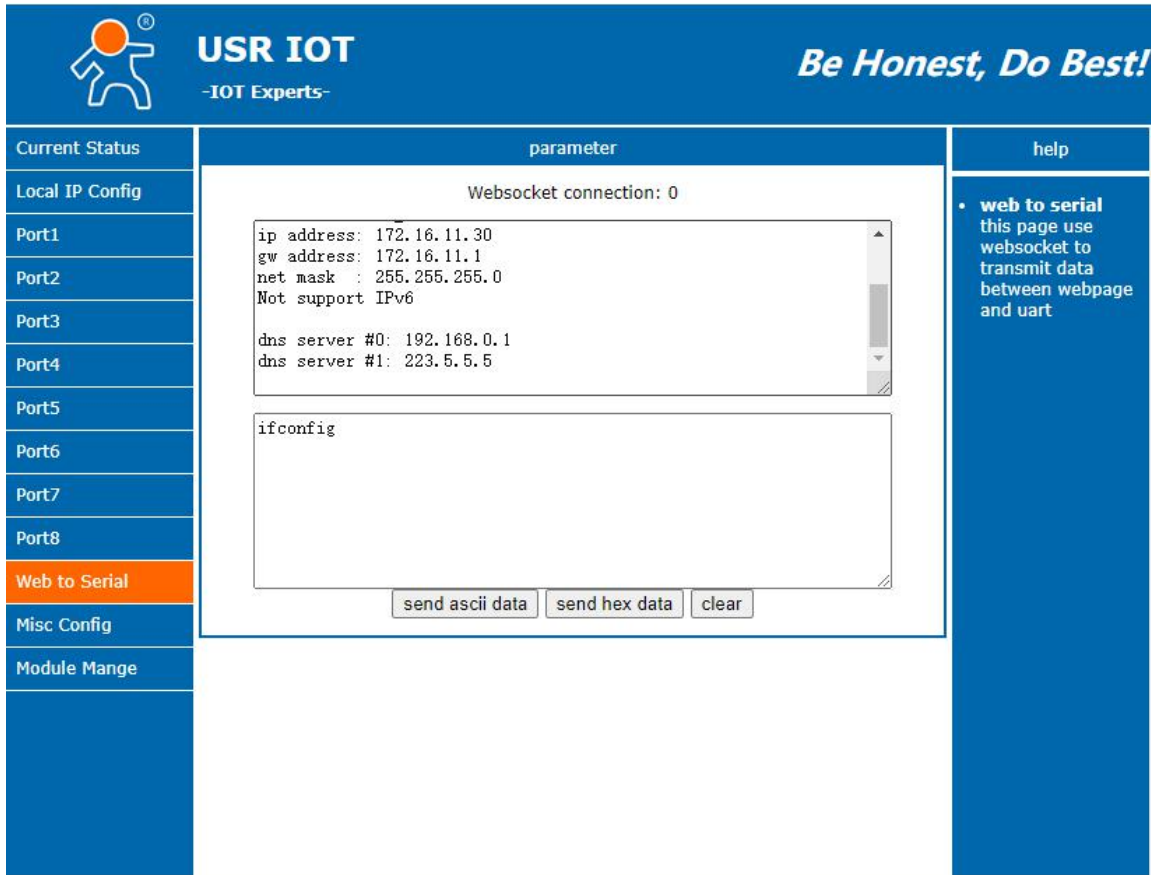

The screenshot shows the USR IOT web interface. The left sidebar contains a menu with items: Current Status, Local IP Config, Port1, Port2, Port3, Port4, Port5, Port6, Port7, Port8, Web to Serial (highlighted), Misc Config, and Module Mange. The main content area is titled 'parameter' and shows 'Websocket connection: 0'. Below this, there are two text areas. The first contains network configuration details: 'ip address: 172.16.11.30', 'gw address: 172.16.11.1', 'net mask : 255.255.255.0', 'Not support IPv6', 'dns server #0: 192.168.0.1', and 'dns server #1: 223.5.5.5'. The second text area contains the command 'ifconfig'. At the bottom of the text areas are buttons for 'send ascii data', 'send hex data', and 'clear'. On the right side, there is a 'help' section with a bullet point: '• web to serial this page use websocket to transmit data between webpage and uart'.

- Check the running condition of the device.  
Set the serial port work mode to TCP Client, remote server address and port are the computer's IP and port.

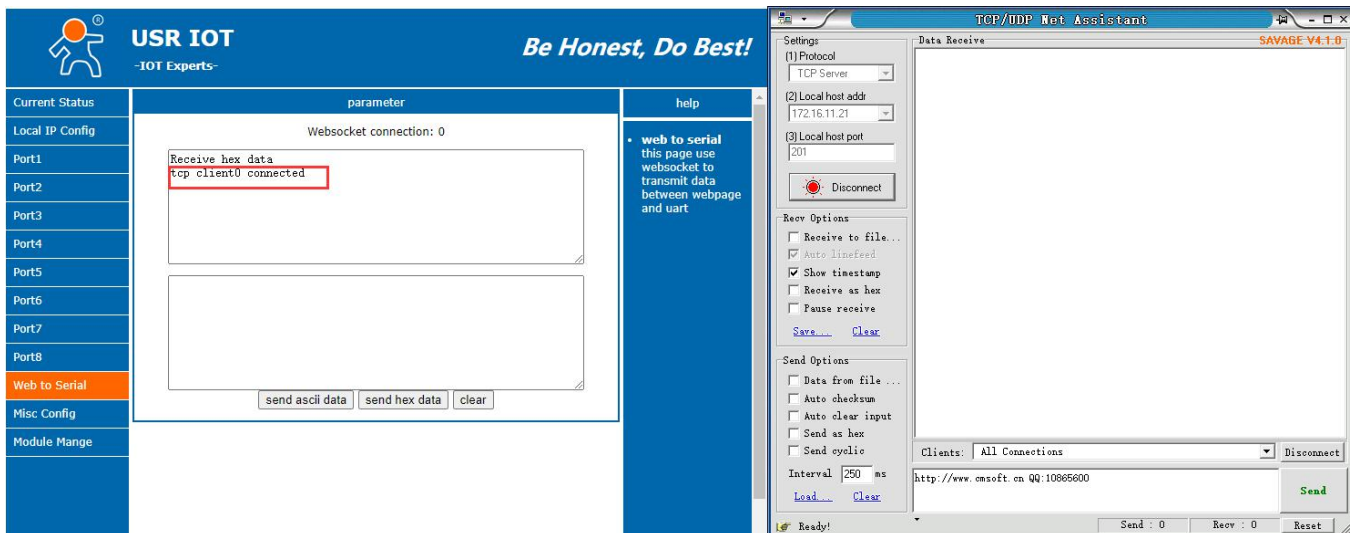

The screenshot shows the USR IOT web interface on the left and a 'TCP/UDP Net Assistant' window on the right. The web interface shows the 'Web to Serial' section with a text area containing 'Receive hex data' and 'tcp client0 connected'. The 'TCP/UDP Net Assistant' window has the following settings: (1) Protocol: TCP Server, (2) Local host addr: 172.16.11.21, (3) Local host port: 201. There are 'Recv Options' (Receive to file, Auto lineFeed, Show timestamp, Receive as hex, Pause receive) and 'Send Options' (Data from file, Auto checksum, Auto clear input, Send as hex, Send cyclic). The 'Clients' list shows 'All Connections' and 'Disconnect'. The 'Interval' is set to 250 ms. The status bar shows 'Send: 0' and 'Recv: 0'.

WebSocket supports below browsers:

Browser	Version
Chrome	Supported in version 4+
Firefox	Supported in version 4+
Internet Explorer	Supported in version 10+
Opera	Supported in version 10+
Safari	Supported in version 5+

## 5.11 Network Printing Function

Network printing function is similar to printer server, it can be realized by the previous serial printer through the existed printing driver.

Testing steps:

1. Configure the parameter, set work mode as "TCP Server", local port number "9100", and have to choose "Net Buffer" and "PRINT". Others do not need to be chosen.

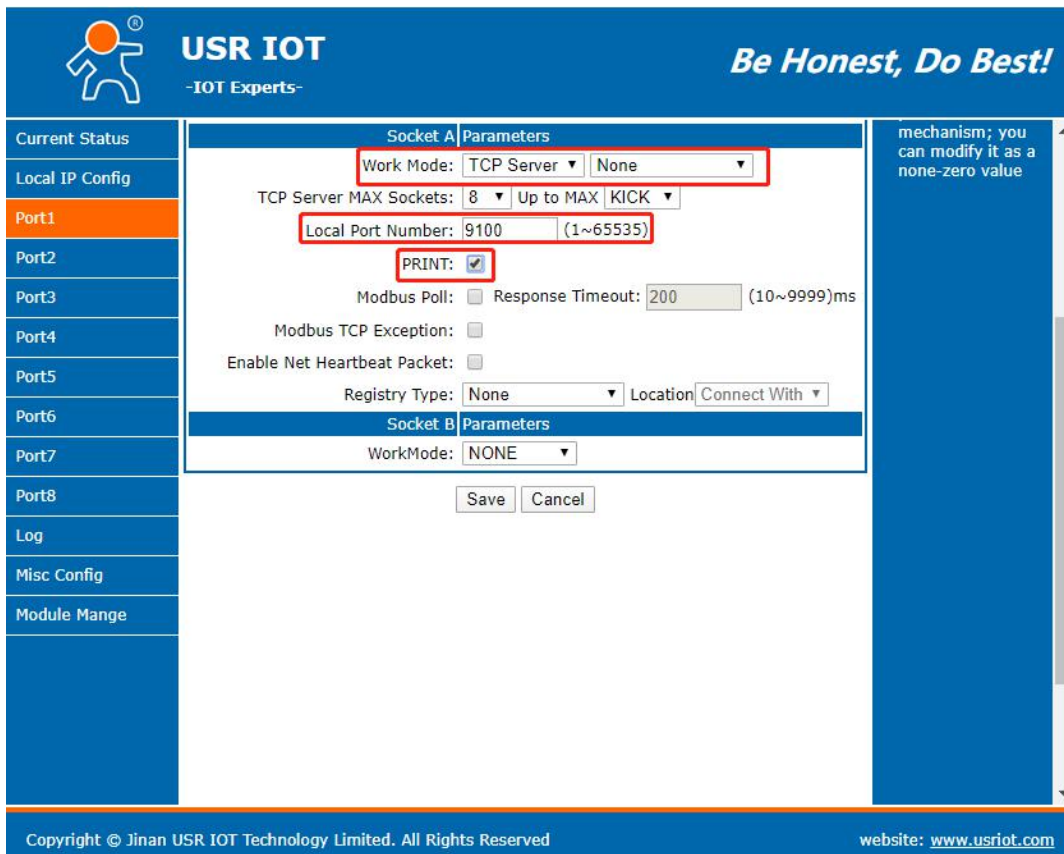

The screenshot shows the USR IOT web interface for configuring network printing. The main content area is titled "Socket A Parameters" and includes the following settings:

- Work Mode:** TCP Server (selected), None
- TCP Server MAX Sockets:** 8 (selected), Up to MAX, KICK
- Local Port Number:** 9100 (selected), (1~65535)
- PRINT:**
- Modbus Poll:**  Response Timeout: 200 (10~9999)ms
- Modbus TCP Exception:**
- Enable Net Heartbeat Packet:**
- Registry Type:** None (selected), Location: Connect With

Below these settings is the "Socket B Parameters" section, where the "WorkMode" is set to NONE. There are "Save" and "Cancel" buttons at the bottom of the configuration area.

The sidebar on the left contains navigation options: Current Status, Local IP Config, Port1 (highlighted), Port2, Port3, Port4, Port5, Port6, Port7, Port8, Log, Misc Config, and Module Mange.

The footer of the interface reads: Copyright © Jinan USR IOT Technology Limited. All Rights Reserved. website: [www.usriot.com](http://www.usriot.com)

2. Set Printer Driver

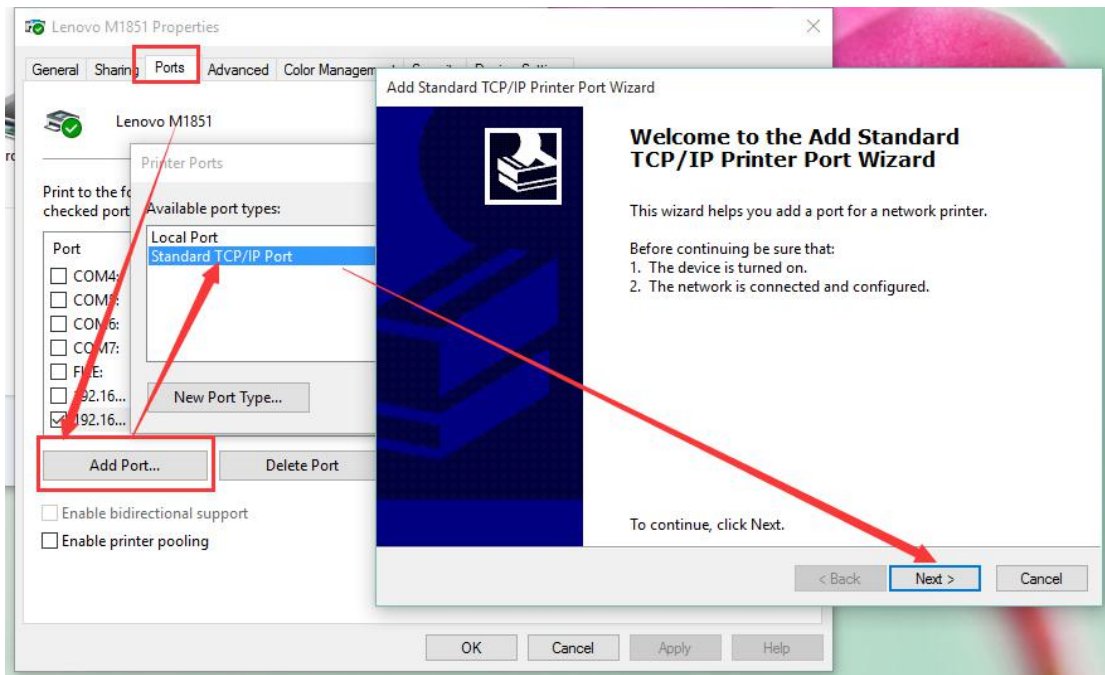
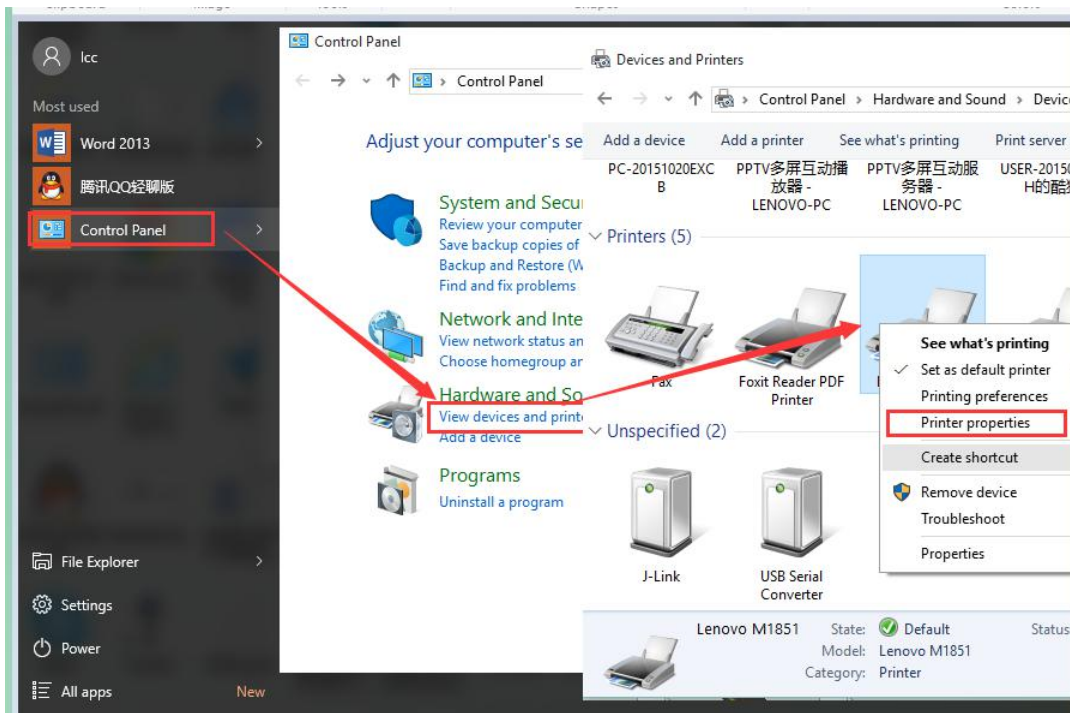

Click next and input the USR-N580's IP address, then keep clicking next till finished.

3. Serial port connects to the printer, open a word file to print.

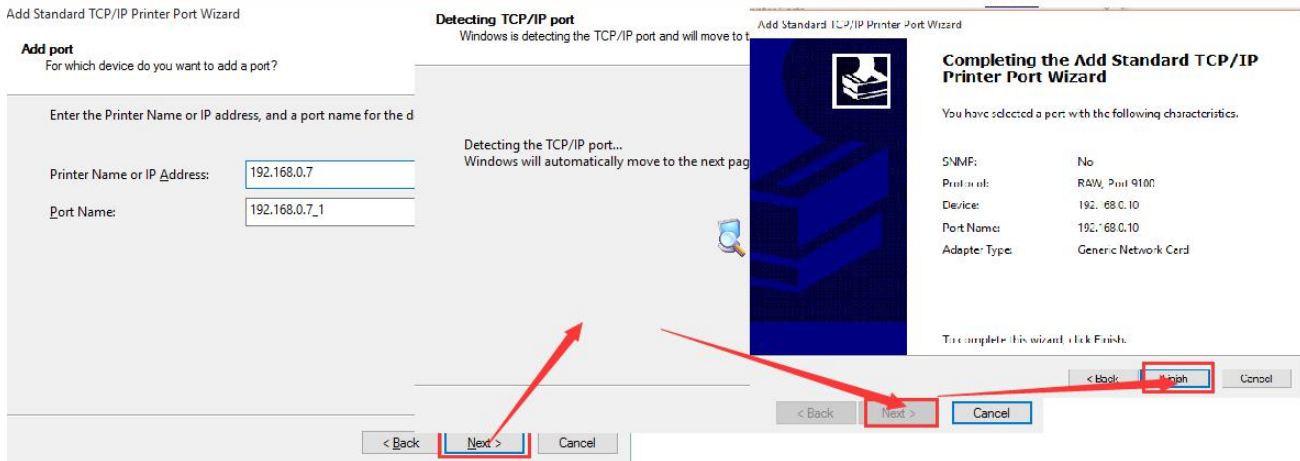

## 6. Virtual Com Software

It solve the transmission problem of traditional device PC software working as COM. USR-VCOM (Virtual com software) support receiving data from set COM and send serial data out as network.

How to connect USR-N580 with Virtual COM:

1. Set USR-N580 as TCP server
2. Open USR-VCOM software, click "Add COM" and select COM2 (Avoid existed COM).

Net Protocol: TCP Client

Remote IP and port are the local IP and port of N580.

Remarks: Can write the name of device

Click "OK" to check whether connection is built. "Connected" sow ready for data transmission.

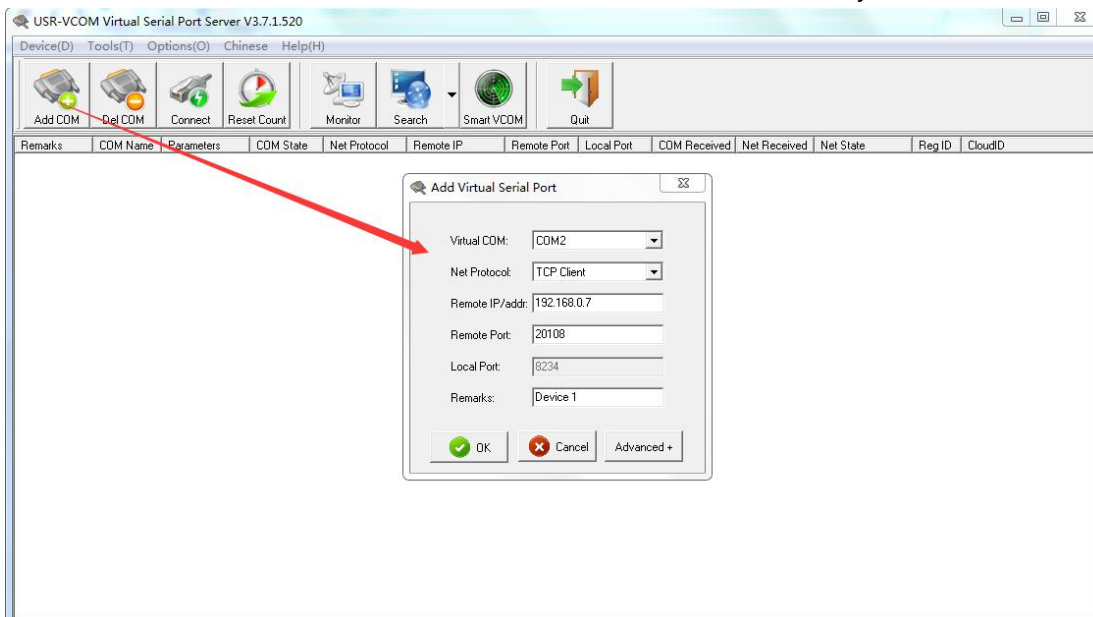

## 7. USR Cloud Platform

USR CLOUD includes cloud configuration and cloud monitoring.

If your serial device supports standard MODBUS RTU data, the cloud platform can display serial device data by establishing a TCP connection with the N580 device.

USR Cloud address: <https://mp.usriot.com> After registering an account, log in.

Parameter settings in N580 device:

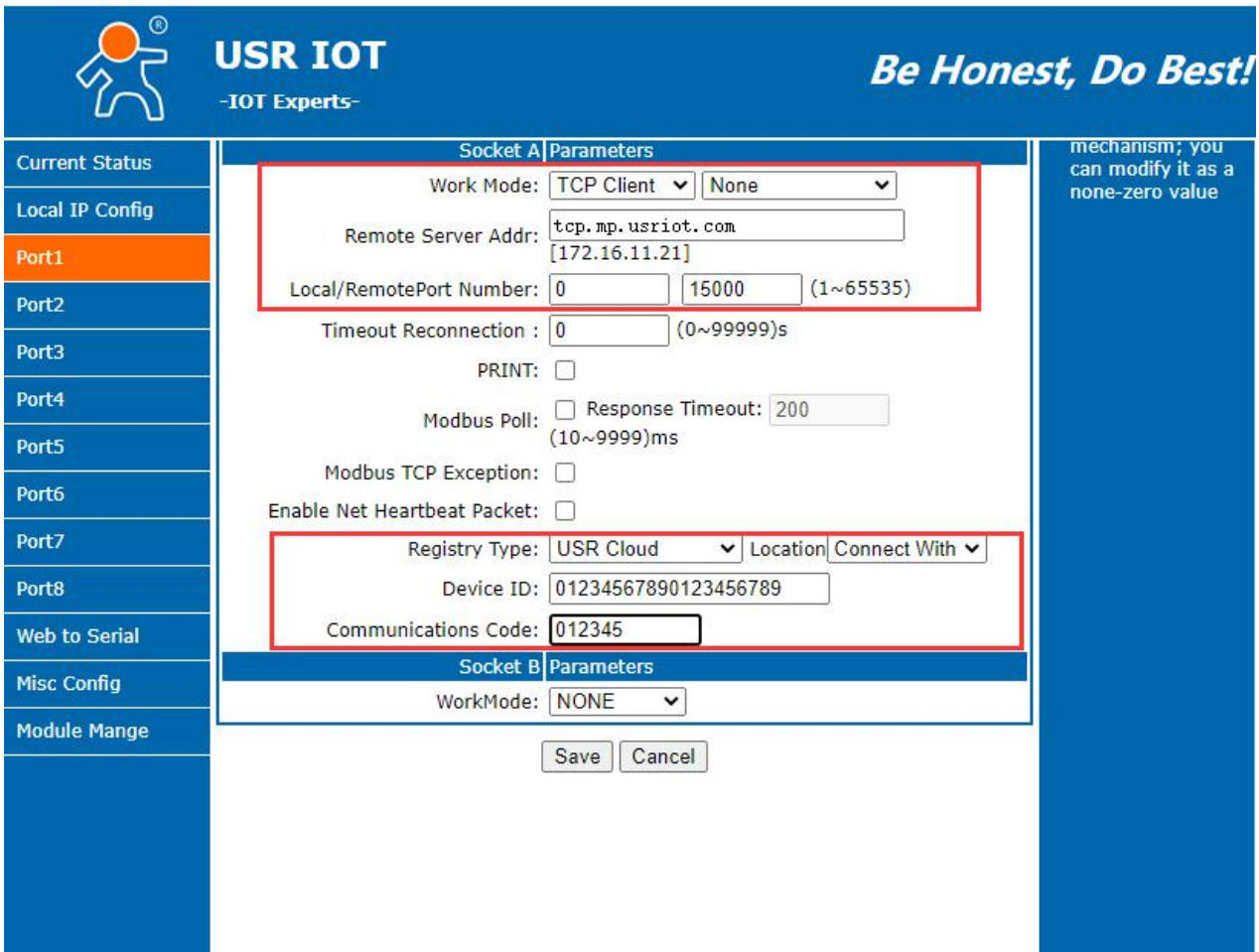

**USR IOT**  
-IOT Experts-  
*Be Honest, Do Best!*

Current Status	Socket A Parameters
Local IP Config	Work Mode: TCP Client   None
<b>Port1</b>	Remote Server Addr: tcp.mp.usriot.com [172.16.11.21]
Port2	Local/RemotePort Number: 0   15000 (1~65535)
Port3	Timeout Reconnection : 0 (0~99999)s
Port4	PRINT: <input type="checkbox"/>
Port5	Modbus Poll: <input type="checkbox"/> Response Timeout: 200 (10~9999)ms
Port6	Modbus TCP Exception: <input type="checkbox"/>
Port7	Enable Net Heartbeat Packet: <input type="checkbox"/>
Port8	Registry Type: USR Cloud   Location   Connect With
Web to Serial	Device ID: 01234567890123456789
Misc Config	Communications Code: 012345
Module Mange	Socket B Parameters
	WorkMode: NONE

mechanism; you can modify it as a none-zero value

Save Cancel

## 8. AT Command Set

For details, please refer to the document: **AT command set**.

## 9. Disclaimer

No part of this document may be reproduced in any form without the written permission of the copyright owner. The contents of this document are subject to change without notice due to continued progress in methodology, design and manufacturing. PUSR shall have no liability for any error or damage of any kind resulting from the use of this document.