

MD-219 Hardware Manual

First Edition, October 2014

www.moxa.com/product

MOXA[®]

© 2014 Moxa Inc. All rights reserved.

MD-219 Hardware Manual

The software described in this manual is furnished under a license agreement and may be used only in accordance with the terms of that agreement.

Copyright Notice

© 2014 Moxa Inc. All rights reserved.

Trademarks

The MOXA logo is a registered trademark of Moxa Inc.
All other trademarks or registered marks in this manual belong to their respective manufacturers.

Disclaimer

Information in this document is subject to change without notice and does not represent a commitment on the part of Moxa.

Moxa provides this document as is, without warranty of any kind, either expressed or implied, including, but not limited to, its particular purpose. Moxa reserves the right to make improvements and/or changes to this manual, or to the products and/or the programs described in this manual, at any time.

Information provided in this manual is intended to be accurate and reliable. However, Moxa assumes no responsibility for its use, or for any infringements on the rights of third parties that may result from its use.

This product might include unintentional technical or typographical errors. Changes are periodically made to the information herein to correct such errors, and these changes are incorporated into new editions of the publication.

Technical Support Contact Information

www.moxa.com/support

Moxa Americas

Toll-free: 1-888-669-2872
Tel: +1-714-528-6777
Fax: +1-714-528-6778

Moxa Europe

Tel: +49-89-3 70 03 99-0
Fax: +49-89-3 70 03 99-99

Moxa India

Tel: +91-80-4172-9088
Fax: +91-80-4132-1045

Moxa China (Shanghai office)

Toll-free: 800-820-5036
Tel: +86-21-5258-9955
Fax: +86-21-5258-5505

Moxa Asia-Pacific

Tel: +886-2-8919-1230
Fax: +886-2-8919-1231

Table of Contents

1. Introduction	1-1
Overview	1-2
Ordering Information	1-2
Package Checklist	1-2
Product Features	1-3
MD-219 Hardware Specifications	1-3
2. Hardware Introduction	2-1
Appearance and Layout	2-2
Dimensions	2-3
SavvyTouch Display Control Buttons	2-3
3. Hardware Connection Description	3-1
Placement Guidelines	3-2
Installation Notes	3-2
Desktop Mounting	3-3
Panel Mounting	3-4
VESA Mounting	3-5
Safety Precautions	3-6
Grounding the MD-219 Series	3-6
Powering on/off the MD-219 Series	3-7
SavvyTouch Display Control Buttons	3-7
Connecting Data Transmission Cables	3-9
Connecting the MD-219 to a Computer	3-9
Enabling the Touch Screen Interface (Z models only)	3-9
Connecting Video Input Cables	3-10
Connecting the Built-in Buzzer	3-11
4. Touch Function	4-1
Installing Touch Function Driver	4-2
Performing Screen Calibration	4-7
5. Display Control Interface	5-1
Connecting to the UART Control Interface	5-2
UART Command Format	5-4
Command Format Details	5-4
Downloading RGB Files	5-6
VGA	5-6
DVI	5-6
A. Regulatory Approval Statement	A-1
B. On-Screen Display (OSD) Controls	B-1
Opening the Configuration Screen	B-2
OSD Menu Map and Items Explained	B-2
Source – Auto Source	B-2
Image Setting – Auto Setup	B-2
Image Setting – Display	B-3
Color Mode – Color Temperature	B-3
Color Mode – Color Temperature – User	B-3
Management – Communication	B-4
OSD Misc – OSD position	B-4
OSD Misc – Language	B-5
OSD Misc – Preset Save	B-5
OSD Misc – OSD Lock Mode	B-5
Service	B-6
Service – Test Pattern	B-6
C. Display UART Commands	C-1
OSD Control Command	C-2
BRI (Brightness Minimum Value)	C-2
BRL (Set LED Brightness of Touch Keypad)	C-2
BRM (Brightness Maximum Value)	C-2
BRT (User Brightness Control)	C-2
BRU (Glass Display Control-Brightness Button)	C-3
BZZ (Buzzer Control)	C-3
DLN (Download ECDIS RGB File)	C-3
DL? (ECDIS RGB Package Query)	C-4
D2N (Download ECDIS RGB File (Second))	C-4
D2? (ECDIS RGB Package Query (Second))	C-4
ETC (Elapsed Time Counter Query)	C-4
GMB (Glass Display Control - Minimum Brightness)	C-5

POT (Potentiometer Control)	C-5
SWI (Scalar Firmware Version Query)	C-5
SWK (Touch Keypad Firmware Version Query)	C-5
ADF (AC Input Power Detect Function)	C-5
AD? (Query AC Input Power Detect Function Status)	C-6
DDF (DC Input Power Detect Function)	C-6
DD? (Query DC Input Power Detect Function Status)	C-6
BLI (Brightness Control)	C-6
DUF (Disable UART Command Function)	C-7
EMS (ECDIS Mode Select)	C-7
CT? (Current Temperature Query)	C-8
SS? (System Status Query)	C-8
MCC (OSD Control Command)	C-8

Introduction

The MD-219 series displays are designed to fit the great demands of the marine industry. The 19-inch wide viewable image size with 5:4 aspect ratio and 1280 x 1024 pixel resolution make the displays ideal for a variety of marine applications. With full range dimming, optical bonding (optional), and wide angle viewing, these computer display terminals meet required marine standards and are perfectly suited for a variety of marine applications, both indoors and outdoors.

These displays use either AC or DC power inputs, simplifying the installation of the displays at field sites.

MD-219 displays are compliant with a wide variety of industrial marine standards, including IEC 60945, DNV, and IACS-E10, lending greater credence to their suitability for maritime operations.

The following topics are covered in this chapter:

- ❑ **Overview**
- ❑ **Ordering Information**
- ❑ **Package Checklist**
- ❑ **Product Features**
- ❑ **MD-219 Hardware Specifications**

Overview

The MD-219 Series is the 19-inch version of our marine display series. Designed for durably reliable service as an ECDIS (Electronic Chart Display and Information System) display component, the MD-219 Series has a 5:4 aspect ratio, alongside full range dimming and optional optical bonding, making the displays well-suited not only for ECDIS applications, but for a variety of other bridge applications, as well.

The MD-219 Series features both AC and DC power inputs, and may be conveniently installed on any bridge, without the need for extra hardware.

Moxa's marine displays are compliant with the most important industrial marine standards, including IEC 60945, DNV, and IACS-E10, giving strong assurance of their suitability for marine applications.

Ordering Information

Available Models

MD-219X: 19-inch, 5:4 aspect ratio display (1280x1024), LED backlight, DVI-D/VGA, RS-232 & RS-422/485 serial ports, AC/DC dual power

MD-219Z: 19-inch, 5:4 aspect ratio display (1280x1024), projected capacitive multi-touch, LED backlight, DVI-D/VGA, RS-232 & RS-422/485 serial ports, AC/DC dual power

Optional Accessories (can be purchased separately)

- Desktop mounting kit
- Panel mounting clamps
- VESA mounting kit

Package Checklist

Each model is shipped with the following items:

- MD-219 display
- VGA cable
- DVI-D cable
- 2-pin terminal block x 1
- 5-pin terminal block x 2
- Documentation and software CD
- Quick installation guide (printed)
- Warranty card

NOTE Please notify your sales representative if any of the above items are missing or damaged.

Product Features

The MD-219 display has the following features:

- 19-inch display
- Color calibrated for ECDIS compliance
- Fanless design
- SavvyTouch display controls
- RS-232 and RS-422/485 serial ports for sending UART commands to configure display settings
- Dual AC/DC power supply units
- Optically bonded and touch panel models available on request

MD-219 Hardware Specifications

Display

Panel Size: 19" viewable image size

Panel Type: MVA

Aspect Ratio: 5:4

Pixels: 1280 x 1024 (SXGA)

Response Time: 20 ms (gray to gray)

Contrast Ratio: 2000:1

Light Intensity: 300 cd/m²

Viewing Angles: 178°/178°

Active Display Area: 376.32 (H) x 301.06 (V) mm

Max Colors: 16.7M / 8-bit color

Display Interface: VGA input x 1, DVI-D input x 1

Resolution:

- VGA: 640 x 480
- SVGA: 800 x 600
- XGA: 1024 x 768
- XGA+: 1152 x 864
- WXGA: 1280 x 768
- SXGA: 1280 x 1024

Serial Interface

Serial Standards: 1 RS-232 port (DB9), 1 RS-422/485 port (terminal block)

Optical Isolation Protection: 4 kV

Serial Signals

RS-232: TxD, RxD, DTR, DSR, RTS, CTS, DCD, GND

RS-422: TxD+, TxD-, RxD+, RxD-, GND

RS-485-2w: Data+, Data-, GND

Front Panel

LEDs: MENU, Brightness, INFO, ECDIS, Day/Dusk/Night

Smart OSD: Yes

Physical Characteristics

Housing: Aluminum sheet metal

Weight: 7.8 kg

Dimensions: 429 x 387 x 75 mm (16.89 x 15.24 x 2.95in)

Mounting: VESA, panel, and dektop (temporary)

Environmental Limits

Operating Temperature: -15 to 55°C (5 to 131°F)

Storage Temperature: -20 to 60°C (-4 to 140°F)

Ambient Relative Humidity: 5 to 95% (non-condensing)

IP Rating:

- Front: IP 54
- Rear: IP 22

Anti-Vibration:

- 0.7 g @ DNV 2.4 (Class A), sine wave, 2-100 Hz, 1 Oct./min., 1.5 hr per axis
- 1 Grms @ DNV 2.4, random wave, 3-100 Hz, 2.5 hr per axis
- 2.1 g @ DNV 2.4 (Class C), sine wave, 2-50 Hz, 1 Oct./min., 1.5 hr per axis

Power Requirements**Input Voltage:**

- DC: 24 VDC (with tolerance from 18 to 30 VDC, 2-pin terminal block)
- AC: 100 to 240 VAC

Power Consumption: 40 W (max.)

Standards and Certifications

Safety: UL/cUL, CCC

EMC: EN 55022 Class B, EN 55024-4-2, EN 55024-4-3, EN 55024-4-4, FCC Part 15 Subpart B Class A

Marine Standard: IEC-60945 4th, IEC-61162, IEC-61174

Marine Type Approval: DNV 2.4 and IACS E10, ABS

Green Product: RoHS, cRoHS, WEEE

Warranty

Warranty Period: 1 year

Details: See www.moxa.com/warranty

We recommend taking the following precautions to minimize heat build-up within the display:

- Position the display within $\pm 40^\circ$ of the vertical
- If (a) the display is not positioned within $\pm 40^\circ$ of the vertical, (b) the ambient temperature exceeds 25°C , or (c) the display is used in a location with minimal ventilation, then install an external fan to increase airflow upwards through the chassis

Important Safety Precaution:

Even though the display is rated to operate within the IEC 60945 standard of -15 to 55°C for bridge applications, it is best to ensure that the ambient temperature does not exceed 25°C . Doing so will significantly increase the lifespan of your display and reduce service costs.

Hardware Introduction

The MD-219 Series display is compact, well-designed, and ruggedized for marine applications. The intelligent SavvyTouch display control buttons allow you to see control buttons easily in low light environments and identify system hardware failures easily. Multiple serial ports allow you to configure display parameters, and the reliable and stable hardware platform lets you devote your attention to developing your applications.

The following topics are covered in this chapter:

- ❑ **Appearance and Layout**
- ❑ **Dimensions**
- ❑ **SavvyTouch Display Control Buttons**

Appearance and Layout

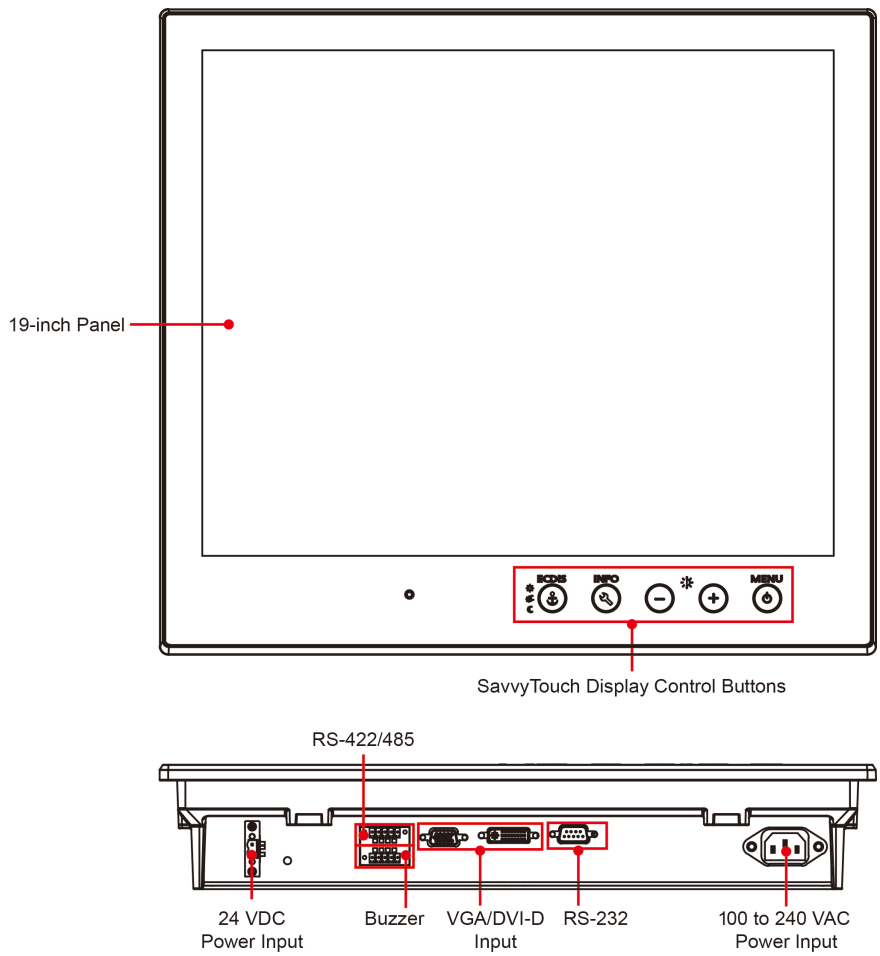



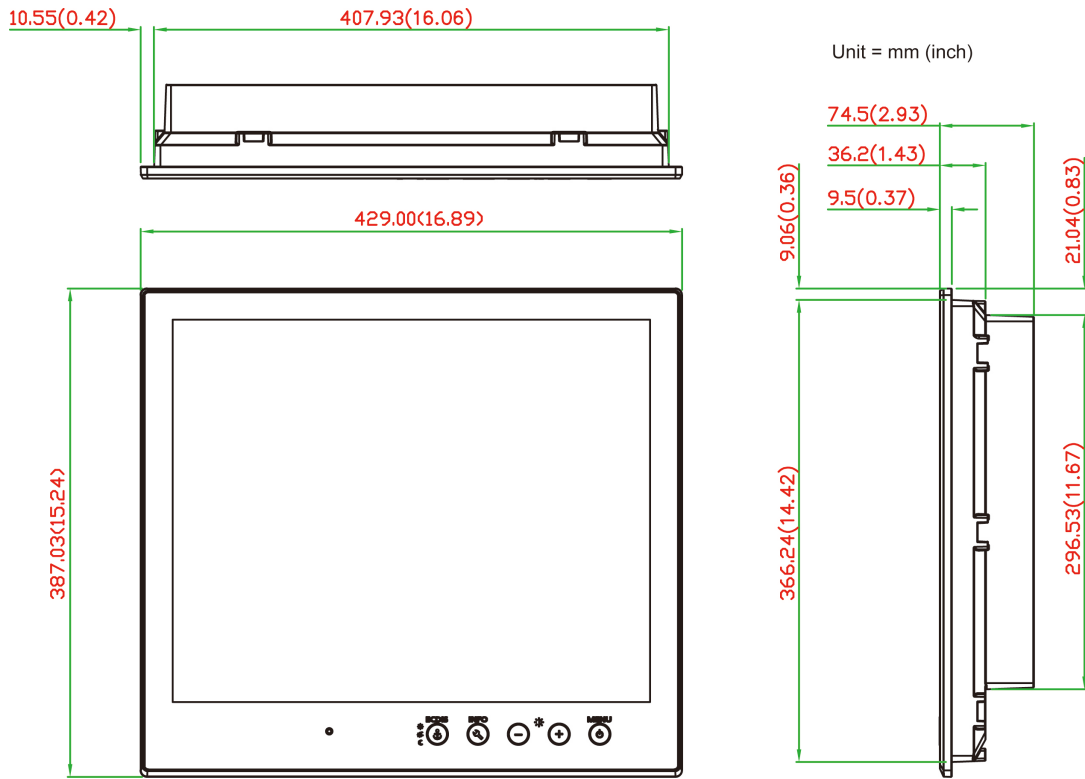

Dimensions



SavvyTouch Display Control Buttons

The MD-219 comes with SavvyTouch display control buttons located at the lower right corner of the front surface. These intelligent buttons will light up automatically when your fingers draw near. Refer to the following table for the function of each button.

Name	Display Color	Control Function / Color Legend
 Menu/Power	Green	Display is powered on and functioning normally. Touch the button to show the OSD settings menu.
	Red	No input signal detected. Display on standby.
	Off	Power is down and the display is off.
 Brightness	White	+: To increase brightness of panel
		-: To decrease brightness of panel
 Info	Off	AC/DC power fuSnctioning normally
	Red	AC/DC power error
 Display mode	White	Switch between DAY/DUSK/NIGHT brightness modes
	Off	Panel brightness out of default range

Hardware Connection Description

In this chapter, we show how to correctly install the MD-219 display using various mounting kits, how to connect the different types of cables, and how to enable functions.

The following topics are covered in this chapter:

- ❑ **Placement Guidelines**
- ❑ **Installation Notes**
 - Desktop Mounting
 - Panel Mounting
 - VESA Mounting
- ❑ **Safety Precautions**
- ❑ **Grounding the MD-219 Series**
- ❑ **Powering on/off the MD-219 Series**
 - SavvyTouch Display Control Buttons
- ❑ **Connecting Data Transmission Cables**
 - Connecting the MD-219 to a Computer
- ❑ **Enabling the Touch Screen Interface (Z models only)**
- ❑ **Connecting Video Input Cables**
- ❑ **Connecting the Built-in Buzzer**

Placement Guidelines

Before installing and mounting the MD-219 display, please read the following notes:

1. The MD-219 series is designed for various installation or mounting methods, including desktop mounting, panel mounting, and VESA mounting. Please refer to the relevant mechanical drawings in the next sections.
2. Good ventilation is necessary to prolong the life of the product. The chassis heat-sink area **MUST** keep clear from other heat generating items, or the motherboard could be damaged. The minimum distance is 150 mm.
3. Keep sufficient space for ventilation improvement, cable inlet or wiring installation, and maintenance purposes.
4. **DO NOT** install the unit in a horizontal position (laying down), since the heat from inside the unit will not dissipate effectively, resulting in damage to the LCD panel. We recommend installing the unit in a vertical position (± 30 degrees) for better heat dissipation.
5. Exposure to extreme direct sunlight may cause a considerable increase in the temperature of the unit, and under certain circumstances might cause the temperature to increase beyond the recommended value. Be sure to keep this point in mind when planning the placement of bridge equipment (sun shades, distance from the windows, ventilation, etc.).
6. Exposure to strong vibration or acoustic noise might affect functionality and expected lifetime. During system assembly and installation, be sure to mount the display carefully to avoid exposure to amplified vibrations.
7. For maximum safety, at least two people should work together to lift, place, and fasten the display to its mounting point. Before you lift or move the display, first verify that any power to the system is turned off. In addition, make sure you have prepared the correct screws for panel mounting.

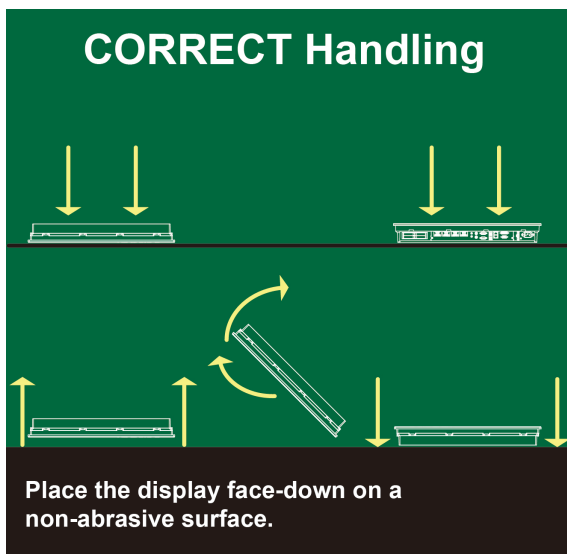

Installation Notes

Follow these steps when installing the MD-219:

1. Fasten the mounting kit on the display first, and then mount the display.
2. Connect cables (DVI-D, VGA, Power cord, etc).
3. Power on the MD-219 display, and then power on the computer.

Desktop Mounting

The MD-219 comes with optional brackets that allow you to install it on a horizontal surface, such as a desktop. Three round screws are required for each bracket. See the figure below for detailed screw specifications and their torque values.

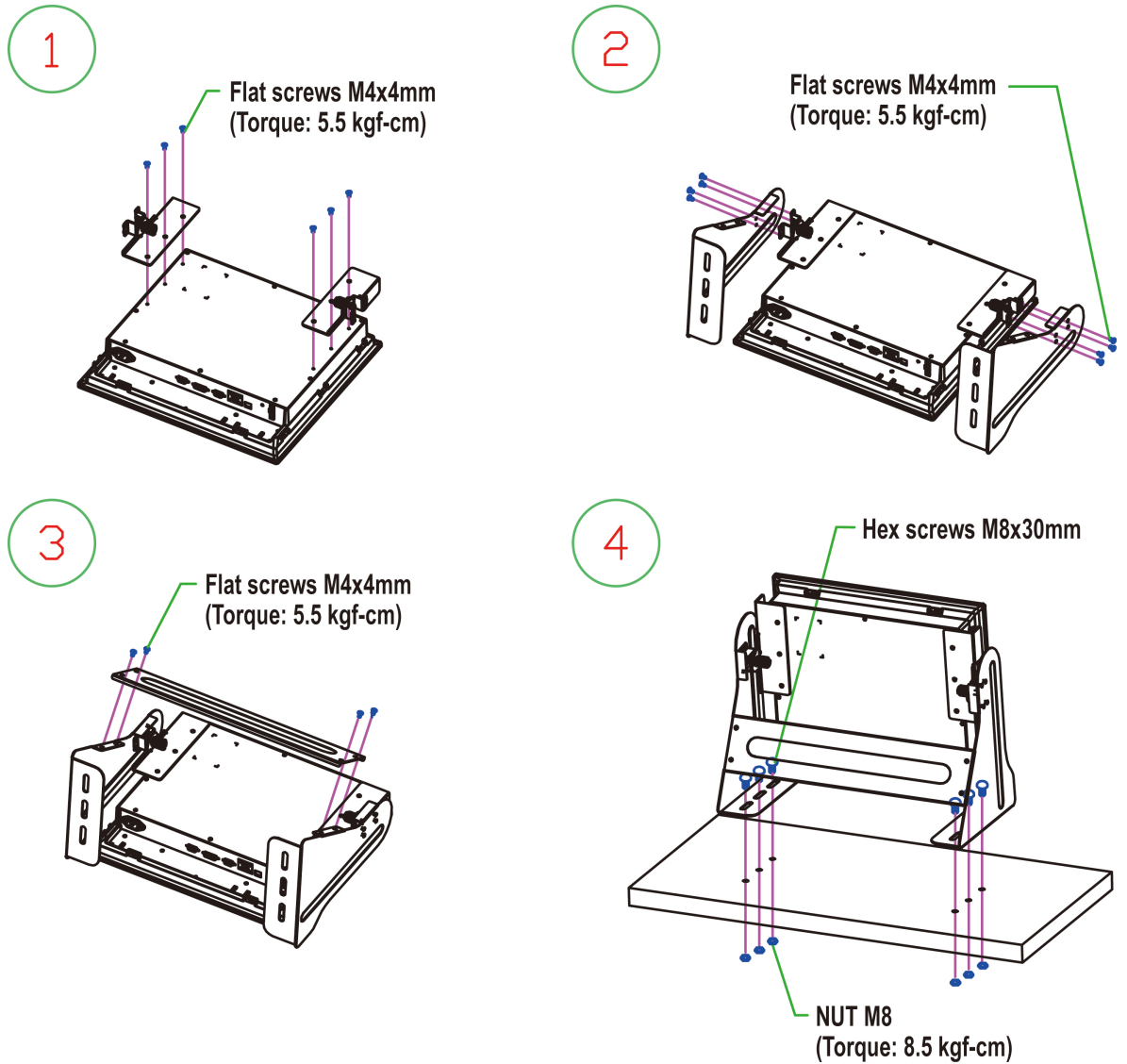

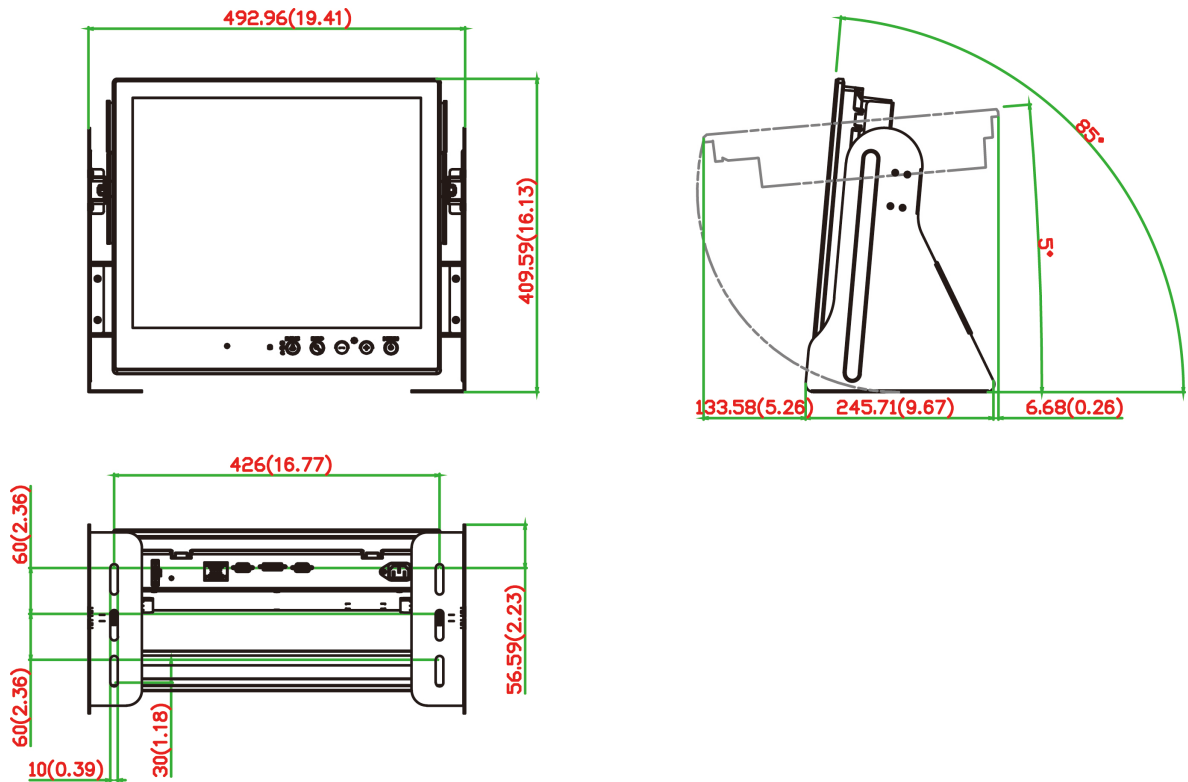

Place your MD-219 on a clean, flat, well-ventilated desktop. For better ventilation, leave some space between the MD-219 Series and other equipment. Do not place equipment or objects on top of the MD-219, as this might damage the display's internal components.

NOTE These desktop brackets are intended for temporary use when conducting lab tests, and are not intended to be used in permanent deployments.

Panel Mounting

The MD-219 Series comes with 14 optional clamp mounts that allow for installation onto a wall (where space has been cut out to accommodate the rest of the hardware) or into computing stations where a flush mount is desired. **The maximum thickness of the surface to which the display can be clamped is 11 mm.** For a secure mounting, all 14 clamps must be used. The clamp arms are fastened into slots on all four sides of the MD-219. Use the short M4 SUS (stainless) screws to fasten the clamp arms to the MD-219 mounting slots, as shown in the magnified inset in the diagram just below. Next, use the clamps to fasten the display to its mounting point; please note the torque values shown in the figure inset below.

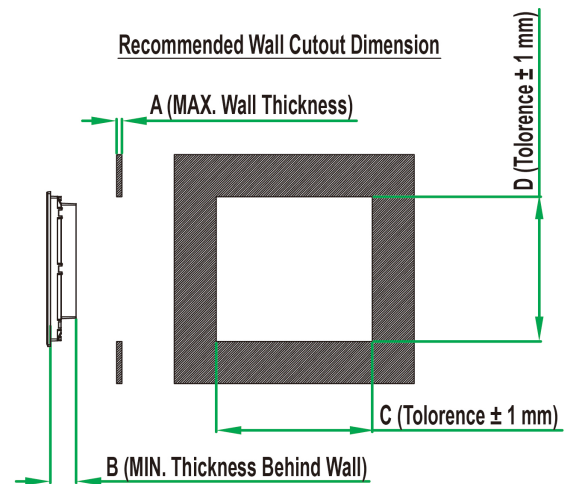

A	B	C	D	Mounting Kits (pcs)
12.0 mm	65.0 mm	411.0 mm	368.0 mm	10

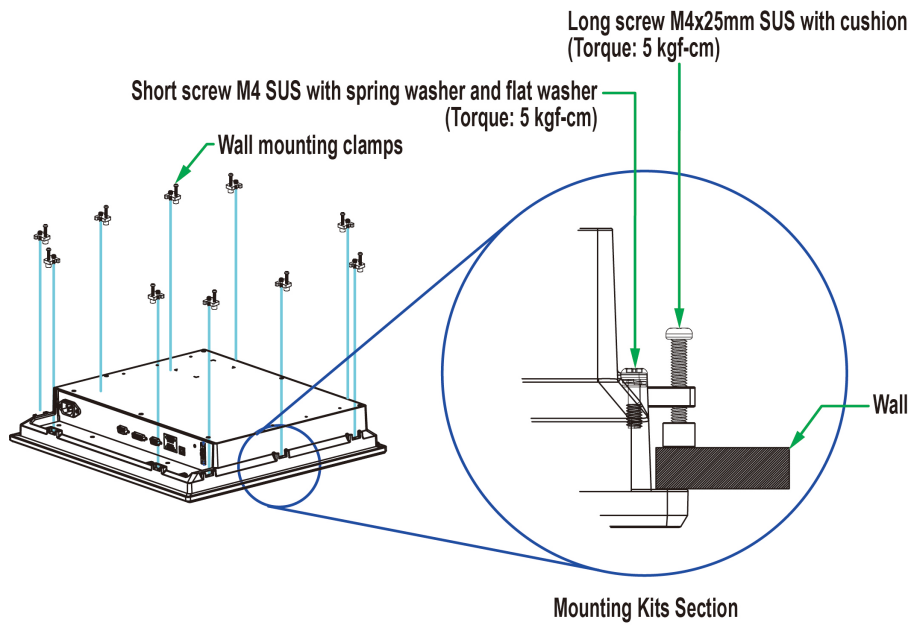

VESA Mounting

The MD-219 Series also comes with an optional VESA mounting kit. Six flat screws and four round screws are required to fasten the VESA mounting bracket. See the figure below for detailed screw specifications and torque values.

An additional four screws (not included in the kit) are required to mount the display on a VESA rack. For this purpose, use M6 screws with a length between 10 and 12 mm.

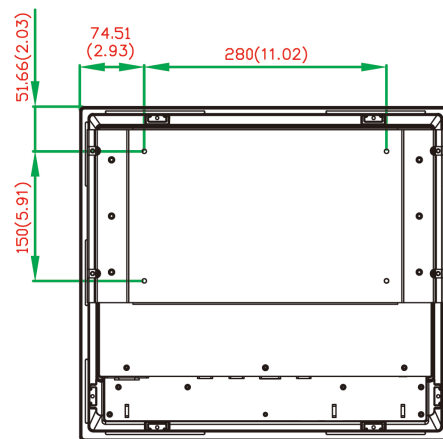
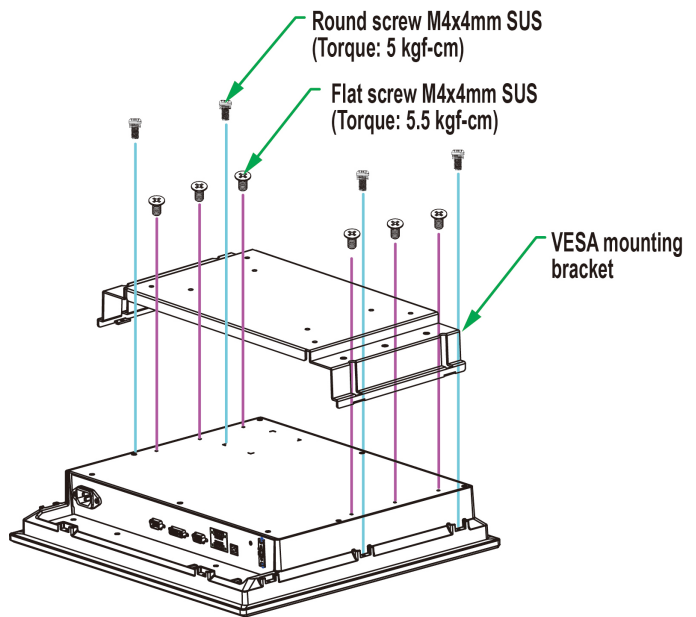

VESA Mounting Kit
4xM6 max. 10 mm deep mounting holes

Safety Precautions



ATTENTION

Safety First!

Be sure to disconnect the power cord before installing and/or wiring your MD-219 Series.

Wiring Caution!

Calculate the maximum possible current in each power wire and common wire. Observe all electrical codes dictating the maximum current allowable for each wire size. If the current goes above the maximum ratings, the wiring could overheat, causing serious damage to your equipment.

Temperature Caution!

Be careful when handling the unit. When the unit is plugged in, the internal components generate heat, and consequently the outer casing may feel hot to the touch.

We recommend taking the following precautions to minimize heat build-up within the display:

- Position the display within $\pm 40^\circ$ of the vertical.
- Install an external fan to increase airflow upwards through the display if (a) the display is not positioned within $\pm 40^\circ$ of the vertical, (b) the ambient temperature exceeds 25°C, or (c) the display is used in a location with minimal ventilation.

Important Safety Precaution

Even though the display is rated to operate within the IEC 60945 standard of -15 to 55°C for marine applications, it is best to ensure that the ambient temperature does not exceed 25°C. Doing so will increase the life of your display and minimize service costs.

Grounding the MD-219 Series

Be sure to ground the MD-219 Series before powering it on. Grounding and wire routing help limit the effects of noise due to electromagnetic interference (EMI). Run the ground connection from the ground screw to the grounding surface prior to connecting the power.



ATTENTION

This product is intended to be mounted to a well-grounded mounting surface, such as a metal panel.

Earth Ground: See the figure shown below for the location of the earth grounding connector. Connect the grounding wire to an appropriate grounded metal surface.

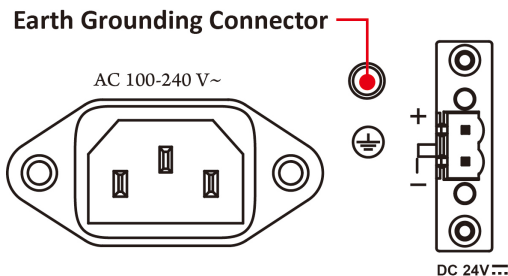

Powering on/off the MD-219 Series

To power on the MD-219 Series you may connect the **Terminal Block to Power Jack Converter** to the MD-219 Series DC terminal block (located on the bottom surface) and then connect a power adapter; or, alternatively, you may power the device with the AC power cord. Touch the **MENU** button (in the lower right corner of the display panel) for 1 second or use a UART command (MCC-0x9F-Power Down/Up Display) to turn on the display.

To power off the MD-219 Series, touch the **MENU** button for 4 seconds until the green LED light of the MENU button turns off, or use a UART command (MCC-0x9F-Power Down/Up Display) to turn off the display.

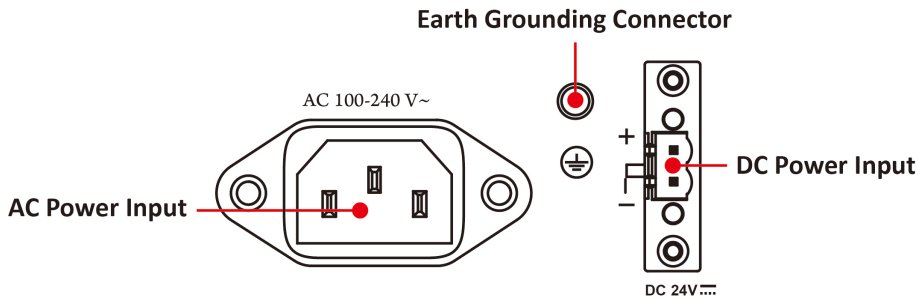

NOTE If the MD-219 is powered using a DC converter, an "OFF" message will appear when the INFO dialog displays the AC power status and vice versa. This will not affect the MD-219's operation.

SavvyTouch Display Control Buttons

The MD-219 Series comes with five SavvyTouch display control buttons located on the front surface. These intelligent controls will light up as your hand draws near the area of the screen where they are located.

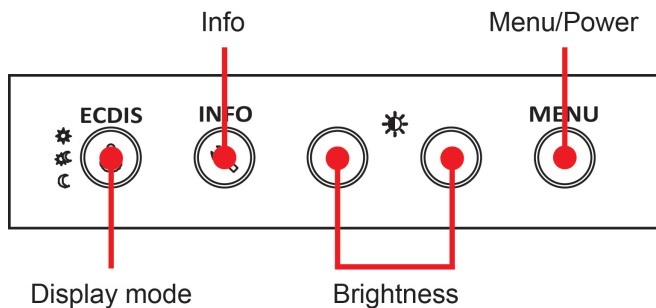

MENU

To configure the panel display settings, open the on-screen display (OSD) configuration panel by pressing the **MENU** button. The LCD panel will then display a configuration menu superimposed over the currently displayed image. The **MENU** button is for opening and closing the OSD, and brightness buttons "+/-" for navigating the OSD menus.

The **MENU** button operates like a power button in that it enables users to turn the display on and off. When you press the button for 1 second, the display will power on and indicate the status with a solid green color. To power off the MD-219, press and hold the **MENU** button for 4 seconds to turn the display and MENU button LED to OFF. On the OSD MAIN MENU page, use the same action to confirm or exit.

Brightness

Two brightness buttons are available for brightness control. Press the + button to increase the brightness of the panel; press the – button to decrease the brightness of the panel. On the OSD MAIN MENU page, the + and - buttons are used to increment and decrement values, and to move up and down between options.

INFO

The **INFO** button indicates the display status for power components, including AC and DC. “ON” indicates that the display is working well. An OFF message will be shown when the AC or DC power is not working.

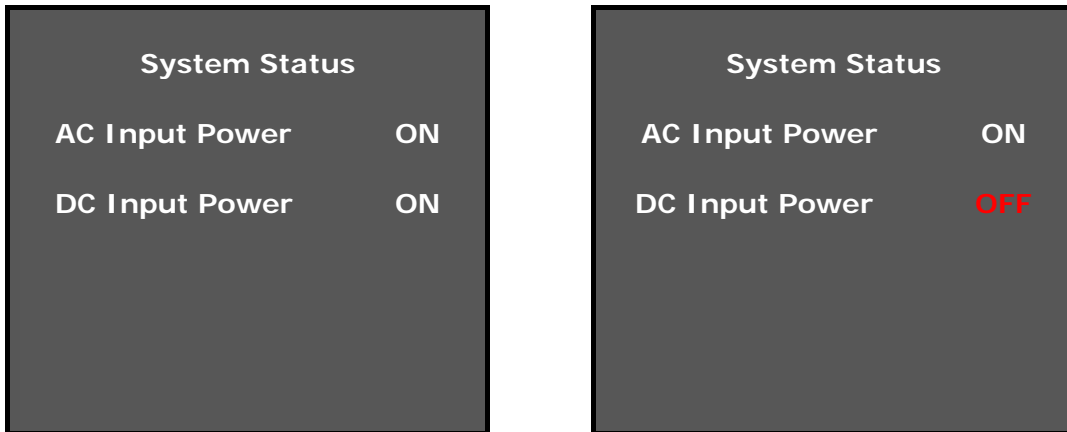

NOTE If the MD-219 is powered using a DC converter, an “OFF” message will appear when the INFO dialog displays the AC power status and vice versa. This will not affect the MD-219’s operation.

ECDIS

The ECDIS button is specially designed to support ECDIS for maritime applications. Touch the button to switch between the three different brightness modes (DAY, DUSK, and Night).

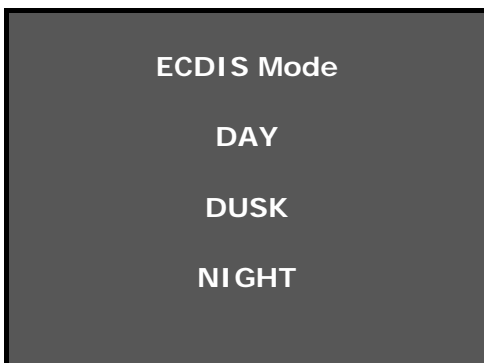

NOTE Pressing the ECDIS button will override the display’s current brightness setting.

Connecting Data Transmission Cables

Connecting the MD-219 to a Computer

Use a serial cable to connect your computer to the display's serial port. The serial port uses a male DB9 connector and terminal block. It can be configured by a UART command or OSD control. **Only one of the three interfaces (RS-232/422/485) can be used at the same time.** The pin assignments are shown in the following diagrams:

DB9 Male Port

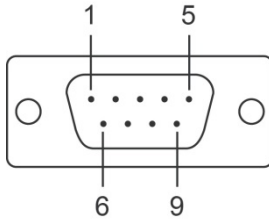

RS-232 (DB9 Male) Pinouts

Pin	RS-232
1	DCD
2	RxD
3	TxD
4	DTR
5	GND
6	DSR
7	RTS
8	CTS

Terminal Block Port

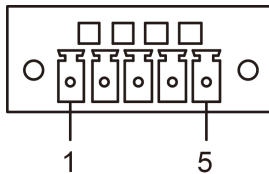

RS-422/485 (Terminal Block) Pinouts

Pin	RS-422	RS-485 (2-wire)
1	RxDB(+)	TDp(+)
2	RxDA(-)	TDn(-)
3	TxDB(+)	RDp(+)
4	TxDA(-)	RDn(-)
5	GND	GND

Configuring the RS-232/422/485 Serial Ports

For configuring the RS-232/422/485 serial port, please see **Appendix B: On-Screen Display (OSD) Controls** and **Appendix C: Display UART Commands**.

Enabling the Touch Screen Interface (Z models only)

The MD-219Z model comes with a USB port on its bottom panel. This USB port is used to connect the touch screen interface to a computer's peripheral device manager. To enable the panel's touch-screen feature, use a type A male to type B male USB cable to link the port to a peripheral device input on a PC, laptop, or embedded computer.

Microsoft® Windows® 7 and above come by default with factory installed Windows HID drivers that fully support multi-touch, and consequently, for these operating systems you do not need to install a driver that supports the multi-touch function. Microsoft® Windows® XP and older do not support touch technology, so you must install a driver to enable the touch function.

Drivers for the touch-screen interface are included on the MD-219 software CD. To install a driver, simply insert the Driver CD into the computer and select the operating system.

Once the driver is installed you can start using the MD-219's touch-screen features.

Connecting Video Input Cables

The MD-219 comes with VGA and DVI-D inputs, allowing you to connect two computers or laptops. Pin assignments are shown below:

VGA Connector

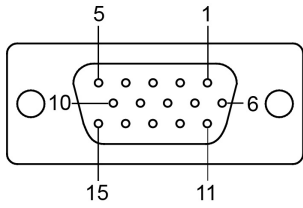

Pin No.	Signal Definition
1	Red
2	Green
3	Blue
4	NC
5	GND
6	GND
7	GND
8	GND
9	VCC
10	GND
11	NC
12	DDC Data
13	HSYNC
14	VSYNC
15	DDC Clock

DVI-D Connector

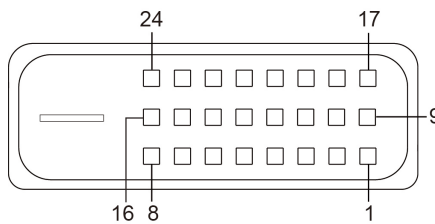

Pin No.	Signal Definition
1	T.M.D.S. Data2-
2	T.M.D.S. Data2+
3	T.M.D.S. Data2/4 Shield
4	N/C
5	N/C
6	DDC Clock
7	DDC Data
8	Analog Vertical Sync
9	T.M.D.S. Data1-
10	T.M.D.S. Data1+
11	T.M.D.S. Data1/3 Shield
12	N/C

Pin No.	Signal Definition
13	N/C
14	+5V Power
15	Ground (return for +5V, HSync, and VSync)
16	Hot Plug Detect
17	T.M.D.S. Data0-
18	T.M.D.S. Data0+
19	T.M.D.S. Data0/5 Shield
20	N/C
21	N/C
22	T.M.D.S. Clock Shield
23	T.M.D.S. Clock+
24	T.M.D.S. Clock-

Connecting the Built-in Buzzer

The MD-219 comes with a built-in buzzer terminal block located on the bottom of the product. It is normally used to connect more buzzers.

Buzzer

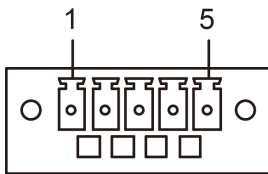

Buzzer Pinouts

Pin	Buzzer
1	GND
2	BUZ+
3	GND
4	-
5	GND

Touch Function

This chapter describes how to install the touch function drive and perform screen calibration.

The following topics are covered in this chapter:

- **Installing Touch Function Driver**
- **Performing Screen Calibration**

Installing Touch Function Driver

For MD-219Z multi-touch models, take the following steps to install the touch function driver. The driver can be found on the product DVD.

1. Open the eGalaTouch_7_Vista_XP_2K_5.11.0.9126 folder on the product DVD and then double click **setup.exe** in that folder to start the installation. Click **Next** to continue.

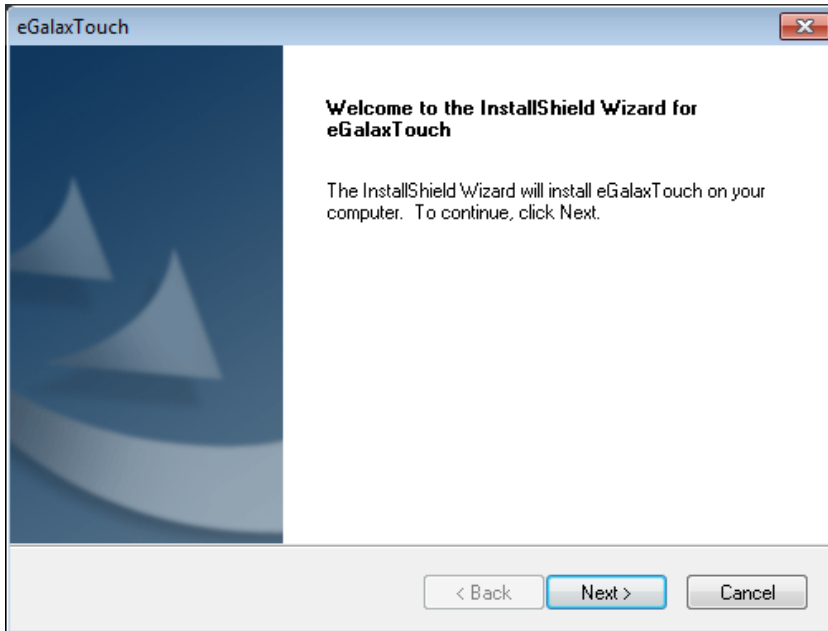

2. You do not need to check Install PS/2 interface drive. Click **Next** to continue.

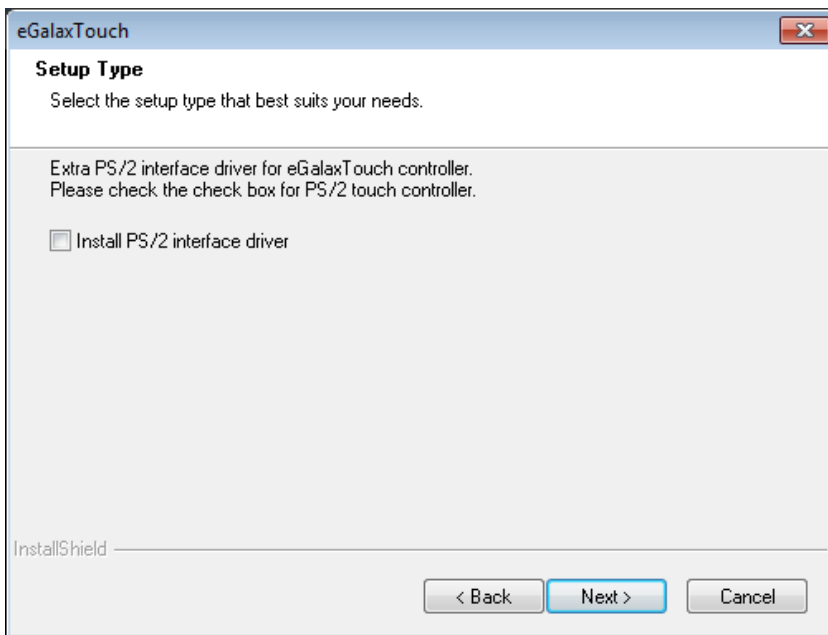

- 3. Check **Install RS232 interface drive**, and then click **Next** to continue.

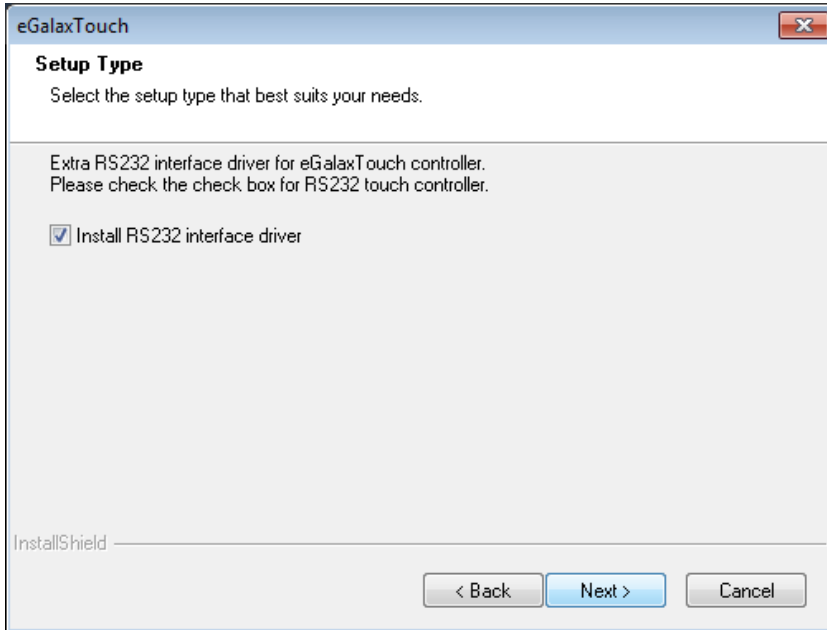

- 4. Select how the next touch screen calibration will be done and then click **Next** to continue.

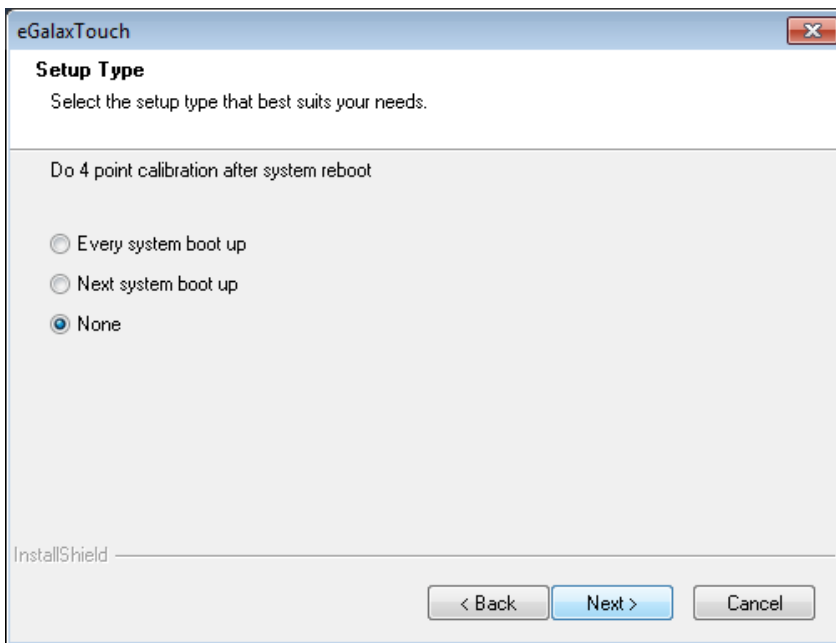

- 5. If you want to use the touch functiOn, make sure your touch controller's USB cable is plugged in to the MD-219. Click **OK** to continue.

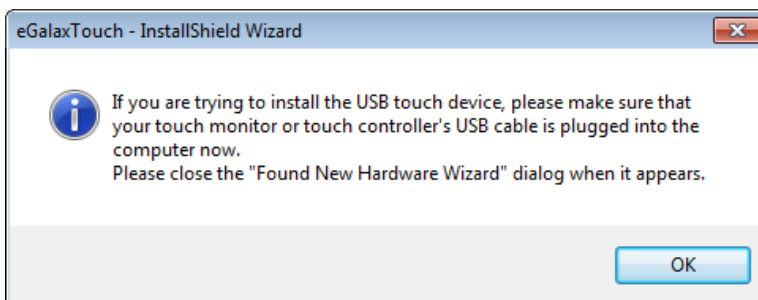

- 6. If needed, check the **Support Multit-Monitor System** checkbox, and then click **Next** to continue.

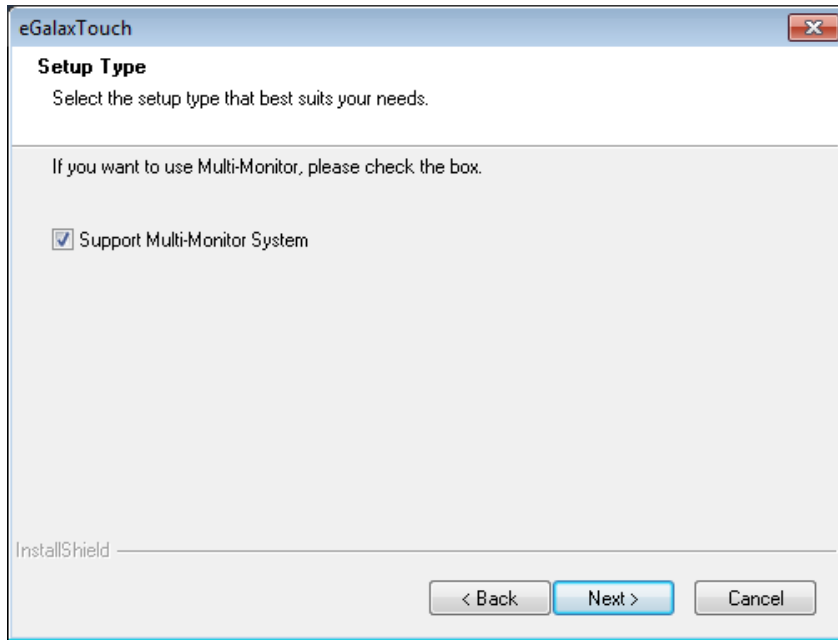

- 7. You may select the destination folder by clicking **Browse**, and then click **Next**.

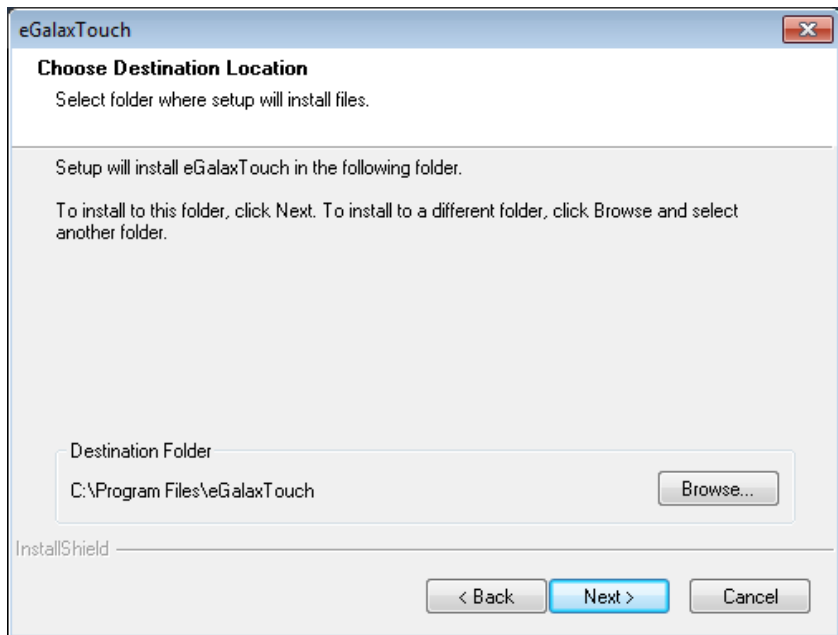

- 8. Click **Next** to continue.

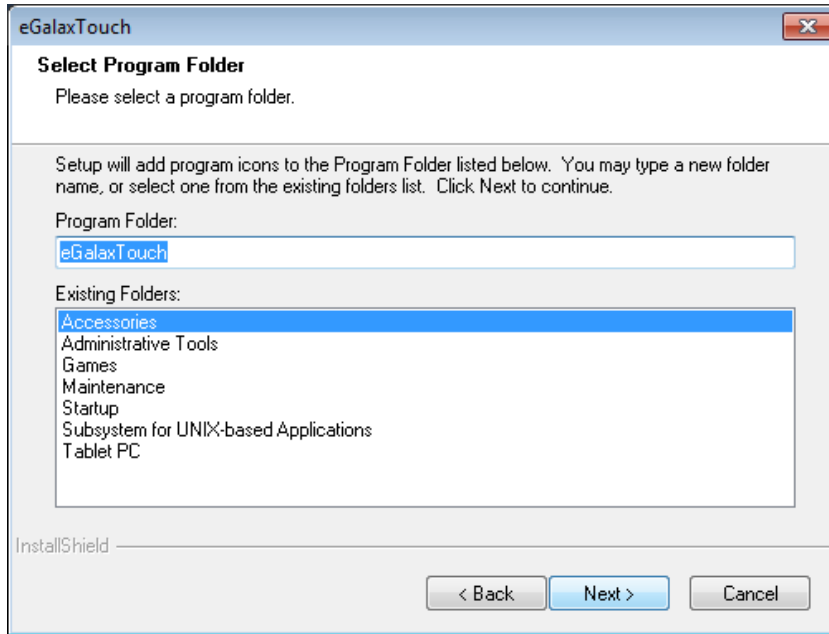

- 9. If needed, check the **Create a eGalaxTouch Utility shortcut on desktop** checkbox, and then click **Next** to continue.

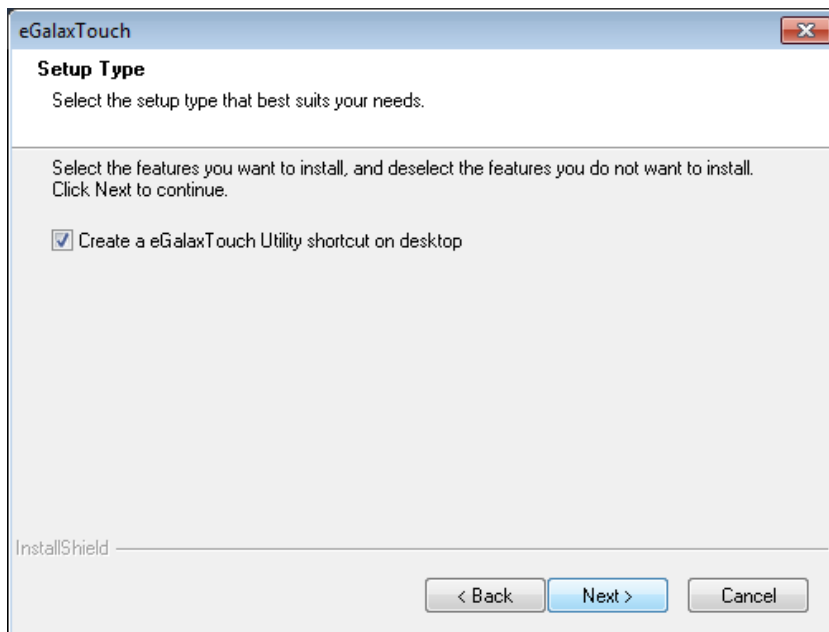

- Wait until the installation is finished.

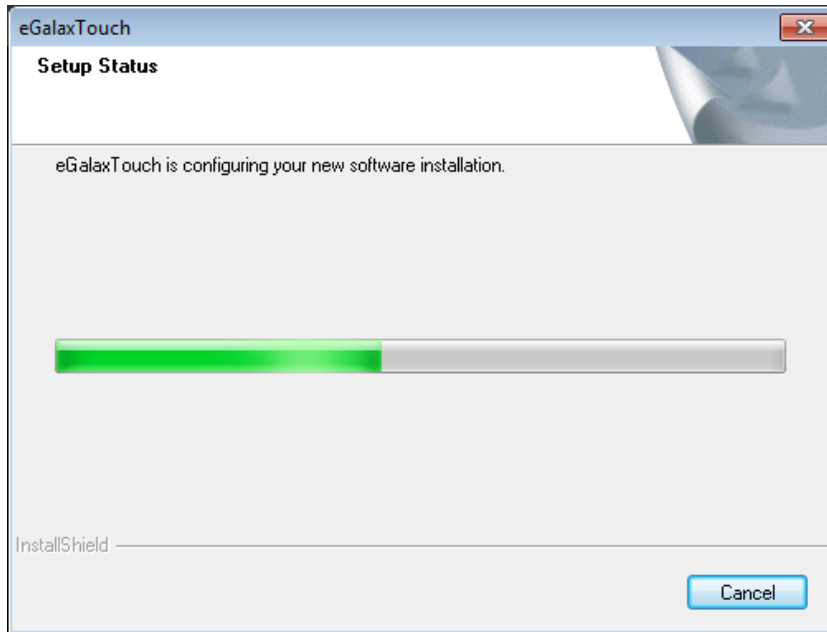

- When finished, click **Yes** to do a 4 point calibration for the touch function.

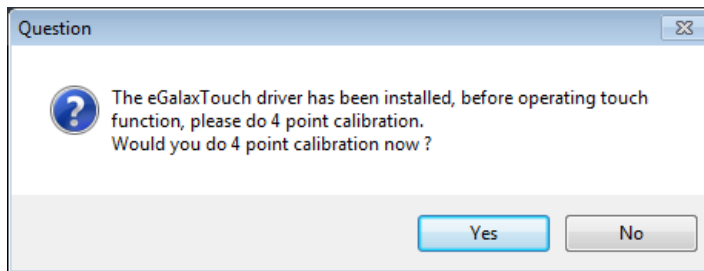

- Click the circle in the corner until it shows **OK**.

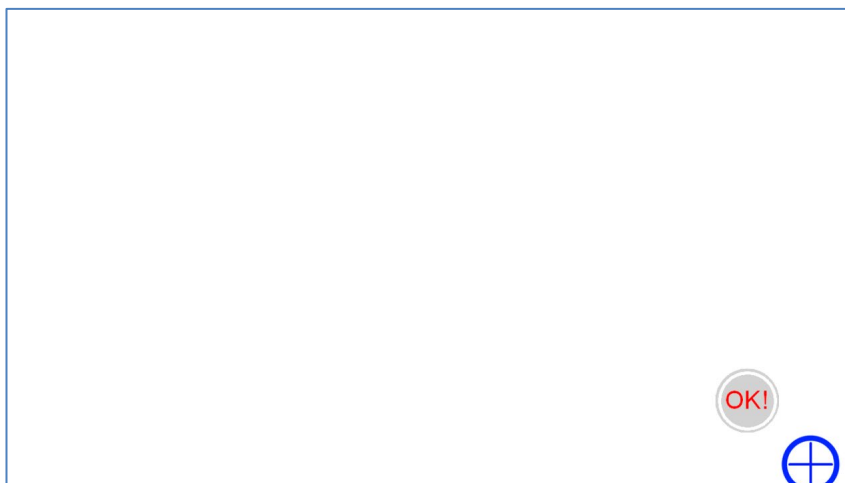

- Click **OK** to complete the installation process.

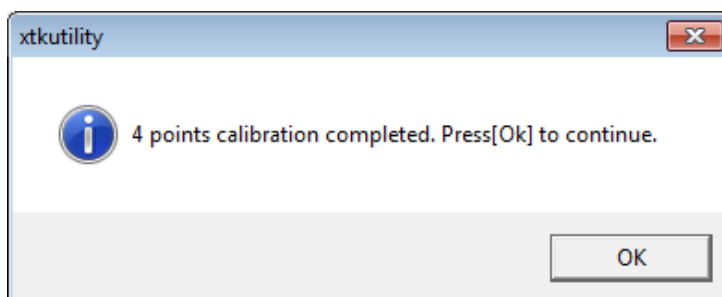

Performing Screen Calibration

You need to do a 4-point calibration whenever you change the display resolution so that the touch function can work normally. Follow these steps.

1. Run **eGalaxTouch** by double-clicking the icon on the desktop.



2. Select the **Tools** tab and click the **4 Points Calibration** button.

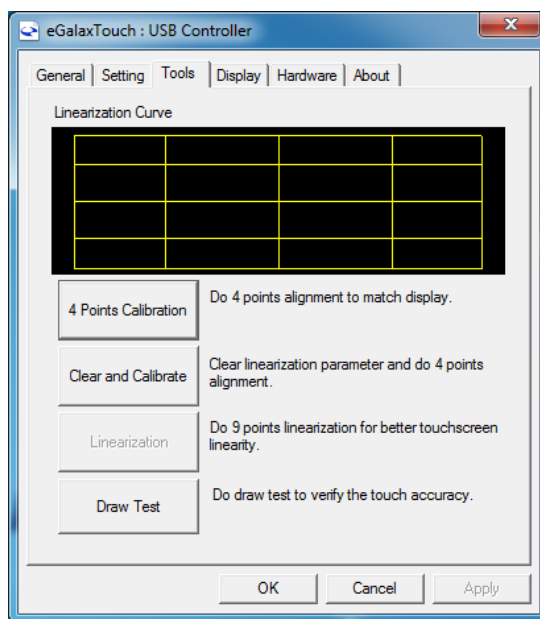

3. Click the circle in the corner until it shows **OK**.

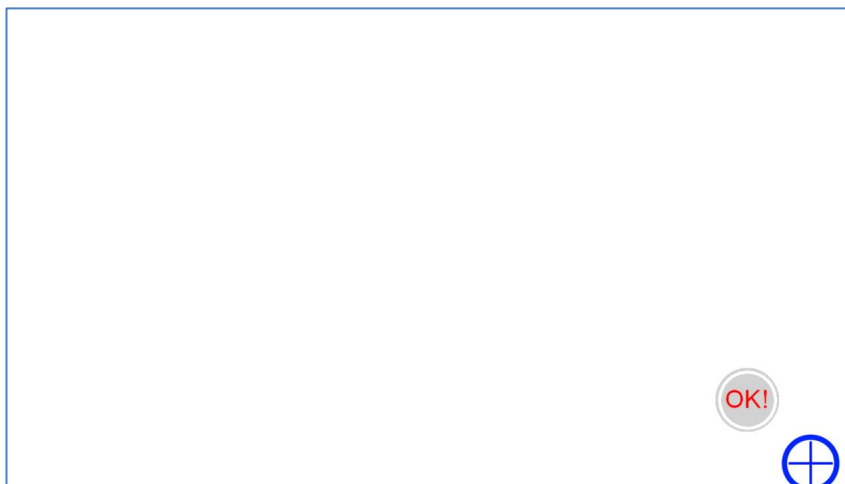

4. Click **OK** to complete the process.

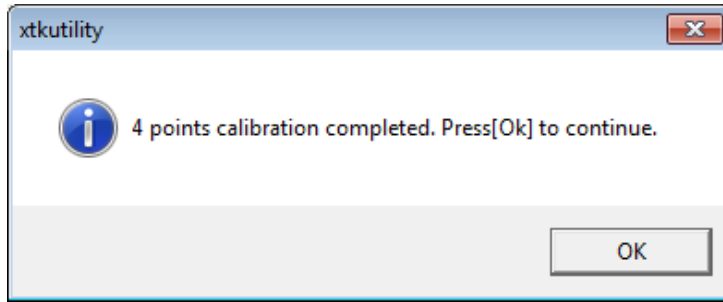

Display Control Interface

The MD-219 comes with a UART interface that gives system designers a convenient means of coding custom software controls for the display panel. This chapter describes the details of the UART control interface and the format of the available commands.

The following topics are covered in this chapter:

- ❑ **Connecting to the UART Control Interface**
- ❑ **UART Command Format**
 - Command Format Details
- ❑ **Downloading RGB Files**
 - VGA
 - DVI

Connecting to the UART Control Interface

The control interface of the MD-219 is accessed over the RS-232/422/485 serial port. A Telnet terminal (like Moxa's PComm terminal emulator, or PuTTY) should be used to communicate with the display.

When launching a terminal emulator you will need to configure the connection. Below, we show you how to configure an emulator using Moxa's PComm terminal emulator. The relevant connection settings are shown in step 2.

1. Select **Port Manager**, and then select **Open**.

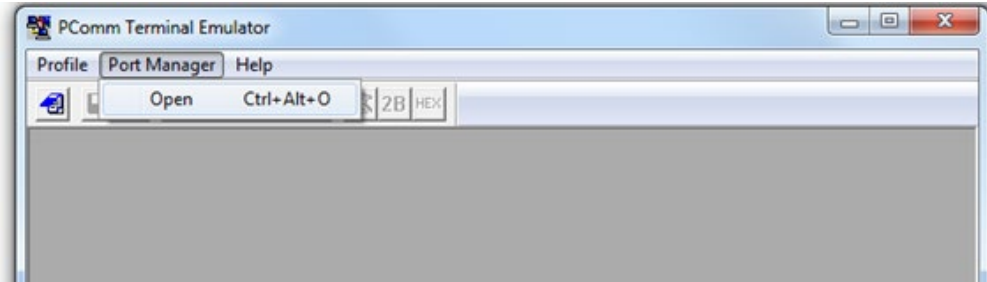

2. The connection settings are shown below. When finished, click **OK**.

Protocol: Serial
Serial Parameters:
 COM# (the actual number depends on the computer)
Baud rate: 9600
Data bits: 8
Parity: None
Stop bits: 1
RTS state: ON
DTR state: ON

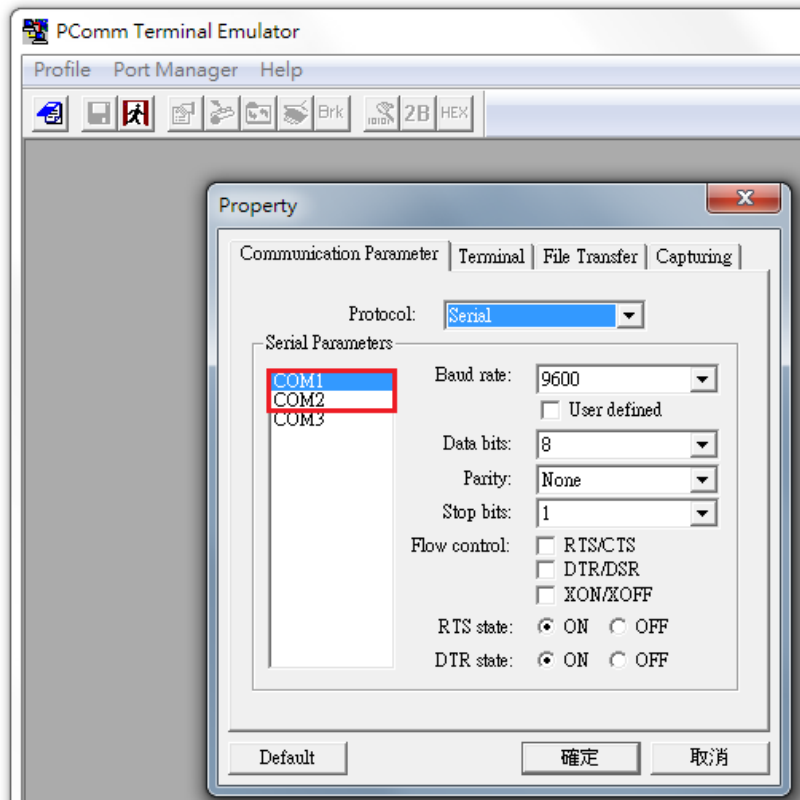

3. After successfully connecting, select the **Send pattern** tab.

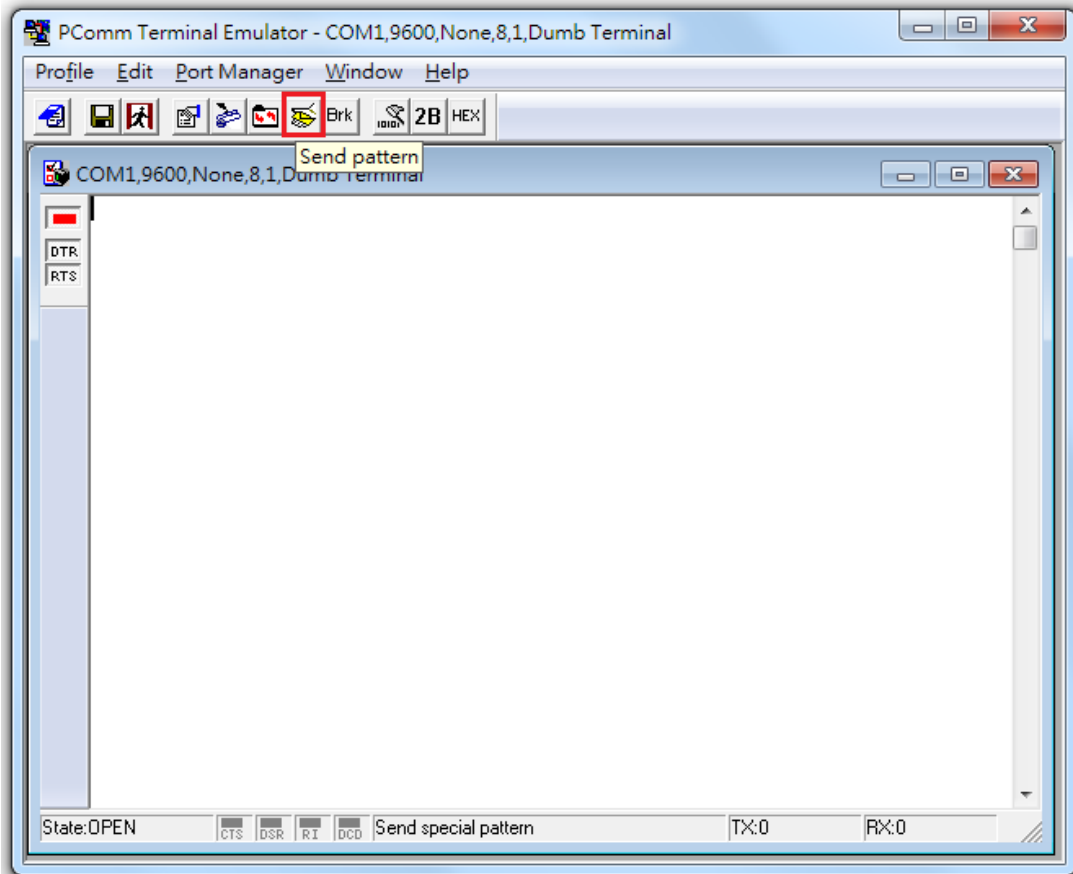

4. At this point, you may enter a command in the **HEX** field, and then click **Start Send** to send the command.

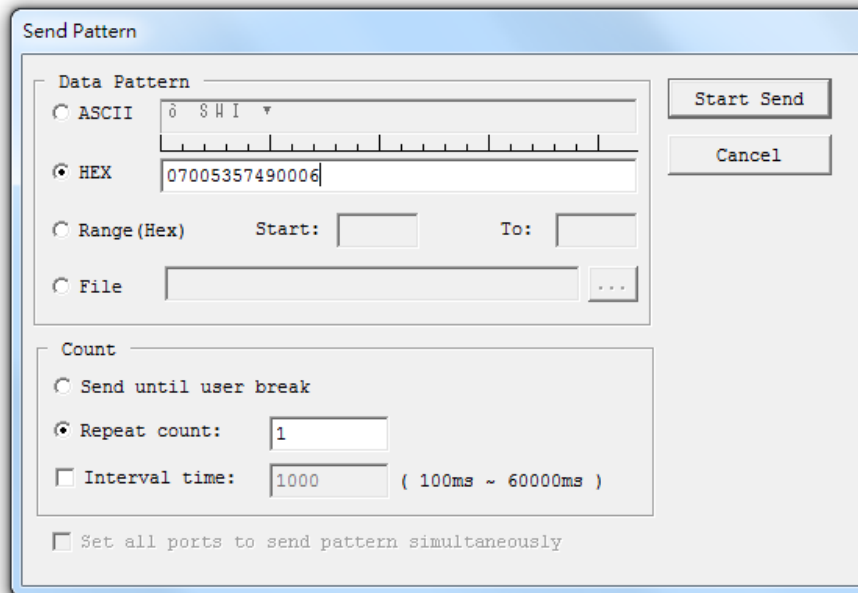

The following example queries the firmware version on the scalar board.

Example: Querying the scalar board's firmware version

0x07	0x00	0x53	0x57	0x49	0x00	0x06
------	------	------	------	------	------	------

For detailed command explanations, refer to the **Display UART Commands** section.

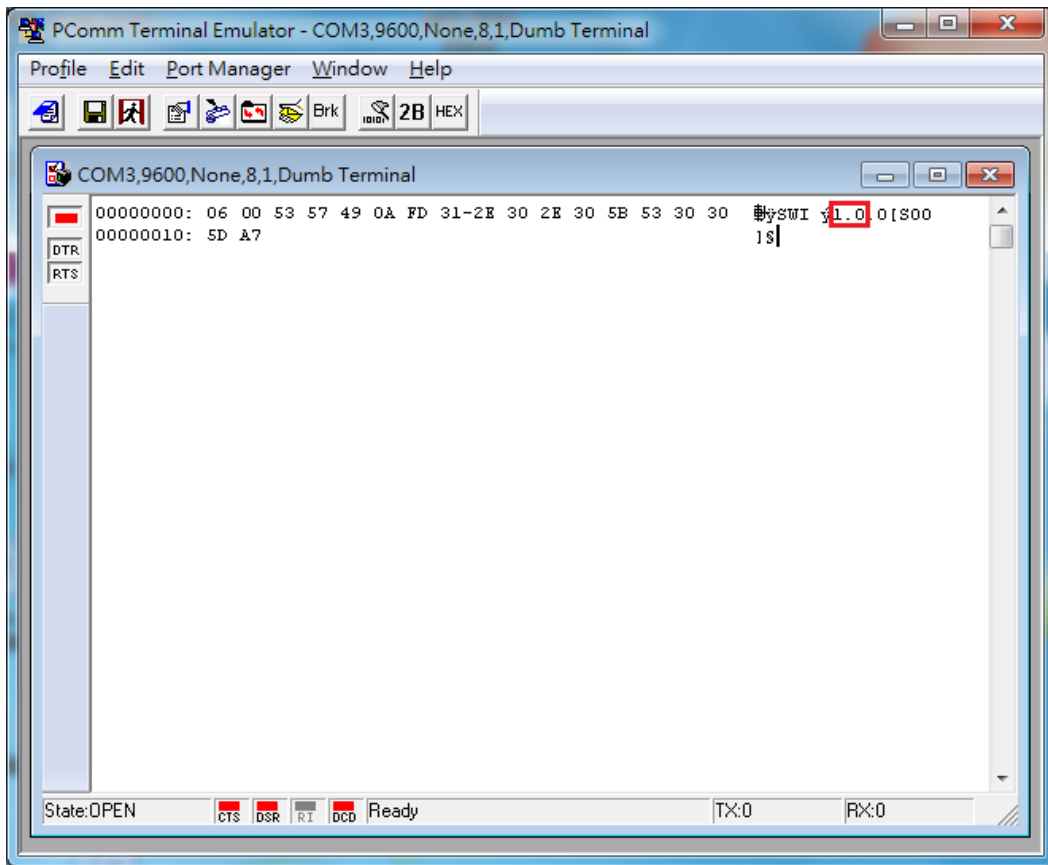

In the above screenshot, the scalar firmware version (1.0) is outlined in red.

UART Command Format

The message format is as follows:

Byte #	0	1	2,3,4	5	6	7 + (LEN-1)	7+LEN
	ATTN	ADDR	CMD	LEN	IHCHK	DATA	IDCHK

The minimum message size is 7 bytes, and the maximum size is 82 bytes.

Command Format Details

ATTN (Attention)

This byte is used to identify the start of a message; it can be one of three values:

ATTN	Description
0x07	Command (ASCII BELL) packet
0x06	Acknowledge (ASCII ACK) packet
0x15	Negative ACK (ASCII NAK) packet

A device sends a command with the 0x07 Attention Code. The unit will respond to the command with either an ACK if the command completed successfully, or a NAK if the command failed.

ADDR (Address)

This byte is used to specify the address where a command will be sent.

ADDR	Description
0xFF	Broadcast the command to all units
0x00 to 0x0F	Address of a specific unit, 0 to 15 (max 16 units)

CMD (Message Commands and Queries)

The command portion of the message will be one of the following values. For details, refer to the **Display UART Commands** section.

CMD 0	CMD 1	CMD 2	ASCII	Description
0x42	0x52	0x49	"BRI"	Brightness Minimum Value
0x42	0x52	0x4C	"BRL"	Set LED Brightness of Touch Keypad
0x42	0x52	0x4D	"BRM"	Brightness Maximum Value
0x42	0x52	0x54	"BRT"	User Brightness Control
0x42	0x52	0x55	"BRU"	Glass Display Control - Brilliance Button
0x42	0x5A	0x5A	"BZZ"	Buzzer Control
0x44	0x4C	0x4E	"DLN"	Download ECDIS RGB package
0x44	0x4C	0x3F	"DL?"	ECDIS RGB package Query
0x44	0x32	0x4E	"D2N"	Download ECDIS RGB package(Second)
0x44	0x32	0x3F	"D2?"	ECDIS RGB package Query(Second)
0x45	0x54	0x43	"ETC"	Elapsed Time Counter Query
0x47	0x4D	0x42	"GMB"	Glass Display Control - Minimum Brightness
0x50	0x4F	0x54	"POT"	Potentiometer Control
0x53	0x57	0x49	"SWI"	Scalar Firmware Version Query
0x53	0x57	0x4B	"SWK"	Touch Keypad Firmware Version Query
0x41	0x44	0x46	"ADF"	AC Input Power Detect Function
0x41	0x44	0x3F	"AD?"	Query AC Input Power Detect Function Status
0x44	0x44	0x46	"DDF"	DC Input Power Detect Function
0x44	0x44	0x3F	"DD?"	Query DC Input Power Detect Function Status
0x42	0x4C	0x49	"BLI"	Brightness Control
0x44	0x55	0x46	"DUF"	Disable UART Command Function
0x45	0x4D	0x53	"EMS"	ECDIS Mode Select
0x43	0x54	0x3F	"CT?"	Current Temperature Query
0x53	0x53	0x3F	"SS?"	System Status Query
0x4D	0x43	0x43	"MCC"	OSD Control Command

LEN (Data Length)

This byte defines the length of data in the message in bytes. The maximum value for this field is 74 bytes, and the minimum value is 0.

IHCHK (Inverse Header Checksum)

This is a simple 8-bit checksum of the first six bytes of the packet (bytes 0 to 5) after a bitwise inversion has been performed on them. This means the 8-bit sum (without carrying) of bytes 0, 1, 2, 3, 4, 5, and 6 is **0xFF**.

$$\text{IHCHK} = 0xFF - [\text{the sum of bits } 0, 1, 2, 3, 4, 5]$$

DATA (Data Field)

The data field must have a LEN larger than 0; some commands do not have any data, so this field is left blank.

IDCHK (Inverse Data Checksum)

This is a simple 8-bit checksum of the data field, message bytes 7 to 7+ (LEN-1) after a bit-wise inversion has been performed on each bit. This means that the IDCHK bit is equal to 0xFF, the sum of all data bits:

$$\text{IDCHK} = 0xFF - [\text{the sum of bits } 7 \text{ to } 7+[\text{LEN}-1]]$$

If the message carries no data, then this checksum is not transmitted.

Downloading RGB Files

This feature returns the ECDIS RGB file that is currently saved to the EEPROM; consequently, it is only available for type-approved ECDIS models.

VGA

Use the following commands for downloading RGB files from VGA input source.

Command	Description
DL?	Data: none (0 byte) ACK: Total packet numbers (1 byte)
DLN	Data: Appointed packet (1 byte) ACK: File content (30 bytes maximum, except for the last packet)

The command **DL?** will send a request to the micro controller and ask how many packets need to be downloaded. The reply from the micro controller should be used when using the command **DLN** to download the specific packets. Refer to the following section for detailed descriptions of the **DL?** and **DLN**.

Query the RGB File Size (in packets): DL? Command

	Byte 0	Byte 1	Byte 2	Byte 3	Byte 4	Byte 5	Byte 6
Hex	0x7	0xFF	0x44	0x4C	0x3F	0x0	0x2A
ASCII			D	L	?		

Download the RGB File: DLN Command

	Byte 0	Byte 1	Byte 2	Byte 3	Byte 4	Byte 5	Byte 6	Byte 7	Byte 8
Hex	0x7	0xFF	0x44	0x4C	0x4E	0x1	0x1A	appointed packet	0xAF
ASCII			D	L	N				

Here is sample command to read and return packet zero of the RGB file:

0x07	0xFF	0x44	0x4C	0x4E	0x01	0x1A	0x00	0xFF
------	------	------	------	------	------	------	------	------

This is the ACK packet that is returned, with data packet 0 located in the **Data** section.

0x06	0xFF	0x44	0x4C	0x4E	0x20	0xFC	0x00	-	Data	IDCHK
------	------	------	------	------	------	------	------	---	------	-------

This result shows the actual value of RGB file package 0. The results could be different for different machines.

DVI

Use the following commands for downloading RGB files from the DVI input source:

Command	Description
D2?	Data: none (0 byte) ACK: Total packet numbers (1 byte)
D2N	Data: Appointed packet (1 byte) ACK: File content (30 bytes maximum, except for the last packet)

The command **D2?** will send a request to the micro controller and ask how many packets need to be downloaded. The reply from the micro controller should be used when using the command **D2N** to download the specific packets. Refer to the following section for a detailed description of **D2?** and **D2N**.

Query the RGB File Size (in packets): D2? Command

	Byte 0	Byte 1	Byte 2	Byte 3	Byte 4	Byte 5	Byte 6
Hex	0x7	0xFF	0x44	0x4C	0x3F	0x0	0x2A
ASCII			D	2	?		

Download the RGB File: D2N Command

	Byte 0	Byte 1	Byte 2	Byte 3	Byte 4	Byte 5	Byte 6	Byte 7	Byte 8
Hex	0x7	0xFF	0x44	0x4C	0x4E	0x1	0x1A	Appointed packet	0xAF
ASCII			D	2	N				

This is a sample command for reading and returning packet 0 of the RGB file:

0x07	0xFF	0x44	0x4C	0x4E	0x01	0x1A	0x00	0xFF
------	------	------	------	------	------	------	------	------

This is the ACK packet that is returned, with data packet 0 located in the **Data** section.

0x06	0xFF	0x44	0x4C	0x4E	0x20	0xFC	0x00	-	Data	IDCHK
------	------	------	------	------	------	------	------	---	------	-------

This result shows the actual value of RGB file package 0. The results could be different for different machines.

A

Regulatory Approval Statement



This device complies with part 15 of the FCC Rules. Operation is subject to the following two conditions: (1) This device may not cause harmful interference, and (2) this device must accept any interference received, including interference that may cause undesired operation.

Class A: FCC Warning! This equipment has been tested and found to comply with the limits for a Class A digital device, pursuant to part 15 of the FCC Rules. These limits are designed to provide reasonable protection against harmful interference when the equipment is operated in a commercial environment. This equipment generates, uses, and can radiate radio frequency energy and, if not installed and used in accordance with the instruction manual, may cause harmful interference to radio communications. Operation of this equipment in a residential area is likely to cause harmful interference in which case the user will be required to correct the interference at his/her own expense.



European Community

Warning:

This is a class A product. In a domestic environment this product may cause radio interference in which case the user may be required to take adequate measures.

On-Screen Display (OSD) Controls

This chapter discusses how to navigate the On-screen Display (OSD) and how to use the menus to adjust the panel's image properties.

The following topics are covered in this appendix:

▣ Opening the Configuration Screen

▣ OSD Menu Map and Items Explained

- Source – Auto Source
- Image Setting – Auto Setup
- Image Setting – Display
- Color Mode – Color Temperature
- Color Mode – Color Temperature – User
- Management – Communication
- OSD Misc – OSD position
- OSD Misc – Language
- OSD Misc – Preset Save
- OSD Misc – OSD Lock Mode
- Service
- Service – Test Pattern

Opening the Configuration Screen

To configure the panel display settings, open the on-screen display (OSD) configuration panel by pressing the **MENU** button. The LCD panel will then display a configuration menu superimposed over the currently displayed image. The OSD controls consist of five LEDs (MENU, BR+/-, Info, and ECDIS).

OSD Menu Map and Items Explained

Source – Auto Source



Select signal source input between different inputs (DVI or VGA) as well as enable or disable the Auto Source functionality.

- VGA: Set signal source to "VGA"
- DVI: Set signal source to "DVI"
- Auto Source: When "Auto Source" value is "Yes", signal is automatically searched for and selected. The default value is Yes.

Image Setting – Auto Setup

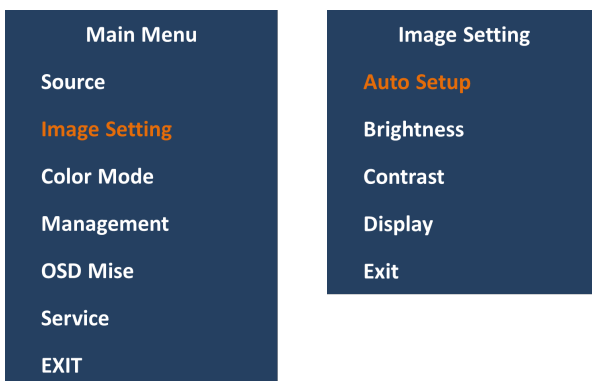

Configure various visual preferences.

- Auto Setup: Automatically fit / reset the current signal and adjust the image.
- Available only the signal of VGA
- Brightness: Increase/decrease the brightness of display. Value adjustable from 0 to 255. The default value is 160.
- Contrast: Increase/decrease the contrast of display. Value adjustable from 0 to 100. The default value is 0.

Image Setting – Display

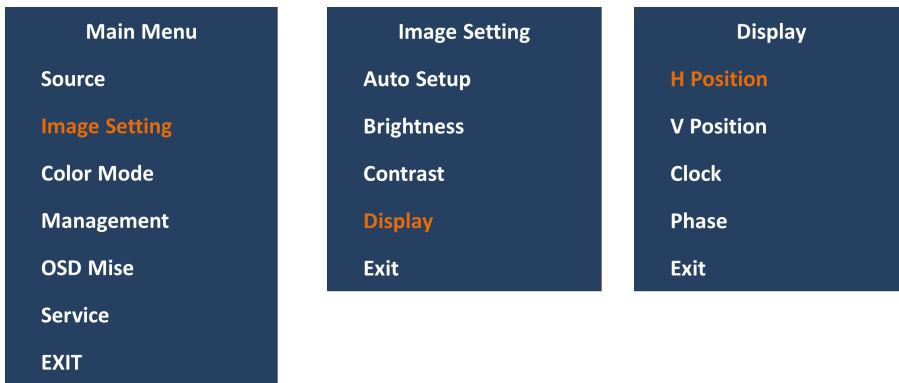

Adjust “VGA” signal Horizontally (left/right) and Vertically (up/down) and Clock and Phase.

- H Position: Move image horizontally (left/right).
- V Position: Move image vertically (up/down).
- Clock: Adjust the horizontal frequency (clock) of the analog signal.
- Phase: Fine tune the data sampling position (impacts on image quality).

Color Mode – Color Temperature

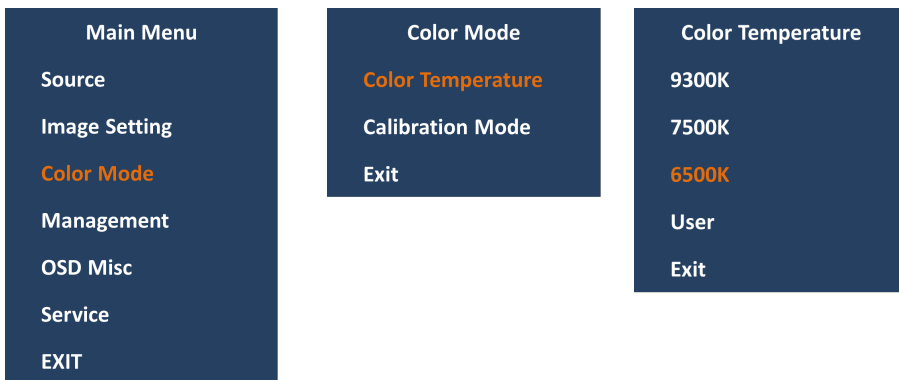

Adjust the color temperature (Kelvin degrees) of the image.

- 9300K = Cool, a bluish white.
- 7500K = Neutral, a white close to natural light.
- 6500K = Warm, a reddish white.

Color Mode – Color Temperature – User

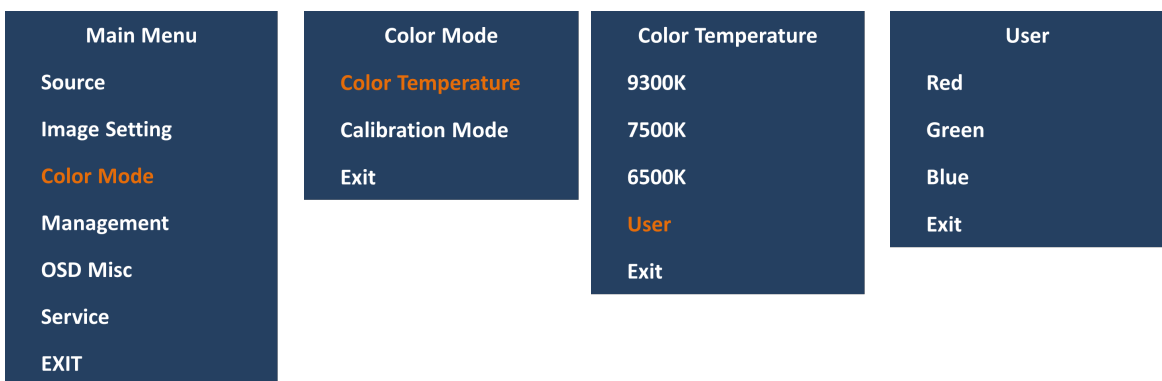

Adjust individual value of Red, Green and Blue color gains.
Value adjustable from 0 to 100. The default value is 100.

Management – Communication



Set up serial communication mode for remote control and/or accessing internal information about the unit, including brightness, firmware version, and other values.

- RS232 = Sets to use standard RS-232 protocol through DB9 connector
- RS422 = Sets to use standard RS-422 protocol through terminal block connector
- RS4852W = Sets to use RS-485 protocol (Half duplex) through terminal block connector
- Address RS = Set the unit address (0x00 to 0x0F).

OSD Misc – OSD position



Adjust the visual appearance of the On Screen Display (OSD) menu.

- OSD H.Position = Adjust OSD menu horizontally (left/right), values from 0 to 100.
- OSD V.Position = Adjust OSD menu vertically (up/down), values from 0 to 100.
- The default value for both functions is 100.

OSD Misc – Language

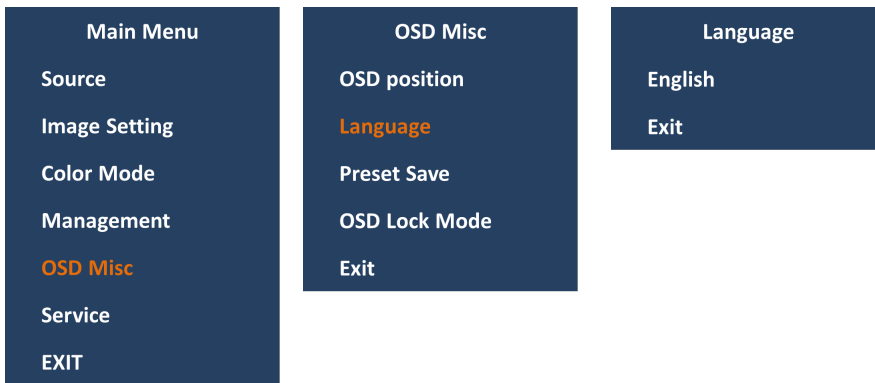

OSD language to be used for all text and warnings.

- English = Display OSD in English.
- There are only English supported now.

OSD Misc – Preset Save

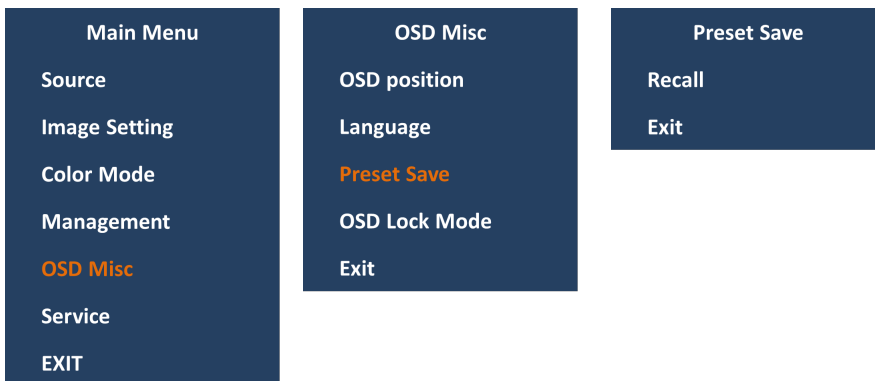

Allows it to work with Memory Presets (Recall) for OSD menu settings.

- Recall = Reset to default setting and value. Will override and restore all previous modified settings.

OSD Misc – OSD Lock Mode

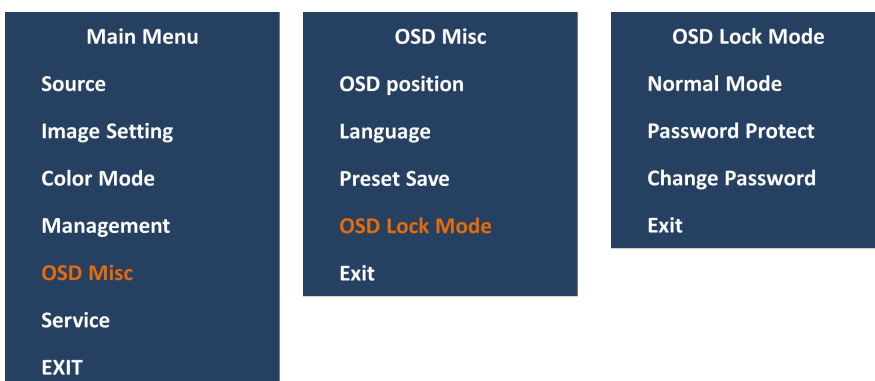

Prevent accidental user intervention, can set the behavior of how the OSD menu is accessible by the user.

- Normal Mode = Default accessible pop-up by touching the "MENU" button.
- Password Protect = Ask for key code first (321).
- Change Password = Change password value. Using BR+/- and MENU button change and confirm password. Default password is "321".

Service

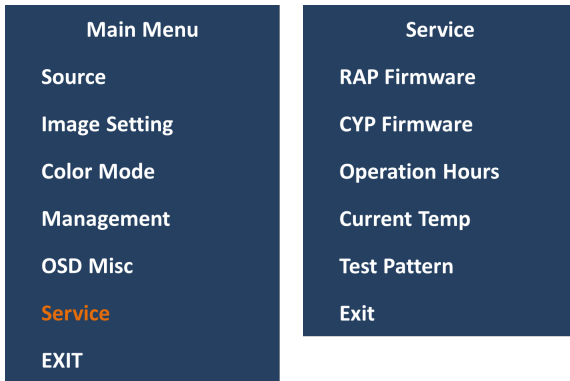

Show various technical and unit related information, including Firmware versions, Elapsed Time, Internal Temperature and activation for the internal Test Pattern image useful for troubleshooting.

- RAP Firmware Rev = Displays the scalar firmware version. Example: "Ver. 1.0.0"
- CYP Firmware Rev = Displays the touch keypad firmware version. Example: "Ver. 1.0.0"
- Operation Hours = Shows the time elapsed. Example: "0 Year 1 Hour 30 Minute"
- Current Temperature = Shows the internal temperature measured by on chip sensor. Example: "35 C", in Celcius Degrees. "53 F", in Fahrenheit Degrees.

Service – Test Pattern



Show the internal test pattern with color boxes for White, Black, Red, Green, Blue and to check for deviations in the TFT panel/display controller behavior. It is independent of any current resolution or specifications found in the signal inputs. The test pattern is generated internally in the display controller and is sent 1:1 directly to the TFT panel

Display UART Commands

In this appendix, we define the serial data format and serial communication protocol that engineers can use to program the MD-219's display. In particular, we explain how to use the display's UART commands.

The following topics are covered in this appendix:

▣ OSD Control Command

- BRI (Brightness Minimum Value)
- BRL (Set LED Brightness of Touch Keypad)
- BRM (Brightness Maximum Value)
- BRT (User Brightness Control)
- BRU (Glass Display Control-Brightness Button)
- BZZ (Buzzer Control)
- DLN (Download ECDIS RGB File)
- DL? (ECDIS RGB Package Query)
- D2N (Download ECDIS RGB File (Second))
- D2? (ECDIS RGB Package Query (Second))
- ETC (Elapsed Time Counter Query)
- GMB (Glass Display Control - Minimum Brightness)
- POT (Potentiometer Control)
- SWI (Scalar Firmware Version Query)
- SWK (Touch Keypad Firmware Version Query)
- ADF (AC Input Power Detect Function)
- AD? (Query AC Input Power Detect Function Status)
- DDF (DC Input Power Detect Function)
- DD? (Query DC Input Power Detect Function Status)
- BLI (Brightness Control)
- DUF (Disable UART Command Function)
- EMS (ECDIS Mode Select)
- CT? (Current Temperature Query)
- SS? (System Status Query)
- MCC (OSD Control Command)

OSD Control Command

In this section, we describe the OSD control commands that can be used to configure the display. See the following descriptions.

BRI (Brightness Minimum Value)

This command sets the brightness minimum value. The range is from 0x00 to 0x31 (0% - 100%). LEN=one data byte.

Examples:

Command to set 30% brightness.

0x07	0xFF	0x42	0x52	0x49	0x01	0x1B	0x10	0xEF
------	------	------	------	------	------	------	------	------

BRL (Set LED Brightness of Touch Keypad)

This command sets the LED brightness value of the touch keypad. The range is from 0x00 to 0x31 (0% - 100%). The default brightness value of the touch keypad will be changed in the ratio of the panel backlight brightness. You can send **?toquery** the current value of the led brightness value. LEN=one data byte.

Examples:

Command to set 100% Brightness.

0x07	0xFF	0x42	0x52	0x4C	0x01	0x18	0x31	0xCE
------	------	------	------	------	------	------	------	------

BRM (Brightness Maximum Value)

This command sets the brightness maximum value. The range is from 0x00 to 0xFF (0% - 100%). LEN=one data byte.

Examples:

Command to set 88% Brightness.

0x07	0xFF	0x42	0x52	0x4D	0x01	0x17	0xE0	0x1F
------	------	------	------	------	------	------	------	------

BRT (User Brightness Control)

This command sets the maximum brightness of the panel. The range is from 0x00 to 0xFF (0% - 100%). The default value is **0xFF**.

Note that whenever the MD-219 has been restarted, the BRT value will be reset to 100%. If the BRT value has been changed (i.e., the BRT value does not equal 0xFF), the ECDIS function will not be supported and the ECDIS function keys will be disabled and turned off.

If the data and data checksum are incorrect, the reply data field is the current BRT value. LEN=one data byte.

Examples:

Command to set 40% Brightness.

0x07	0xFF	0x42	0x52	0x54	0x01	0x10	0x66	0x99
------	------	------	------	------	------	------	------	------

ACK set to 40% Brightness

0x06	0xFF	0x42	0x52	0x54	0x01	0x11	0x66	0x99
------	------	------	------	------	------	------	------	------

NAK default Brightness 100%

0x15	0xFF	0x42	0x52	0x54	0x01	0x02	0xFF	0x00
------	------	------	------	------	------	------	------	------

BRU (Glass Display Control-Brightness Button)

This command sets the LED brightness value of the touch keypad. The range is from 0x00 to 0xFF (0% - 100%). The default brightness value of the touch keypad will be changed in the ratio of the panel backlight brightness.

You can send a ? to query the current LED brightness value. LEN=one data byte.

Examples:

Command to set 100% Brightness.

0x07	0xFF	0x42	0x52	0x55	0x01	0x0F	0xFF	0x00
------	------	------	------	------	------	------	------	------

BZZ (Buzzer Control)

The default value for the buzzer is **OFF**. Users can send this command to turn the buzzer on/off.

If the data and data checksum are incorrect, the reply data field is the current buzzer status. LEN=one byte.

0x00	Turn the buzzer OFF
0xFF	Turn the buzzer ON
0x3F	Query the current status

Examples:

Turn the buzzer **ON**.

0x07	0xFF	0x42	0x5A	0x5A	0x01	0x02	0xFF	0x00
------	------	------	------	------	------	------	------	------

ACK

0x06	0xFF	0x42	0x5A	0x5A	0x01	0x03	0xFF	0x00
------	------	------	------	------	------	------	------	------

Query the current status.

0x07	0xFF	0x42	0x5A	0x5A	0x01	0x02	0x3F	0xC0
------	------	------	------	------	------	------	------	------

ACK the current status of the buzzer is ON

0x06	0xFF	0x42	0x5A	0x5A	0x01	0x03	0xFF	0x00
------	------	------	------	------	------	------	------	------

DLN (Download ECDIS RGB File)

Before sending this command, use **DL?** to determine how many available packets are in each ECDIS table. This command cannot be used if the MD-219 has not been calibrated. Every packet has a head (Byte 7 and Byte 8); Byte 7 is the packet number and Byte 8 is the ASCII code for "-"; the remaining bytes are the data. If the packet is full the data is in Byte 9 to Byte 38. LEN=one data byte.

Data length is 32. The first byte is package num., the second byte is "-" and the other 30 bytes are data.

Examples:

Command to read packet 0.

0x07	0xFF	0x44	0x4C	0x4E	0x01	0x1A	0x00	0xFF		
------	------	------	------	------	------	------	------	------	--	--

ACK packet 0 of the first RGB file

0x06	0xFF	0x44	0x4C	0x4E	0x20	0xFC	0x00	0x2D	Data	IDCHK
------	------	------	------	------	------	------	------	------	------	-------

DL? (ECDIS RGB Package Query)

Use **DL?** to determine how many available packets are in each ECDIS table. This command cannot be used if the MD-219 has not been calibrated. Total package num = Size of ECDIS RGB file/30 bytes per package.

Examples:

Send **DL?** command to query total package num. of the first RGB file.

0x07	0xFF	0x44	0x4C	0x3F	0x00	0x2A
------	------	------	------	------	------	------

ACK 255 packages

0x06	0xFF	0x44	0x4C	0x3F	0x01	0x2A	0xFF	0x00
------	------	------	------	------	------	------	------	------

D2N (Download ECDIS RGB File (Second))

Before sending this command, use **DL?** to determine how many available packets are in each ECDIS table. This command cannot be used if the MD-219 has not been calibrated. Every packet has a head (Byte 7 and Byte 8); Byte 7 is this packet number and Byte 8 is the ASCII code for "-"; the remaining bytes are the data. If the packet is full the data is in Byte 9 to Byte 38. LEN=one data byte.

Data length is 32. The first byte is package num., the second byte is "-" and the other 30 bytes are data.

Examples:

Command to read packet 0.

0x07	0xFF	0x44	0x32	0x4E	0x01	0x34	0x00	0xFF
------	------	------	------	------	------	------	------	------

ACK packet 0 of the first RGB file

0x06	0xFF	0x44	0x32	0x4E	0x20	0x16	0x00	0x2D	Data	IDCHK
------	------	------	------	------	------	------	------	------	------	-------

D2? (ECDIS RGB Package Query (Second))

Every packet has 32 bytes of data; the first byte is the packet number, the second byte is "-" and the remaining 30 bytes are data

Examples:

Send a **D2?** command to query the total number of packets of the first RGB file.

0x07	0xFF	0x44	0x32	0x3F	0x00	0x44
------	------	------	------	------	------	------

ACK 255 packets.

0x06	0xFF	0x44	0x32	0x3F	0x01	0x44	0xFF	0x00
------	------	------	------	------	------	------	------	------

ETC (Elapsed Time Counter Query)

This command queries the elapsed time that the unit has been operating. No data will be sent with this command. The unit will reply to this command with an ACK attention code. The DATA field will be set to a 4 byte string, where the first byte is Year, the second and third are Hour and the fourth is Minute.

Examples:

Send **ETC** to query elapsed time:

0x07	0xFF	0x45	0x54	0x43	0x00	0x1D
------	------	------	------	------	------	------

ACK Year, Hour, Minute

06	FF	45	54	43	04	1A	Year	Hour(H)	Hour(L)	Minute	IDCHK
----	----	----	----	----	----	----	------	---------	---------	--------	-------

GMB (Glass Display Control - Minimum Brightness)

This command sets the minimum value for the brightness of the touch keypad LED. Be sure to configure this setting to a value that will ensure that the LED indicators are still visible if they are adjusted down to this minimum value. The range starts from 0x00 to 0x31 (0% to 100%). LEN = one byte.

Examples:

Command to set 30% Brightness.

0x07	0xFF	0x47	0x4D	0x42	0x01	0x22	0x10	0xEF
------	------	------	------	------	------	------	------	------

POT (Potentiometer Control)

The BR+/BR- key default value is **Enable**. Users can send this command to disable/enable the BR+/BR- key. If the data and data checksum are incorrect, the reply data field is the current control status. LEN=one data byte.

0x00	Brightness +/Brightness - Key Disable
0xFF	Brightness +/Brightness - Key Enable

Examples:

Disable the BR+/BR- Key.

0x07	0xFF	0x50	0x4F	0x54	0x01	0x05	0x00	0xFF
------	------	------	------	------	------	------	------	------

ACK

0x06	0xFF	0x50	0x4F	0x54	0x01	0x06	0x00	0xFF
------	------	------	------	------	------	------	------	------

SWI (Scalar Firmware Version Query)

This command queries the scalar firmware version.

Examples:

Query Scalar Firmware Version

0x07	0xFF	0x53	0x57	0x49	0x00	0x06
------	------	------	------	------	------	------

SWK (Touch Keypad Firmware Version Query)

This command queries the touch keypad firmware version.

Examples:

Query Touch Keypad Firmware Version

0x07	0xFF	0x53	0x57	0x4B	0x00	0x04
------	------	------	------	------	------	------

ADF (AC Input Power Detect Function)

This default value of this function is **OFF**. If the MD-219 supports an AC power input, you can turn on this function to detect the AC input power when the MD-219 has connected to the AC power. LEN=one data byte.

0x00	AC Input Power Detect is OFF
0xFF	AC Input Power Detect is ON

Examples:

Set "OFF".

0x07	0xFF	0x41	0x44	0x46	0x01	0x2D	0x00	0xFF
------	------	------	------	------	------	------	------	------

ACK

0x06	0xFF	0x41	0x44	0x46	0x01	0x2E	0x00	0xFF
------	------	------	------	------	------	------	------	------

AD? (Query AC Input Power Detect Function Status)

If the MD-219 supports an AC power input, you can use this command to query the AC Input Power Detect Function Status.

0x00	AC Input Power Detect is OFF
0xFF	AC Input Power Detect is ON

Examples:

Send an **AD?** command to Query the AC Input Power Detect Function Status

0x07	0xFF	0x41	0x44	0x3F	0x00	0x35
------	------	------	------	------	------	------

ACK

0x06	0xFF	0x41	0x44	0x3F	0x01	0x35	0x00	0xFF
------	------	------	------	------	------	------	------	------

DDF (DC Input Power Detect Function)

This default value of this function **OFF**. Turn on this function to detect the DC input power when this unit supports and is connected to DC power. LEN=one data byte.

0x00	DC Input Power Detect is OFF
0xFF	DC Input Power Detect is ON

Examples:

Set "OFF".

0x07	0xFF	0x44	0x44	0x46	0x01	0x2A	0x00	0xFF
------	------	------	------	------	------	------	------	------

ACK

0x06	0xFF	0x44	0x44	0x46	0x01	0x2B	0x00	0xFF
------	------	------	------	------	------	------	------	------

DD? (Query DC Input Power Detect Function Status)

Send this command to query DC Input Power Detect Function Status

0x00	DC Input Power Detect is OFF
0xFF	DC Input Power Detect is ON

Examples:

Send a **DD?** command to Query the DC Input Power Detect Function Status

0x07	0xFF	0x44	0x44	0x3F	0x00	0x32
------	------	------	------	------	------	------

ACK

0x06	0xFF	0x44	0x44	0x3F	0x01	0x32	0x00	0xFF
------	------	------	------	------	------	------	------	------

BLI (Brightness Control)

Use this command to set the panel Brightness. The Brightness range is from 0x00 to 0xFF. The default Brightness is 160. LEN=one data byte.

Examples:

Set brightness to 255(0xFF)

0x07	0xFF	0x42	0x4C	0x49	0x01	0x21	0xFF	0x00
------	------	------	------	------	------	------	------	------

ACK

0x06	0xFF	0x42	0x4C	0x49	0x01	0x22	0xFF	0x00
------	------	------	------	------	------	------	------	------

Query current brightness value

0x07	0xFF	0x42	0x4C	0x49	0x00	0x22
------	------	------	------	------	------	------

ACK

0x06	0xFF	0x42	0x4C	0x49	0x01	0x22	0xFF	0x00
------	------	------	------	------	------	------	------	------

DUF (Disable UART Command Function)

Use this command to disable command controls. LEN=one data byte.

DATA	IDCHK	Function description
0x00	0xFF	Disable all command control
0x01	0xFE	Disable BRI control
0x02	0xFD	Disable BRL control
0x04	0xFB	Disable BRM control
0x08	0xF7	Disable BZZ control
0x10	0xEF	Reserved
0x20	0xDF	Disable GMB control
0x40	0xBF	Disable POT control

Examples:

Disable all command controls

0x07	0xFF	0x44	0x55	0x46	0x01	0x19	0x00	0xFF
------	------	------	------	------	------	------	------	------

ACK

0x06	0xFF	0x44	0x55	0x46	0x01	0x1A	0x00	0xFF
------	------	------	------	------	------	------	------	------

NACK

0x15	0xFF	0x44	0x55	0x46	0x01	0x0B	0x00	0xFF
------	------	------	------	------	------	------	------	------

EMS (ECDIS Mode Select)

For ECDIS models, use this command to switch between DAY, DUSK, and NIGHT modes. LEN=one data byte.

	DATA	IDCHK
DAY	0x00	0xFF
DUSK	0x01	0xFE
NIGHT	0x02	0xFD
QUERY	0x3F	0xC0
	ACK = 0x00 (DAY Mode)	
	ACK = 0x01 (DUSK Mode)	
	ACK = 0x01 (NIGHT Mode)	
	ACK = 0x03 (Not at DAY, DUSK and NIGHT Mode)	

Examples:

Switch to DUSK mode

0x07	0xFF	0x45	0x4D	0x53	0x01	0x13	0x01	0xFE
------	------	------	------	------	------	------	------	------

ACK

0x06	0xFF	0x45	0x4D	0x53	0x01	0x14	0x01	0xFE
------	------	------	------	------	------	------	------	------

NACK

0x15	0xFF	0x45	0x4D	0x53	0x01	0x0B	0x01	0xFE
------	------	------	------	------	------	------	------	------

Query current mode

0x07	0xFF	0x45	0x4D	0x53	0x01	0x13	0x3F	0xC0
------	------	------	------	------	------	------	------	------

ACK = 0x01 (DUSK Mode)

0x06	0xFF	0x45	0x4D	0x53	0x01	0x14	0x01	0xFE
------	------	------	------	------	------	------	------	------

CT? (Current Temperature Query)

Send this command to Query Current Temperature

DATA	Return Current Temperature
------	----------------------------

Examples:

Send **CT?** command to Query Current Temperature

0x07	0xFF	0x43	0x54	0x3F	0x00	0x23
------	------	------	------	------	------	------

ACK

0x06	0xFF	0x43	0x54	0x3F	0x01	0x23	DATA	IDCHK
------	------	------	------	------	------	------	------	-------

ACK 0 degree Celsius (-64 ~ + 127)

0x06	0xFF	0x43	0x54	0x3F	0x01	0x23	0x00	0xBF
------	------	------	------	------	------	------	------	------

ACK -128 degree Celsius (over representation range)

0x06	0xFF	0x43	0x54	0x3F	0x01	0x23	0x80	0x7F
------	------	------	------	------	------	------	------	------

SS? (System Status Query)

Send this command to Query System Status information (INFO button item)

DATA	Return Current Temperature
Bit0	1 : AC Input Power is "OFF" , 0 : AC Input Power is "ON"
Bit1	1 : DC Input Power is "OFF" , 0 : DC Input Power is "ON"
Bit2-7	Reserved

Examples:

Send **SS?** command to Query System Status

0x07	0xFF	0x53	0x53	0x3F	0x00	0x14
------	------	------	------	------	------	------

ACK

0x06	0xFF	0x53	0x53	0x3F	0x01	0x14	DATA	IDCHK
------	------	------	------	------	------	------	------	-------

MCC (OSD Control Command)

This command gives remote access to the unit's OSD menu settings. The commands are transmitted in the DATA field.

NOTE We cannot guarantee that all commands will be supported by future Moxa products.

If the checksum is valid, the unit will reply to this command with an ACK attention code, where the data field contains the original "MCC" command followed by acknowledge from the controller. If the checksum is invalid and the message was not broadcast, the unit will reply to this command with a NAK attention code, where the data field contains the original command or some status of some functions.

NOTE The MCC command is not supported by Moxa panel computers, since they do not have an OSD menu.

We assume that you already know how to send, receive, and interpret the commands after having studied the examples before to the "MCC" command table below. The list below is a compressed version of the HEX values you need to send and will apply to all units (ADDR set as "FF"). For readability, the prefix "0x" has been removed from the table and is shown as a complete HEX string with values from 00 to FF (2 by 2 letters). Every command will contain the "MCC" (0x4D, 0x43, 0x43) ASCII letters as a default indicator.

The functional byte positions in the table below are indicated in red. The values (xx,yy) should always be sent in HEX format (not decimal format). For example, if you would like to enter the number 64 (in decimal format), you should enter the HEX equivalent, which is 0x40. The single byte that represents the MCC Command ID is shown in green. The checksum is shown in blue. The other byte positions in black are defined as in the "Message Format" shown at the beginning of this chapter.

NOTE Due to firmware revisions, some commands listed below will not be supported by earlier units.

MCC Command	Syntax and Functionality	Details and Values
Brightness Control	Syntax: 07 FF 4D 43 43 03 23 81 xx yy zz <u>Function Examples:</u> Example "255": 07 FF 4D 43 43 03 23 81 46 46 F2 Query "?": 07 FF 4D 43 43 02 24 81 3F 3F Reset "R": 07 FF 4D 43 43 02 24 81 52 2C Reset "r": 07 FF 4D 43 43 02 24 81 72 0C Increase "+": 07 FF 4D 43 43 02 24 81 2B 53 Decrease "-": 07 FF 4D 43 43 02 24 81 2D 51	Where xx = "0" to "F" Where yy = "0" to "F" Where zz = Calculated Checksum Max Range: "0" "0" to "F" "F" Default: "A" "0" (160)
Contrast Control	Syntax: 07 FF 4D 43 43 04 22 82 ww xx yy zz <u>Function Examples:</u> Example "A00": 07 FF 4D 43 43 04 22 82 41 30 30 DC Example "a00": 07 FF 4D 43 43 04 22 82 61 30 30 BC Query "?": 07 FF 4D 43 43 02 24 82 3F 3E Reset "R": 07 FF 4D 43 43 02 24 82 52 2B Reset "r": 07 FF 4D 43 43 02 24 82 72 0B Increase "+": 07 FF 4D 43 43 02 24 82 2B 52 Decrease "-": 07 FF 4D 43 43 02 24 82 2D 50	Where ww = "a" to "A" Where xx = "0" to "6" Where yy = "0" to "F" Where zz = Calculated Checksum Max Range: "0" "0" to "6" "4" Default: "0" "0"
Manual Clock Control	Syntax: 07 FF 4D 43 43 02 24 85 xx zz <u>Function Examples:</u> Increase "+": 07 FF 4D 43 43 02 24 85 2B 4F Decrease "-": 07 FF 4D 43 43 02 24 85 2D 4D	For VGA Mode only
Image Horizontal Position	Syntax: 07 FF 4D 43 43 02 24 86 xx zz <u>Function Examples:</u> Increase "+": 07 FF 4D 43 43 02 24 86 2B 4E Decrease "-": 07 FF 4D 43 43 02 24 86 2D 4C	For VGA Mode only
Image Vertical Position	Syntax: 07 FF 4D 43 43 02 24 87 xx zz <u>Function Examples:</u> Increase "+": 07 FF 4D 43 43 02 24 87 2B 4D Decrease "-": 07 FF 4D 43 43 02 24 87 2D 4B	For VGA Mode only
Auto Source	Syntax: 07 FF 4D 43 43 02 24 88 xx zz <u>Function Examples:</u> Example "1": 07 FF 4D 43 43 02 24 88 31 46 Query "?": 07 FF 4D 43 43 02 24 88 3F 38 Reset "R": 07 FF 4D 43 43 02 24 88 52 25 Reset "r": 07 FF 4D 43 43 02 24 88 72 05	Where xx = "0" to "1" Where zz = Calculated Checksum Available function: "0" = Disble "1" = Enable
OSD Lock Mode	Syntax: 07 FF 4D 43 43 02 24 8D xx zz <u>Function Examples:</u> Example "1": 07 FF 4D 43 43 02 24 8D 31 41 Query "?": 07 FF 4D 43 43 02 24 8D 3F 33 Reset "R": 07 FF 4D 43 43 02 24 8D 52 20 Reset "r": 07 FF 4D 43 43 02 24 8D 72 00 Set "999": 07 FF 4D 43 43 05 21 8D 53 39 39 39 74	Where xx = "0" to "1" Where zz = Calculated Checksum Available function: "0" = Normal (default) "1" = Menu Protection "S" = Set password (default is "000")

MCC Command	Syntax and Functionality	Details and Values
Auto Adjustment	Syntax: 07 FF 4D 43 43 02 24 8F xx zz <u>Function Examples:</u> Example "1": 07 FF 4D 43 43 02 24 8F 31 3F Query "?": 07 FF 4D 43 43 02 24 8F 3F 31	For VGA Mode only Where xx = "0" to "1" Where zz = Calculated Checksum Available function: "0" = Off (default) "1" = On (do auto adjustment) Note: Auto adjustment will be executed when previous auto adjusting is finished.
OSD Horizontal Position	Syntax: 07 FF 4D 43 43 03 23 90 xx yy zz <u>Function Examples:</u> Example "50": 07 FF 4D 43 43 03 23 90 35 30 0A Query "?": 07 FF 4D 43 43 02 24 90 3F 30 Reset "R": 07 FF 4D 43 43 02 24 90 52 1D Reset "r": 07 FF 4D 43 43 02 24 90 72 FD Increase "+": 07 FF 4D 43 43 02 24 90 2B 44 Decrease "-": 07 FF 4D 43 43 02 24 90 2D 42	Where xx = "0" to "6" Where yy = "0" to "F" Where zz = Calculated Checksum Max Range: "0" "0" to "6" "4" Default: "6" "4" (100) Note: If Value > 100 then Value=100.
OSD Vertical Position	Syntax: 07 FF 4D 43 43 03 23 91 xx yy zz <u>Function Examples:</u> Example "50": 07 FF 4D 43 43 03 23 91 35 30 09 Query "?": 07 FF 4D 43 43 02 24 91 3F 2F Reset "R": 07 FF 4D 43 43 02 24 91 52 1C Reset "r": 07 FF 4D 43 43 02 24 91 72 FC Increase "+": 07 FF 4D 43 43 02 24 91 2B 43 Decrease "-": 07 FF 4D 43 43 02 24 91 2D 41	Where xx = "0" to "6" Where yy = "0" to "F" Where zz = Calculated Checksum Max Range: "0" "0" to "6" "4" Default: "6" "4" (100) Note: If Value > 100 then Value=100.
Select OSD Language	Syntax: 07 FF 4D 43 43 02 24 95 xx zz <u>Function Examples:</u> Example "0": 07 FF 4D 43 43 02 24 95 30 3A Query "?": 07 FF 4D 43 43 02 24 95 3F 2B Reset "R": 07 FF 4D 43 43 02 24 95 52 18 Reset "r": 07 FF 4D 43 43 02 24 95 72 F8	Where xx = "0" Where zz = Calculated Checksum Available function: "0" = English (default) ※Only support English now
Main Input Select	Syntax: 07 FF 4D 43 43 02 24 98 xx zz <u>Function Examples:</u> Example "0": 07 FF 4D 43 43 02 24 98 30 37 Query "?": 07 FF 4D 43 43 02 24 98 3F 28 Reset "R": 07 FF 4D 43 43 02 24 98 52 15 Reset "r": 07 FF 4D 43 43 02 24 98 72 F5	Where xx = "0" to "1" Where zz = Calculated Checksum Available function: "0" = DVI (default) "1" = VGA
Communication Mode	Syntax: 07 FF 4D 43 43 02 24 99 xx zz <u>Function Examples:</u> Example "0": 07 FF 4D 43 43 02 24 99 30 36 Query "?": 07 FF 4D 43 43 02 24 99 3F 27 Reset "R": 07 FF 4D 43 43 02 24 99 52 14 Reset "r": 07 FF 4D 43 43 02 24 99 72 F4	Where xx = "0" to "5" Where zz = Calculated Checksum Available function: "0" = DB9_RS232 "1" = TB_RS4852W "2" = TB_RS422 ※DB9 and Terminal block connector
Power Down/Up Display	Syntax: 07 FF 4D 43 43 02 24 9F xx zz <u>Function Examples:</u> Example "1": 07 FF 4D 43 43 02 24 9F 31 2F Query "?": 07 FF 4D 43 43 02 24 9F 3F 21 Reset "R": 07 FF 4D 43 43 02 24 9F 52 0E Reset "r": 07 FF 4D 43 43 02 24 9F 72 EE	Where xx = "0" to "1" Where zz = Calculated Checksum Available function: "0" = Power Off "1" = Power On (default)

MCC Command	Syntax and Functionality	Details and Values
Color Temperature Select	Syntax: 07 FF 4D 43 43 02 24 B3 xx zz <u>Function Examples:</u> Example "2": 07 FF 4D 43 43 02 24 B3 32 1A Query "?": 07 FF 4D 43 43 02 24 B3 3F 0D Reset "R": 07 FF 4D 43 43 02 24 B3 52 FA Reset "r": 07 FF 4D 43 43 02 24 B3 72 DA	Where xx = "0" to "2" Where zz = Calculated Checksum Available function: "0" = 9300K "1" = 7500K "2" = 6500K (default)
Red Level for Selected Color	Syntax: 07 FF 4D 43 43 03 23 B4 xx yy zz <u>Function Examples:</u> Example "50": 07 FF 4D 43 43 03 23 B4 35 30 E6 Query "?": 07 FF 4D 43 43 02 24 B4 3F 0C Reset "R": 07 FF 4D 43 43 02 24 B4 52 F9 Reset "r": 07 FF 4D 43 43 02 24 B4 72 D9 Increase "+": 07 FF 4D 43 43 02 24 B4 2B 20 Decrease "-": 07 FF 4D 43 43 02 24 B4 2D 1E	Where xx = "0" to "6" Where yy = "0" to "F" Where zz = Calculated Checksum Max Range: "0" "0" to "6" "4" Default: "6" "4" (100)
Green Level for Selected Color	Syntax: 07 FF 4D 43 43 03 23 B5 xx yy zz <u>Function Examples:</u> Example "50": 07 FF 4D 43 43 03 23 B5 35 30 E5 Query "?": 07 FF 4D 43 43 02 24 B5 3F 0B Reset "R": 07 FF 4D 43 43 02 24 B5 52 F8 Reset "r": 07 FF 4D 43 43 02 24 B5 72 D8 Increase "+": 07 FF 4D 43 43 02 24 B5 2B 1F Decrease "-": 07 FF 4D 43 43 02 24 B5 2D 1D	Where xx = "0" to "6" Where yy = "0" to "F" Where zz = Calculated Checksum Max Range: "0" "0" to "6" "4" Default: "6" "4" (100)
Blue Level for Selected Color	Syntax: 07 FF 4D 43 43 03 23 B6 xx yy zz <u>Function Examples:</u> Example "50": 07 FF 4D 43 43 03 23 B6 35 30 E4 Query "?": 07 FF 4D 43 43 02 24 B6 3F 0A Reset "R": 07 FF 4D 43 43 02 24 B6 52 F7 Reset "r": 07 FF 4D 43 43 02 24 B6 72 D7 Increase "+": 07 FF 4D 43 43 02 24 B6 2B 1E Decrease "-": 07 FF 4D 43 43 02 24 B6 2D 1C	Where xx = "0" to "6" Where yy = "0" to "F" Where zz = Calculated Checksum Max Range: "0" "0" to "6" "4" Default: "6" "4" (100)
Graphic Horizontal Resolution Query	Send only: 07 FF 4D 43 43 01 25 B7 48	Available response status: "xxx" = where xxx is a 3-digit HEX number indicating resolution. Example: "0780" = 1920 in decimal
Graphic Vertical Resolution Query	Send only: 07 FF 4D 43 43 01 25 B8 47	Available response status: "xxx" = where xxx is a 3-digit HEX number indicating resolution. Example: "0480" = 1200 in decimal
Graphic Horizontal Sync. Frequency	Send only: 07 FF 4D 43 43 01 25 B9 46	Available response status: "xxx" = where xxx is a 3-digit HEX number indicating frequency in units of 100Hz. Example: "2A3" = 675 or 67.5 kHz decimal

MCC Command	Syntax and Functionality	Details and Values
Graphic Vertical Sync. Frequency	Send only: 07 FF 4D 43 43 01 25 BA 45	Available response status: "xxx" = where xxx is a 3-digit HEX number indicating frequency in units of 0.1Hz + 1 character indicating field mode as: "i" = Interlaced "p" = Progressive Example: "258p" = 600 (60 Hz), progressive fields
Set Address RS/Serial	Syntax: 07 FF 4D 43 43 02 24 BB xx zz <u>Function Example:</u> Example "9": 07 FF 4D 43 43 02 24 BB 39 0B Query "?": 07 FF 4D 43 43 02 24 BB 3F 05 Reset "R": 07 FF 4D 43 43 02 24 BB 52 F2 Reset "r": 07 FF 4D 43 43 02 24 BB 72 D2	Where xx = "0" to "F" Where zz = Calculated Checksum Default and reset value are "0"
Test Pattern	Syntax: 07 FF 4D 43 43 02 24 CD xx zz <u>Function Examples:</u> Example "1": 07 FF 4D 43 43 02 24 CD 31 01	Where xx = "0" to "1" Where zz = Calculated Checksum Available function: "0" = Normal Display "1" = Display burn-in Test Pattern
Reset Factory Default	Send only: 07 FF 4D 43 43 01 25 CE 31	Available response status: "0" = fail "1" = successful
Menu Button	Send only: 07 FF 4D 43 43 01 25 F7 08	Physical Button press equivalent
Down Button	Send only: 07 FF 4D 43 43 01 25 FA 05	Physical Button press equivalent
Up Button	Send only: 07 FF 4D 43 43 01 25 FB 04	Physical Button press equivalent
ECDIS Button	Send only: 07 FF 4D 43 43 01 25 FC 03	Physical Button press equivalent
INFO Button	Send only: 07 FF 4D 43 43 01 25 FD 02	Physical Button press equivalent