

WAC-1001 User's Manual

Edition 5.0, February 2017

www.moxa.com/product

MOXA[®]

© 2017 Moxa Inc. All rights reserved.

WAC-1001 User's Manual

The software described in this manual is furnished under a license agreement and may be used only in accordance with the terms of that agreement.

Copyright Notice

© 2017 Moxa Inc. All rights reserved.

Trademarks

The MOXA logo is a registered trademark of Moxa Inc.
All other trademarks or registered marks in this manual belong to their respective manufacturers.

Disclaimer

Information in this document is subject to change without notice and does not represent a commitment on the part of Moxa.

Moxa provides this document as is, without warranty of any kind, either expressed or implied, including, but not limited to, its particular purpose. Moxa reserves the right to make improvements and/or changes to this manual, or to the products and/or the programs described in this manual, at any time.

Information provided in this manual is intended to be accurate and reliable. However, Moxa assumes no responsibility for its use, or for any infringements on the rights of third parties that may result from its use.

This product might include unintentional technical or typographical errors. Changes are periodically made to the information herein to correct such errors, and these changes are incorporated into new editions of the publication.

Technical Support Contact Information

www.moxa.com/support

Moxa Americas

Toll-free: 1-888-669-2872
Tel: +1-714-528-6777
Fax: +1-714-528-6778

Moxa Europe

Tel: +49-89-3 70 03 99-0
Fax: +49-89-3 70 03 99-99

Moxa India

Tel: +91-80-4172-9088
Fax: +91-80-4132-1045

Moxa China (Shanghai office)

Toll-free: 800-820-5036
Tel: +86-21-5258-9955
Fax: +86-21-5258-5505

Moxa Asia-Pacific

Tel: +886-2-8919-1230
Fax: +886-2-8919-1231

Table of Contents

1. Introduction	1-1
Overview	1-2
Package Checklist	1-2
Product Features	1-2
Product Specifications (WAC-1001 Rev 2.xx.x)	1-3
Functional Design	1-4
LED Indicators	1-4
Beeper	1-4
Reset Button	1-4
Relay (Digital Output)	1-5
2. Getting Started	2-1
First-time Installation and Configuration	2-2
Function Map	2-4
3. Web Console Configuration	3-1
Web Browser Configuration	3-2
Overview	3-4
Basic Settings	3-4
System Info Settings	3-4
Network Settings	3-5
Time Settings	3-6
Controller Settings	3-7
Basic WAC Settings	3-7
WLAN Security Settings	3-9
Advanced Settings	3-10
SNMP Agent	3-10
Auto Warning Settings	3-11
System Log	3-12
Syslog	3-12
E-mail	3-14
Relay	3-15
Trap	3-15
Status	3-17
System Log	3-17
Relay Status	3-17
DI and Power Status	3-18
Managed Device List	3-18
LAN Status	3-19
Maintenance	3-19
Console Settings	3-19
Ping	3-19
Firmware Upgrade	3-20
Config Import Export	3-20
Load Factory Default	3-22
Username/Password	3-22
Locate Device	3-22
Misc. Settings	3-23
Save Configuration	3-23
Restart	3-24
Logout	3-24
4. Software Installation and Configuration	4-1
Overview	4-2
AWK Search Utility	4-2
Installing AWK Search Utility	4-2
Configuring AWK Search Utility	4-4
5. Other Console Considerations	5-1
RS-232 Console Configuration (115200, None, 8, 1, VT100)	5-2
Configuration by Telnet and SSH Consoles	5-3
Configuration by Web Browser with HTTPS/SSL	5-4
Disabling Telnet and Browser Access	5-5
A. References	A-1
Roaming Domain	A-2
Roaming Method	A-3
Compare	A-3
B. Supporting Information	B-1
About This User's Manual	B-2
DoC (Declaration of Conformity)	B-3

Federal Communication Commission Interference Statement	B-3
Firmware Recovery	B-3

Introduction

The WAC-1001 is rated to operate at temperatures ranging from 0 to 60°C for standard models and -40 to 75°C for wide temperature models, and is rugged enough for any harsh industrial environment.

The following topics are covered in this chapter:

- ❑ **Overview**
- ❑ **Package Checklist**
- ❑ **Product Features**
- ❑ **Product Specifications (WAC-1001 Rev 2.xx.x)**
- ❑ **Functional Design**
 - LED Indicators
 - Beeper
 - Reset Button
 - Relay (Digital Output)

Overview

The WAC-1001 Wireless Access Controller which is used to enabling layer 2 controller based roaming for the RTG series. It is ideal for applications that are hard to wire, too expensive to wire, or use mobile equipment that connects to a TCP/IP network. The WAC-1001 can operate at temperatures ranging from 0 to 60°C for standard models and -40 to 75°C for extended temperature models, and is rugged enough for any harsh industrial environment. Installation is easy, with either DIN-Rail mounting or wall mounting in distribution boxes. The WAC-1001 with its wide operating temperature range, IP30-rated housing with LED indicators, and DIN-Rail/wall mount is a convenient yet reliable solution for all types of industrial wireless applications.

Package Checklist

Moxa's WAC-1001 is shipped with the following items. If any of these items is missing or damaged, please contact your customer service representative for assistance.

- WAC-1001 series wireless controller
- 1 cable holder with 1 screw
- 2 protective caps
- Wall mount kit
- Quick installation guide
- Software CD
- Warranty card

NOTE The above items come with the standard WAC-1001 model, but the package contents may vary for customized versions.

Product Features

- Advanced Turbo Roaming Support
 - Less-than-50 ms handover
 - Wireless security: WPA/WPA2-Personal/Enterprise
- Central Management Functions
 - Wireless security setting
- Free firmware update for more advanced functions
- RS-232 console management
- 2DI+1DO for on-site monitoring and warnings
- Wide -40 to 75°C operating temperature range (-T model)
- Redundant 24 VDC power inputs or IEEE802.3af Power over Ethernet
- DIN-Rail or wall mounting
- IP30-rated heavy-duty metal housing

Product Specifications (WAC-1001 Rev 2.xx.x)

WLAN Interface

Standards:

IEEE 802.1x (Radius client)
IEEE 802.3u for 10/100BaseT(X) for Ethernet LAN
IEEE 802.3af for Power-over-Ethernet

Supported Models:

- AWK-3121-M12-RTG
- AWK-3121-SSC-RTG

Interface

LAN Ports: 1, 10/100/1000BaseT(X), auto negotiation speed (RJ45-type)

Console for External Antenna: RS-232 (RJ45-type)

LED Indicators: PWR1, PWR2, PoE, FAULT, STATE, LAN

Alarm Contact: 1 relay output with current carrying capacity of 1 A @ 24 VDC

Digital Inputs:

2 electrically isolated inputs

- +13 to +30 V for state "1" (ON)
- +3 to -30 V for state "0" (OFF)
- Max. input current: 8 mA

Physical Characteristics

Housing: Metal, providing IP30 protection

Weight: 1060 g

Dimensions: 52.85 x 135 x 105 mm (2.08 x 5.31 x 4.13 in)

Installation: DIN-Rail mounting, wall mounting (optional)

Environmental Limits

Operating Temperature:

Standard Models: 0 to 60°C (32 to 140°F)

Wide Temp. Models: -40 to 75°C (-40 to 167°F)

Storage Temperature: -40 to 85°C (-40 to 185°F)

Ambient Relative Humidity: 5 to 95% (non-condensing)

Power Requirements

Input Voltage: 12 to 48 VDC, redundant dual DC power inputs or 48 VDC Power-over-Ethernet (IEEE 802.3af compliant)

Connector: 10-pin removable terminal block, 500 V insulation

Power Consumption: Max. 7.2 W (12V/0.6A to 48V/0.15A), 25°C

Reverse Polarity Protection: Present

Standards and Certifications

Safety: EN 60950-1(LVD), UL 60950-1, IEC 60950-1(CB)

EMC: EN 55032/24

EMI: CISPR 32, FCC Part 15B, Class A

EMS:

IEC 61000-4-2 ESD: Contact 8 kV; Air: 15 kV

IEC 61000-4-3 RS: 80 MHz to 1 GHz: 10 V/m

IEC 61000-4-4 EFT: Power: 2 kV; Signal: 1 kV

IEC 61000-4-5 Surge: Power: 2 kV; Signal: 1 kV

EN 61000-4-6 CS: 10 V

EN 61000-4-8

Note: Please check Moxa's website for the most up-to-date certification status.

Warranty

Warranty Period: 5 years

Details: See www.moxa.com/warranty



ATTENTION

The WAC-1001 is NOT designed for use by the general public. A well-trained technician is required to safely deploy the WAC-1001.

Patent http://www.moxa.com/doc/operations/Moxa_Patent_Marking.pdf

Functional Design

LED Indicators

The LEDs on the front panel of the WAC-1001 provide a quick and easy means of determining the current operational status and wireless settings.

The **FAULT** LED indicates system failures and user-configured events. If the WAC-1001 cannot retrieve an IP address from a DHCP server, the **FAULT** LED will blink at one second intervals.

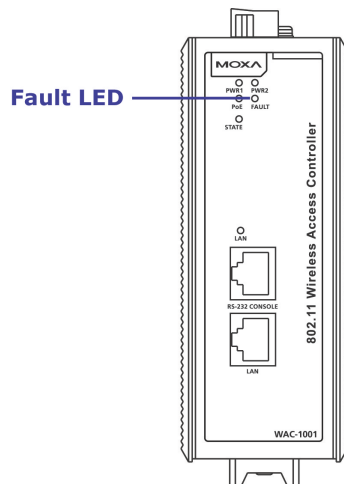

Beeper

The beeper emits two short beeps when the system is ready.

Reset Button

The **RESET button** is located on the top panel of the WAC-1001. You can reboot the WAC-1001 or reset it to the factory default settings by pressing the **RESET button** with a pointed object such as an unfolded paper clip.

- **System reboot:** Press and release the **RESET button**
- **Reset to factory default:** Depress the **RESET button** for *more than* 5 seconds until the **STATE** LED starts blinking green, and then release.

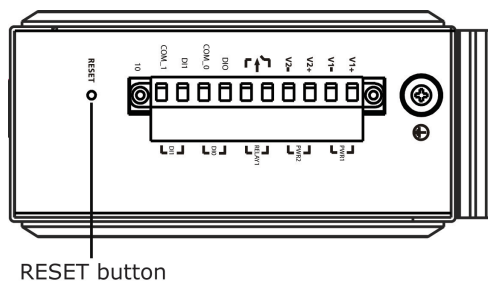

Relay (Digital Output)

The WAC-1001 has one relay output consisting of the 2 terminal block contacts on the top panel, as shown below. These relay contacts are used to forward system failures and user-configured events.

The two wires attached to the relay contacts form an open circuit when a user-configured event is triggered. If a user-configured event does not occur, the relay circuit will remain closed. For safety reasons, the relay circuit is kept open when the WAC-1001 is not powered up.

Summary of the WAC-1001's Relay Status

Power Status	Event	Relay
Off	–	Open
On	Yes	Open
	No	Short

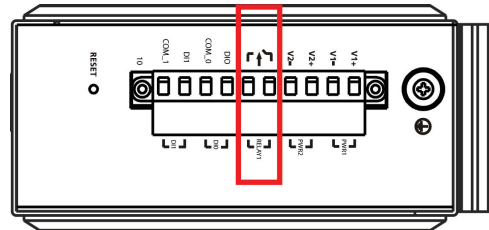

2

Getting Started

This chapter explains how to install the WAC-1001 for the first time, and quickly set up your wireless network. The Function Map provides a convenient means of determining which functions you need to use.

The following topics are covered in this chapter:

- ❑ **First-time Installation and Configuration**
- ❑ **Function Map**

First-time Installation and Configuration

Before installing the WAC-1001, make sure that all items in the Package Checklist are in the box. You will need access to a notebook computer or PC equipped with an Ethernet port. The WAC-1001 has a default IP address that must be used when connecting to the device for the first time.

- **Step 1: Select the power source.**

The WAC-1001 can be powered by a DC power input or PoE (Power over Ethernet). The WAC-1001 will use whichever power source you choose.

- **Step 2: Connect the WAC-1001 to a notebook or PC.**

Since the WAC-1001 supports MDI/MDI-X auto-sensing, you can use either a straight-through cable or crossover cable to connect the WAC-1001 to a computer. The LED indicator on the WAC-1001's LAN port will light up when a connection is established.

- **Step 3: Set up the computer's IP address.**

Choose an IP address on the same subnet as the WAC-1001. Since the WAC-1001's default IP address is **192.168.127.253**, and the subnet mask is **255.255.255.0**, you should set the IP address of the computer to **192.168.127.xxx**.

NOTE After you select **Maintenance** → **Load Factory Default** and click the **Submit** button, the WAC-1001 will be reset to factory default settings and the IP address will be reset to **192.168.127.253**.

- **Step 4: Use the web-based manager to configure the WAC-1001**

Open your computer's web browser and type **http://192.168.127.253** in the address field to access the homepage of the web-based Network Manager. Before the homepage opens, you will need to enter the user name and password as shown in the following figure. For first-time configuration, enter the default user name and password and then click on the **Login** button:

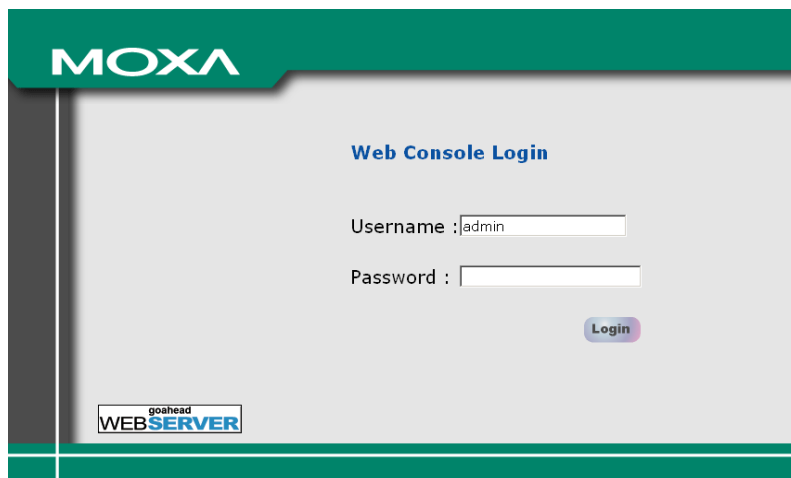

NOTE Default user name and password:

User Name: **admin**

Password: **root**

For security reasons, we strongly recommend changing the default password. To do so, select **Maintenance** → **Password**, and then follow the on-screen instructions to change the password.

- **Step 5: Set up Roaming domain**

The first time you log into the WAC-1001, a warning message will be displayed on your computer's web browser to remind you to set the value of the **Roaming domain**. Click **Yes** to go to **Controller Settings** → **Basic WAC Settings** to set up the **Roaming domain**. If the **Roaming domain** is not configured, the WAC-1001 will not function properly. Note that the AP and clients in the same roaming domain **MUST** be configured and grouped in the same subnet.

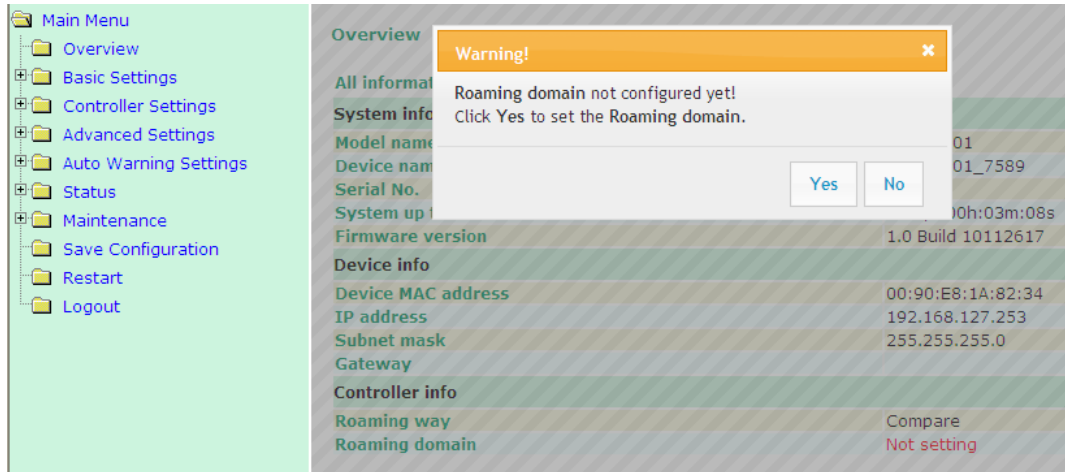

- **Step 6: More settings to better configure the WAC-1001**

On the WAC-1001's web-based UI, there are additional setting options for a more customized configuration. Refer to the following chapters for more details.

NOTE After clicking Submit to apply changes, the web page will refresh and (Updated) will appear on the page, and at the same time a flashing reminder on the upper-right corner of the web page will be displayed as shown below:



To activate the changes, click the Restart button, and then the Save and Restart button. It will take about 40 seconds for the WAC-1001 to complete the reboot procedure.

Function Map

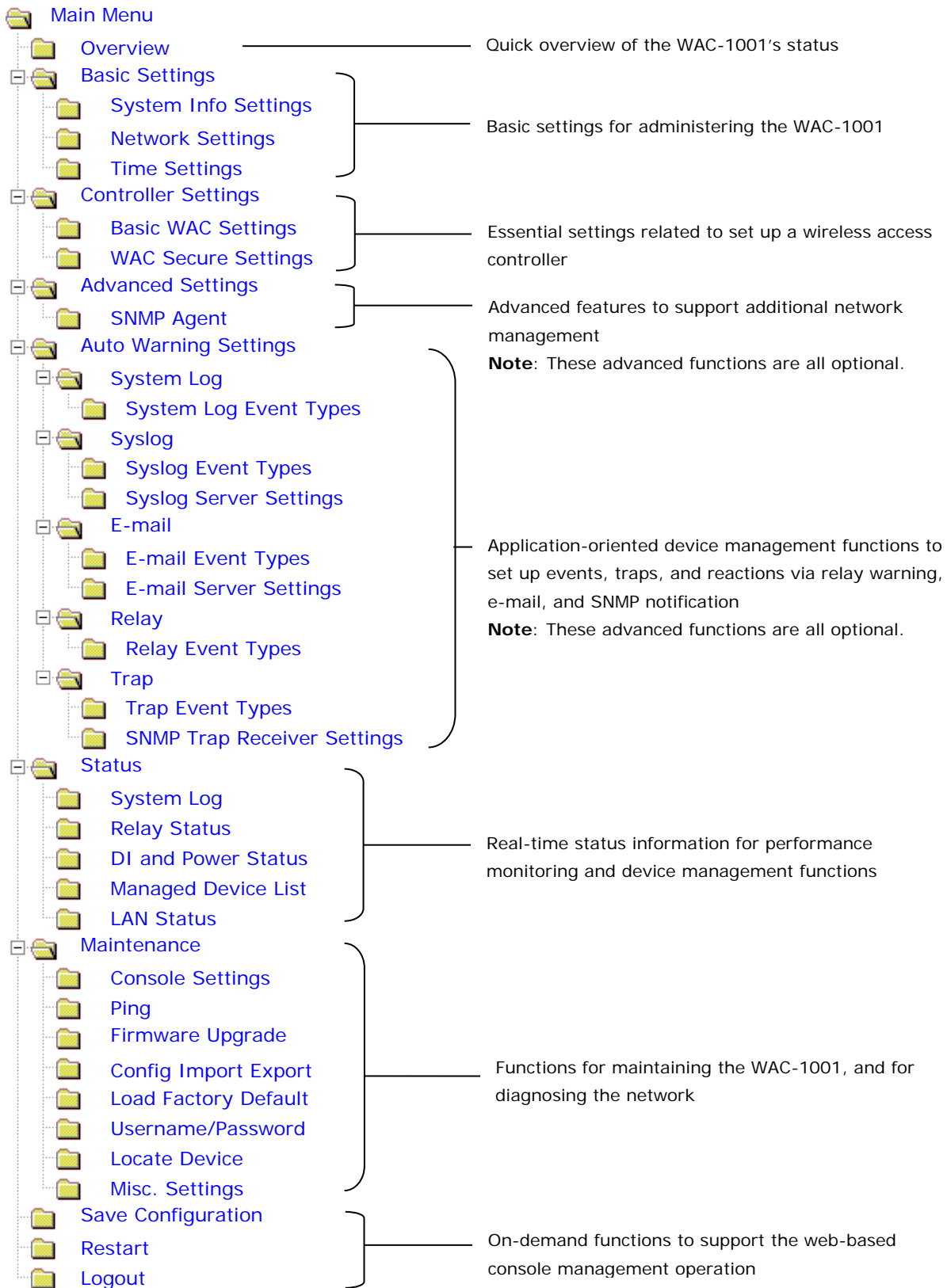

Web Console Configuration

In this chapter, we explain all aspects of web-based console configuration. Moxa's easy-to-use management functions help you set up your WAC-1001.

The following topics are covered in this chapter:

❑ **Web Browser Configuration**

❑ **Overview**

❑ **Basic Settings**

- System Info Settings
- Network Settings
- Time Settings

❑ **Controller Settings**

- Basic WAC Settings
- WLAN Security Settings

❑ **Advanced Settings**

- SNMP Agent

❑ **Auto Warning Settings**

- System Log
- Syslog
- E-mail
- Relay
- Trap

❑ **Status**

- System Log
- Relay Status
- DI and Power Status
- Managed Device List
- LAN Status

❑ **Maintenance**

- Console Settings
- Ping
- Firmware Upgrade
- Config Import Export
- Load Factory Default
- Username/Password
- Locate Device
- Misc. Settings

❑ **Save Configuration**

❑ **Restart**

❑ **Logout**

Web Browser Configuration

Moxa WAC-1001's web browser interface provides a convenient way to modify its configuration and access the built-in monitoring and network administration functions. The recommended web browser is Microsoft® Internet Explorer 7.0 or 8.0 with JVM (Java Virtual Machine) installed.

NOTE To use the WAC-1001's management and monitoring functions from a PC host connected to the same LAN as the WAC-1001, you must make sure that the PC host and the WAC-1001 are on the same logical subnet. The Moxa WAC-1001's default IP is **192.168.127.253**.

Follow these steps to access the WAC-1001's web-based console management interface.

1. Open your web browser (e.g., Internet Explorer) and type the WAC-1001's IP address in the address field. Press **Enter** to establish the connection.

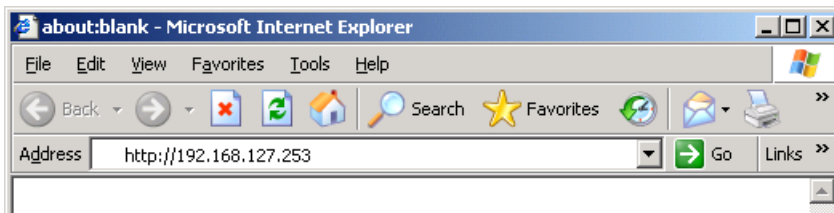

2. The Web Console Login page will open. Enter the password (default Username = **admin**; default Password = **root**) and then click **Login** to continue.

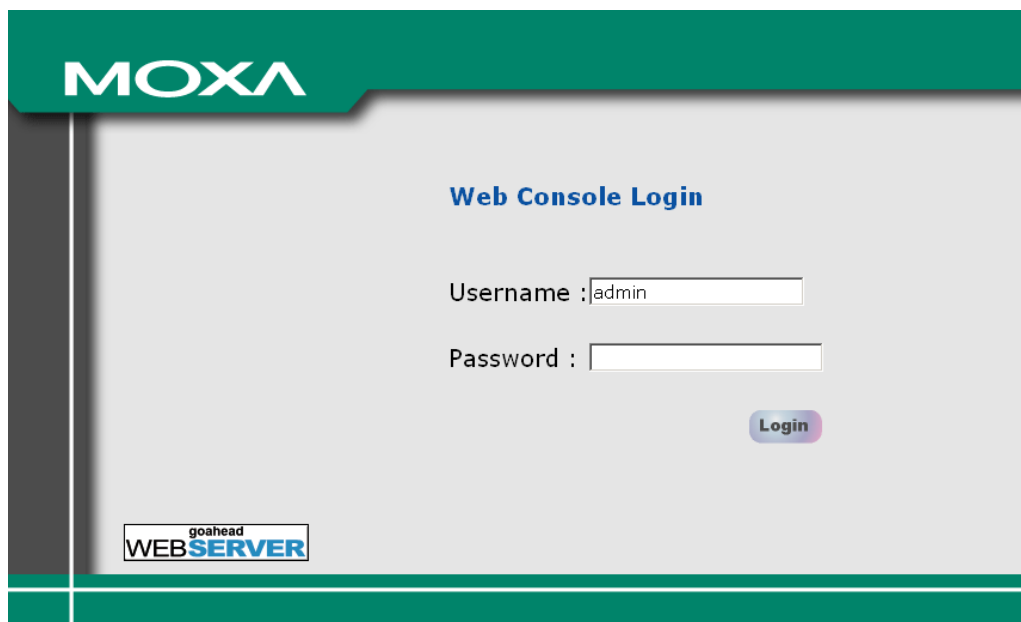

3. You may need to wait a few moments for the web page to download to your computer. Note that the Model name and IP address of your WAC-1001 are both shown in the title bar of the web page. This information can be used to help you identify multiple WAC-1001 units.

- Use the menu tree on the left side of the window to open the function pages to access each of the WAC-1001's functions.

The screenshot shows the MOXA web console interface. The top header features the MOXA logo and the website URL www.moxa.com. On the left, a menu tree is visible with the following items: Main Menu, Overview, Basic Settings (containing System Info Settings, Network Settings, and Time Settings), Controller Settings (highlighted with a dashed box), Basic WAC Settings, WLAN Security Settings, Advanced Settings, Auto Warning Settings, Status, Maintenance, Save Configuration, Restart, and Logout. The main content area is titled 'Overview' and contains the text: 'All information on this page are active values.' Below this, there are three sections of information presented in table-like formats:

System info	
Model name	WAC-1001
Device name	WAC-1001_8357
Serial No.	8357
System up time	0 days 00h:34m:41s
Firmware version	1.0 Build 10120321

Device info	
Device MAC address	00:90:E8:22:9B:AE
IP address	192.168.127.253
Subnet mask	255.255.255.0
Gateway	

Controller info	
Roaming method	Compare
Roaming domain	FF:90:E8:22:9B:AE

In the following paragraphs, we describe each WAC-1001 management function in detail. A quick overview is available in this manual in the "Function Map" section of Chapter 2.

NOTE For security reasons, you will need to log back into the WAC-1001 after a 5-minute time-out.

Overview

The **Overview** page summarizes the WAC-1001's current status. The information is categorized into several groups: **System info**, **Device info**, and **Controller info**.

Overview	
All information on this page are active values.	
System info	
Model name	WAC-1001
Device name	WAC-1001_4782
Serial No.	4782
System up time	0 days 00h:13m:00s
Firmware version	1.5 Build 15050613
Device info	
Device MAC address	00:90:E8:38:29:EE
IP address	192.168.127.253
Subnet mask	255.255.255.0
Gateway	
Controller info	
Roaming domain	Not setting
WAC group multicast IP	239.0.1.150
WAC mode	Primary WAC
Backup WAC IP address	
Priority 1 roaming threshold	-75 (-100 to -35 dBm)
Priority 1 roaming difference	0 (0 to 30 dB)
Priority 1 roaming link quality	30 / 70
Priority 2 roaming threshold	-55 (-100 to -35 dBm)
Priority 2 roaming difference	10 (0 to 30 dB)
Priority 2 roaming link quality	20 / 70
Roaming stable interval	3 *50 ms

Basic Settings

The Basic Settings group includes the most commonly used settings required by administrators to maintain and control the WAC-1001.

System Info Settings

The **System Info** items, especially **Device name** and **Device description**, are displayed and included on the **Overview** page, in SNMP information, and in alarm emails. Setting **System Info** items makes it easier to identify the different WAC-1001 units connected to your network.

System Info Settings	
Device name	<input type="text" value="WAC-1001_0049"/>
Device location	<input type="text" value="Area 32, 5th Floor"/>
Device description	<input type="text" value="No. 11 of ABC supporting system"/>
Device contact information	<input type="text" value="John Davis, sysop@abc.com"/>

Device name

Setting	Description	Factory Default
Max. 31 of characters	This option is useful for specifying the role or application of different WAC-1001 units.	WAC-1001_<Serial No. of this WAC-1001>

Device location

Setting	Description	Factory Default
Max. of 31 characters	Specifies the location of different WAC-1001 units.	None

Device description

Setting	Description	Factory Default
Max. of 31 characters	Use this space to record a more detailed description of the WAC-1001	None

Device contact information

Setting	Description	Factory Default
Max. of 31 characters	Provides information about whom to contact in order to resolve problems. Use this space to record contact information of the person responsible for maintaining this WAC-1001.	None

Network Settings

The Network Settings configuration panel allows you to modify the usual TCP/IP network parameters. An explanation of each configuration item is given below.

Network Settings

IP configuration: (Dropdown menu with options: Static, DHCP, Static)

IP address:

Subnet mask:

Gateway:

Primary DNS server:

Secondary DNS server:

IP configuration

Setting	Description	Factory Default
DHCP	The WAC-1001's IP address will be assigned automatically by the network's DHCP server	Static
Static	Set up the WAC-1001's IP address manually.	

IP address

Setting	Description	Factory Default
WAC-1001's IP address	Identifies the WAC-1001 on a TCP/IP network.	192.168.127.253

Subnet mask

Setting	Description	Factory Default
WAC-1001's subnet mask	Identifies the type of network to which the WAC-1001 is connected (e.g., 255.255.0.0 for a Class B network, or 255.255.255.0 for a Class C network).	255.255.255.0

Gateway

Setting	Description	Factory Default
WAC-1001's default gateway	The IP address of the router that connects the LAN to an outside network.	None

Primary/ Secondary DNS server

Setting	Description	Factory Default
IP address of the Primary/Secondary DNS server	The IP address of the DNS Server used by your network. After entering the DNS Server's IP address, you can input the WAC-1001's URL (e.g., http://ap11.abc.com) in your browser's address field instead of entering the IP address. The Secondary DNS server will be used if the Primary DNS server fails to connect.	None

Time Settings

The WAC-1001 has a time calibration function based on information from an NTP server or user specified Date and Time information. Functions such as Auto warning can add real-time information to the message.

Time Settings

Current local time

Date (YYYY/MM/DD)
Time (HH:MM:SS)

1999 /
 11 /
 30
00 :
 01 :
 54

Time protocol

Time zone

Daylight saving time

Enable

Starts at : (HH:MM)

Stops at : (HH:MM)

Time offset

Time server 1

Time server 2

Query period (600~9999 seconds)

The **Current local time** shows the WAC-1001's system time when you open this web page. You can click on the **Set Time** button to activate the updated date and time parameters. An "(Updated)" string will appear to indicate that the change is complete. Local time settings will be immediately activated in the system without running Save and Restart.

NOTE The WAC-1001 has a built-in real time clock (RTC). We strongly recommend that users update the **Local time** for the WAC-1001 after the initial setup or a long-term shutdown, especially when the network does not have an Internet connection for accessing the NTP server or there is no NTP server on the LAN.

Current local time

Setting	Description	Factory Default
User adjustable time	The date and time parameters allow configuration of the local time, with immediate activation. <i>Use 24-hour format: yyyy/mm/dd hh:mm:ss</i>	None

Time protocol

Setting	Description	Factory Default
SNTP	Selects SNTP server functionality for clients	SNTP
NTP	Selects NTP server functionality for clients	

Time zone

Setting	Description	Factory Default
User selectable time zone	The time zone setting allows conversion from GMT (Greenwich Mean Time) to local time.	GMT (Greenwich Mean Time)



ATTENTION

Because the **current local time** will be adjusted automatically as the **time zone** is being adjusted, you will need to configure the **time zone** prior to inputting the **current local time**.

Daylight saving time

Setting	Description	Factory Default
Enable/ Disable	Daylight saving time (also known as DST or summer time) involves advancing clocks (usually 1 hour) during the summer time to provide an extra hour of daylight in the afternoon.	Disable

When **Daylight saving time** is enabled, the following parameters will be shown:

- **Starts at:** The date that daylight saving time begins.
- **Stops at:** The date that daylight saving time ends.
- **Time offset:** Indicates how many hours forward the clock should be advanced.

Time server 1/2

Setting	Description	Factory Default
IP/Name of Time Server 1/2	IP or Domain name of the NTP time server. The 2nd NTP server will be used if the 1st NTP server fails to connect.	None

Query period

Setting	Description	Factory Default
Query period time (1 to 9999 seconds)	This parameter determines how often the time is updated from the NTP server.	600 (seconds)

Controller Settings

The Controller Settings group includes the most important settings, which enable administrators to set up the WAC-1001's services.

Basic WAC Settings

The **Roaming method** and the **Roaming domain's** information are displayed on the **Overview** page.

Note: Using the **Roaming method** requires the input of different parameters. See below for details.

Roaming method: Compare

Basic WAC Settings

Inter WAC enable

WAC group ID

WAC passphrase

WAC group multicast IP

WAC mode

Backup WAC IP address

Roaming domain

Priority 1 roaming threshold (-100 to -35 dBm)

Priority 1 roaming difference (0 to 30 dB)

Priority 1 roaming link quality / 70

Priority 2 roaming threshold (-100 to -35 dBm)

Priority 2 roaming difference (0 to 30 dB)

Priority 2 roaming link quality / 70

Roaming stable interval *50 ms

The tables below describe the **Roaming method** and **Roaming domain's** parameters and options. Alternatively, you may refer to Appendix A.

Inter WAC enable

Setting	Description	Factory Default
Enable/Disable	Enable or disable the Inter WAC feature	Enable

WAC group ID

Setting	Description	Factory Default
Max. of 31 characters	The group ID for WACs to recognize each other as a member of the same WAC community, so that the inter-WAC feature will operate properly	Moxa

WAC passphrase

Setting	Description	Factory Default
Max. of 63 characters (masked)	The passphrase for inter WAC security and to prevent rouge WACs	None

WAC group multicast IP

Setting	Description	Factory Default
Multicast IP	The multicast IP address for inter-WAC communication	239.0.1.150

WAC mode

Setting	Description	Factory Default
Primary WAC	Act as a primary WAC	Primary WAC
Backup WAC	Act as a backup WAC	

Primary/Backup WAC IP address

Setting	Description	Factory Default
IP address	The IP address of the pairing controller; when one fails, another controller will take over its network function within 500 ms	None

Roaming domain

Setting	Description	Factory Default
6 Hex characters	Specifies the area served by the WAC-1001. All related controllers, APs, and clients use this as identification to work and communicate with each other.	<The Mac address of the WAC-1001>

Priority 1/2 roaming threshold

Setting	Description	Factory Default
Signal strength (dBm)	The signal strength of the current AP and Client must be lower than this threshold.	Priority 1: -75 Priority 2: -55

Priority 1/2 roaming difference

Setting	Description	Factory Default
Relative value (dB)	The signal strength between the target AP and Client must be greater than this value	Priority 1: 0 Priority 2: 10

Priority 1/2 roaming link quality

Setting	Description	Factory Default
Link quality (Integer)	The link quality (signal strength – Background noise) between the target AP and Client must be greater than this threshold.	Priority 1: 30 Priority 2: 20

Roaming stable interval

Setting	Description	Factory Default
Multiple of 50 ms (Integer)	The above three conditions must stay true for X amount of time to ensure a stable state.	3 (x 50 ms)

WLAN Security Settings

By enabling the 802.11X, you can use the Extensible Authentication Protocol (EAP), a framework authentication protocol used by 802.1X, to provide network authentication. Such enterprise-level security modes require a back-end Remote Authentication Dial-In User Service (RADIUS) server if IEEE 802.1X functionality is enabled in WPA/WPA2. The IEEE 802.1X protocol also provides the ability possibility to carry out efficient connection authentication for a large-scale network. It is not necessary to exchange keys or passphrases.

When you enable EAP, the WPA/WPA2-enterprise wireless security functions of the managed APs will be disabled. The WAC-1001 will then act as an EAP proxy or relay to support WAP/WPA2-enterprise wireless security.

WLAN Security Settings

RADIUS proxy settings

802.1X/ EAP

Primary RADIUS server IP

Primary RADIUS server port

Primary RADIUS shared key

Secondary RADIUS server IP

Secondary RADIUS server port

Secondary RADIUS shared key

802.1X/ EAP

Setting	Description	Factory Default
Enable/Disable	Enables EAP proxy/relay support. The wireless security functions of the managed APs will be disabled.	Disable

Primary/ Secondary RADIUS server IP

Setting	Description	Factory Default
The IP address of the RADIUS server	Specifies the delegated RADIUS server for EAP	None

Primary/ Secondary RADIUS server port

Setting	Description	Factory Default
Port number	Specifies the port number of the delegated RADIUS server	1812

Primary/ Secondary RADIUS shared key

Setting	Description	Factory Default
Max. 31 characters	The secret key shared between the AP and RADIUS server	None

NOTE The wireless security settings of all the APs that are deployed in the same **roaming domain** must be consistent and homogeneous. Different security settings in same-grouped APs may cause **Turbo Roaming** failures. Refer to the AWK-3121/4121-RS manual for detailed information about the Wireless Setting.

Advanced Settings

SNMP Agent

The WAC-1001 supports SNMP V1/V2c/V3. SNMP V1 and SNMP V2c use a community string match for authentication, which means that SNMP servers access all objects with read-only or read/write permissions using the community string *public/private* (default value). SNMP V3, which requires you to select an authentication level of MD5 or SHA, is the most secure protocol. You can also enable data encryption to enhance data security.

The WAC-1001's MIB can be found in the software CD and supports reading the attributes via SNMP. (Only *get* method is supported.)

SNMP security modes and security levels supported by the WAC-1001 are shown in the following table. Select the security mode and level that will be used to communicate between the SNMP agent and manager.

Protocol Version	Setting on UI web page	Authentication Type	Data Encryption	Method
SNMP V1, V2c	V1, V2c Read Community	Community string	No	Use a community string match for authentication
	V1, V2c Write/Read Community	Community string	No	Use a community string match for authentication
SNMP V3	No-Auth	No	No	Use account with admin or user to access objects
	MD5 or SHA	Authentication based on MD5 or SHA	No	Provides authentication based on HMAC-MD5, or HMAC-SHA algorithms. 8-character passwords are the minimum requirement for authentication.
	MD5 or SHA	Authentication based on MD5 or SHA	Data encryption key	Provides authentication based on HMAC-MD5 or HMAC-SHA algorithms, and data encryption key. 8-character passwords and a data encryption key are the minimum requirements for authentication and encryption.

The following parameters can be configured on the **SNMP Agent** page. A more detailed explanation of each parameter is given below the following figure.

SNMP Agent

Enable Disable ▾

Read community

Write community

SNMP agent version V1, V2c ▾

Admin auth type No Auth ▾

Admin privacy key Disable ▾

Privacy key

Private MIB information

Device object ID enterprise.8691.15.1

Enable

Setting	Description	Factory Default
Enable	Enables SNMP Agent	Disable
Disable	Disables SNMP Agent	

Read community (for V1, V2c)

Setting	Description	Factory Default
V1, V2c Read Community	Use a community string match with a maximum of 31 characters for authentication. This means that the SNMP agent can access all objects with read-only permissions using this community string.	public

Write community (for V1, V2c)

Setting	Description	Factory Default
V1, V2c Read /Write Community	Use a community string match with a maximum of 31 characters for authentication. This means that the SNMP agent can access all objects with read/write permissions using this community string.	private

SNMP agent version

Setting	Description	Factory Default
V1, V2c, V3, or V1, V2c, or V3 only	Select the SNMP protocol version used to manage the switch.	V1, V2c

Admin auth type (for V1, V2c, V3, and V3 only)

Setting	Description	Factory Default
No Auth	Use admin account to access objects. No authentication	No Auth
MD5	Provide authentication based on the HMAC-MD5 algorithms. 8-character passwords are the minimum requirement for authentication.	
SHA	Provides authentication based on HMAC-SHA algorithms. 8-character passwords are the minimum requirement for authentication.	

Admin private key (for V1, V2c, V3, and V3 only)

Setting	Description	Factory Default
Disable	No data encryption	Disable
DES	DES-based data encryption	
AES	AES-based data encryption	

Private Key

A data encryption key is the minimum requirement for data encryption (maximum of 63 characters)

Private MIB Information Device Object ID

Also known as **OID**. This is the WAC-1001's enterprise value. It is fixed.

Auto Warning Settings

Since industrial-grade devices are often located at the endpoints of a system, these devices will not always know what is happening elsewhere on the network. This means that these devices, including wireless APs or clients, must provide system maintainers with real-time alarm messages. Even when system administrators are out of the control room for an extended period, they can still be informed of the status of devices almost instantaneously when exceptions occur.

In addition to logging these events, the WAC-1001 supports different approaches to warn engineers automatically, such as SNMP trap, e-mail, and relay output. It also supports two digital inputs to integrate sensors into your system to automate alarms by email and relay output.

System Log

System Log Event Types

Detail information for grouped events is shown in the following table. You can check the box for **Enable log** to enable the grouped events. All default values are enabled (checked). The log for system events can be seen in **Status → System Log**.

System Log Event Types	
Event Group	Enable Log
System-related events	<input checked="" type="checkbox"/>
Network-related events	<input checked="" type="checkbox"/>
Config-related events	<input checked="" type="checkbox"/>
Power events	<input checked="" type="checkbox"/>
DI events	<input checked="" type="checkbox"/>
Controller-related events	<input type="checkbox"/>

System-related events	Event is triggered when...
System restart (warm start)	The WAC-1001 is rebooted, such as when its settings are changed (IP address, subnet mask, etc.).
Network-related events	Event is triggered when...
LAN link on	The LAN port is connected to a device or network.
LAN link off	The port is disconnected (e.g., the cable is pulled out, or the opposing device shuts down).
Config-related events	Event is triggered when...
Configuration Changed	A configuration item has been changed.
Configuration file import via Web Console	The configuration file is imported to the WAC-1001.
Console authentication failure	An incorrect password is entered.
Firmware upgraded	The WAC-1001's firmware is updated.
Power events	Event is triggered when...
Power 1/2 transition (On -> Off)	The WAC-1001 is powered down in PWR1/2.
PoE transition (On -> Off)	The WAC-1001 is powered down in PoE.
Power 1/2 transition (Off -> On)	The WAC-1001 is powered via PWR1/2.
PoE transition (Off -> On)	The WAC-1001 is powered via PoE.
DI events	Event is triggered when...
DI1/2 transition (On -> Off)	Digital Input 1/2 is triggered by on to off transition
DI1/2 transition (Off -> On)	Digital Input 1/2 is triggered by off to on transition
Controller-related events	Event is triggered when...
CPU status	CPU over-temperature or overload
AP status	AP joined/left
STA status	Client joined/left
Controller status	Primary/Backup WAC up/down, Inter WAC joined/left
Roaming status	Client roaming

Syslog

This function provides the event logs for the Syslog server. The function supports up to three configurable Syslog servers and Syslog server UDP port numbers. When an event occurs, the event will be sent as a Syslog UDP packet to the specified Syslog servers.

Syslog Event Types

Detail information for the grouped events is shown in the following table. You can check the box for **Enable log** to enable the grouped events. All default values are enabled (checked). Details for each event group can be found on the "System log Event Types" table.

Syslog Event Types	
Event Group	Enable Log
System-related events	<input checked="" type="checkbox"/>
Network-related events	<input checked="" type="checkbox"/>
Config-related events	<input checked="" type="checkbox"/>
Power events	<input checked="" type="checkbox"/>
DI events	<input checked="" type="checkbox"/>
Controller-related events	<input type="checkbox"/>
RSSI report events	<input type="checkbox"/>

RSSI report events	Event is triggered when...
RSSI between governed Client and its monitor-APs.	Continuously reports the RSSI value between the governed Client and its monitor-APs. This report is used by "Moxa RSSI Transformer" to assist with site surveying and system setup.

Syslog Server Settings

You can configure the parameters for your Syslog servers in this page.

Syslog Server Settings	
Syslog server 1	<input type="text"/>
Syslog port	<input type="text" value="514"/>
Syslog server 2	<input type="text"/>
Syslog port	<input type="text" value="514"/>
Syslog server 3	<input type="text"/>
Syslog port	<input type="text" value="514"/>

Syslog server 1/ 2/ 3

Setting	Description	Factory Default
IP address	Enter the IP address of the 1st/ 2nd/ 3rd Syslog Server	None

Syslog port

Setting	Description	Factory Default
Port destination (1 to 65535)	Enter the UDP port of the corresponding Syslog server	514

E-mail

E-mail Event Types

Check the box for **Active** to enable the event items. All default values are deactivated (unchecked). Details for each event item can be found on the "System log Event Types" table.

E-mail Event Types	
Event	<input type="checkbox"/> Active
Cold start	<input type="checkbox"/>
Warm start	<input type="checkbox"/>
Power 1 transition (On-->Off)	<input type="checkbox"/>
Power 1 transition (Off-->On)	<input type="checkbox"/>
Power 2 transition (On-->Off)	<input type="checkbox"/>
Power 2 transition (Off-->On)	<input type="checkbox"/>
PoE transition (On-->Off)	<input type="checkbox"/>
PoE transition (Off-->On)	<input type="checkbox"/>
Configuration changed	<input type="checkbox"/>
Console authentication failure	<input type="checkbox"/>
DI 1 transition (On-->Off)	<input type="checkbox"/>
DI 1 transition (Off-->On)	<input type="checkbox"/>
DI 2 transition (On-->Off)	<input type="checkbox"/>
DI 2 transition (Off-->On)	<input type="checkbox"/>
LAN link on	<input type="checkbox"/>
LAN link off	<input type="checkbox"/>
CPU status	<input type="checkbox"/>
AP status	<input type="checkbox"/>
STA status	<input type="checkbox"/>
Controller Status	<input type="checkbox"/>

E-mail Server Settings

You can set up to 4 e-mail addresses to receive alarm emails from the WAC-1001. The following parameters can be configured on the **E-mail Server Settings** page. In addition, a **Send Test Mail** button can be used to test whether the Mail server and e-mail addresses work well. More detailed explanations about these parameters are given after the following figure.

E-mail Server Settings

Mail server (SMTP)

User name

Password

From e-mail address

To e-mail address 1

To e-mail address 2

To e-mail address 3

To e-mail address 4

Mail server (SMTP)

Setting	Description	Factory Default
IP address	The IP Address of your email server.	None

User name & Password

Setting	Description	Factory Default
	User name and password used in the SMTP server	None

From e-mail address

Setting	Description	Factory Default
Max. 63 characters	Enter the administrator's e-mail address which will be shown in the "From" field of a warning e-mail.	None

To E-mail address 1/ 2/ 3/ 4

Setting	Description	Factory Default
Max. 63 characters	Enter the receivers' e-mail addresses.	None

Relay

The WAC-1001 has one relay output, which consists of 2 terminal block contacts on the WAC-1001's top panel. These relay contacts are used to indicate user-configured events and system failure.

The two wires attached to the relay contacts form an open circuit when a user-configured event is triggered. If a user-configured event does not occur, the relay circuit will remain closed. For safety reasons, the relay circuit is kept open when the WAC-1001 is not powered.

Relay Event Types

You can check the box for **Active** to enable the event items. All default values are deactivated (unchecked). Details for each event item can be found in the "System log Event Types" table on page 3-31.

Relay Event Types	
Event	Active
Power 1 transition (On-->Off)	<input type="checkbox"/>
Power 2 transition (On-->Off)	<input type="checkbox"/>
PoE transition (On-->Off)	<input type="checkbox"/>
DI 1 transition (On-->Off)	<input type="checkbox"/>
DI 1 transition (Off-->On)	<input type="checkbox"/>
DI 2 transition (On-->Off)	<input type="checkbox"/>
DI 2 transition (Off-->On)	<input type="checkbox"/>
LAN link On	<input type="checkbox"/>
LAN link Off	<input type="checkbox"/>

Trap

Traps can be used to signal abnormal conditions (notifications) to a management station. This trap-driven notification can make your network more efficient.

Because a management station usually takes care of a large number of devices that have a large number of objects, it will be overloading for the management station to poll or send requests to query every object on every device. It would be better if the managed device agent could notify the management station by sending a message known as a trap for the event.

Trap Event Types

Trap Event Types	
Event	<input type="checkbox"/> Active
Cold start	<input type="checkbox"/>
Warm start	<input type="checkbox"/>
Power 1 transition (On-->Off)	<input type="checkbox"/>
Power 1 transition (Off-->On)	<input type="checkbox"/>
Power 2 transition (On-->Off)	<input type="checkbox"/>
Power 2 transition (Off-->On)	<input type="checkbox"/>
PoE transition (On-->Off)	<input type="checkbox"/>
PoE transition (Off-->On)	<input type="checkbox"/>
Configuration changed	<input type="checkbox"/>
Console authentication failure	<input type="checkbox"/>
DI 1 transition (On-->Off)	<input type="checkbox"/>
DI 1 transition (Off-->On)	<input type="checkbox"/>
DI 2 transition (On-->Off)	<input type="checkbox"/>
DI 2 transition (Off-->On)	<input type="checkbox"/>
LAN link on	<input type="checkbox"/>
LAN link off	<input type="checkbox"/>
CPU status	<input type="checkbox"/>
AP status	<input type="checkbox"/>
STA status	<input type="checkbox"/>
Controller Status	<input type="checkbox"/>

SNMP Trap Receiver Settings

SNMP traps are defined in SMIV1 MIBs (SNMPv1) and SMIV2 MIBs (SNMPv2c). The two styles are basically equivalent, and it is possible to convert between the two. You can set the parameters for SNMP trap receivers from the web page.

SNMP Trap Receiver Settings	
SNMP alert type	Trap ▾
1st Trap version	V1 ▾
1st Trap server IP/name	<input type="text"/>
1st Trap community	alert <input type="text"/>
2nd Trap version	V1 ▾
2nd Trap server IP/name	<input type="text"/>
2nd Trap community	alert <input type="text"/>
3rd Trap version	V1 ▾
3rd Trap server IP/name	<input type="text"/>
3rd Trap community	alert <input type="text"/>

SNMP alert type

Setting	Description	Factory Default
Trap	Send the event notification to the Trap Receiver once, and only once	Trap
Inform	Send the event notification to the Trap Receiver and expect an acknowledgement. If the acknowledgement is not received, the controller will resend the notification	

1st / 2nd Trap version

Setting	Description	Factory Default
V1	SNMP trap defined in SNMPv1	V1
V2	SNMP trap defined in SNMPv2	

1st / 2nd Trap server IP/name

Setting	Description	Factory Default
IP address or host name	Enter the IP address or name of the trap server used by your network.	None

1st / 2nd Trap community

Setting	Description	Factory Default
Max. of 31 characters	Use a community string match with a maximum of 31 characters for authentication.	alert

Status

System Log

Triggered events are recorded in System Log. You can export the log contents to an available viewer by clicking **Export Log**. You can use the **Clear Log** button to clear the log contents and the **Refresh** button to refresh the log.

System Log

```
( 116) 2010/06/18,20h:46m:50s Power 1 transition (Off -> On)
( 117) 2010/06/18,20h:46m:50s LAN link on
( 118) 2010/06/18,21h:17m:01s System restart
( 119) 2010/06/18,21h:17m:10s Power 1 transition (Off -> On)
( 120) 2010/06/18,21h:17m:10s LAN link on
( 121) 2010/06/18,21h:19m:55s System restart
( 122) 2010/06/18,21h:20m:04s Power 1 transition (Off -> On)
( 123) 2010/06/18,21h:20m:04s LAN link on
( 124) 2010/06/18,21h:26m:05s System restart
( 125) 2010/06/18,21h:26m:14s Power 1 transition (Off -> On)
( 126) 2010/06/18,21h:26m:14s LAN link on
```

▲

▼

Export Log Clear Log Refresh

Relay Status

The status of user-configurable events can be found under **Relay Status**. The status will refresh every 5 seconds if the **Auto refresh** box is checked.

If an event is triggered, it will be noted on this list. System administrators can click **Acknowledge Event** when he has acknowledged the event and addressed it.

Relay Status

Auto refresh

Relay Status		
Power1 transition (On-->Off)	---	Acknowledge Event
Power2 transition (On-->Off)	---	Acknowledge Event
PoE transition (On-->Off)	---	Acknowledge Event
DI1 transition (On-->Off)	---	Acknowledge Event
DI1 transition (Off-->On)	---	Acknowledge Event
DI2 transition (On-->Off)	---	Acknowledge Event
DI2 transition (Off-->On)	---	Acknowledge Event
LAN link On	---	Acknowledge Event
LAN link Off	---	Acknowledge Event

DI and Power Status

The status of power inputs and digital inputs is shown on this web page. The status will refresh every 5 seconds if the **Auto refresh** box is checked.

DI and Power Status

Auto refresh

Input status	On / Off
Power 1 status	On
Power 2 status	Off
PoE status	Off
DI 1 status	Off
DI 2 status	Off

Managed Device List

The **Managed Device List** displays all AWK APs, which are managed by the WAC-1001; the associated clients are also displayed here. Select the **Auto refresh check box** to enable periodic updates.

Managed Device List

Auto refresh

Refresh timer 3

Number of managed AP(s) 2

Number of managed client(s) 1

AP					Client				
IP	MAC	Channel	Noise Level (dBm)	Status	IP	MAC	RSSI (dB)	Signal Strength (dBm)	Status
172.28.2.1	06:90:E8:00:03:DE	1	-96	On	N/A	N/A	N/A	N/A	N/A
172.28.0.1	06:90:E8:00:03:DF	1	-96	On	172.26.0.1	00:90:E8:17:1A:A1	63	-33	On

NOTE The WAC-1001 manages only the AWK-RTG devices to ensure fast roaming performance. All other devices on the network (such as routers/gateways/servers) and their performance cannot be managed by the WAC-1001.

LAN Status

The LAN Status displays the status of Ethernet port.

LAN Status					
<input checked="" type="checkbox"/> Auto refresh					
LAN No	Speed	Duplex	Link Status/Admin Down	Tx Packets	Rx Packets
LAN 1	100M	FULL	ON/N	1550	2149

Maintenance

Maintenance functions provide the administrator with tools to manage the WAC-1001 and wired/wireless networks.

Console Settings

You can enable or disable access permission for the following consoles: HTTP, HTTPS, Telnet and SSH connections. For more security, we recommend you only allow access to the two secured consoles, HTTPS and SSH.

Console Settings

HTTP console Enable Disable
HTTPS console Enable Disable
Telnet console Enable Disable
SSH console Enable Disable

Ping

Ping helps to diagnose the integrity of wired or wireless networks. By inputting a node's IP address in the **Destination** field, you can use the **ping** command to make sure it exists and whether or not the access path is available.

Ping

Destination

If the node and access path are available, you will see that all packets were successfully transmitted with no loss. Otherwise, some, or even all, packets may get lost, as shown in the following figure.

Ping

Destination

PING 192.168.127.2 (192.168.127.2): 56 data bytes

--- 192.168.127.2 ping statistics ---

4 packets transmitted, 0 packets received, 100% packet loss

Firmware Upgrade

The WAC-1001 can be enhanced with more value-added functions by installing firmware upgrades. The latest firmware is available at Moxa's website (<http://www.moxa.com>).

Note that while the firmware is being upgraded, all APs controlled by the WAC-1001 will be out of service. Click the **Browse** button to specify the firmware image file and click **Firmware Upgrade and Restart** to start the firmware upgrade. After the progress bar reaches 100%, the WAC-1001 will reboot itself.

When upgrading your firmware, the WAC-1001's other functions are forbidden.

Firmware Upgrade

Select update image



ATTENTION

Please make sure the power source is stable when you upgrade your firmware. An unexpected power breakup may damage your WAC-1001.

Config Import Export

You can back up or restore the WAC-1001's configuration with **Config Import Export**.

Config Import Export

Config Import

Select configuration file

Config Export

In the **Config Import** section, click **Browse** to specify the configuration file and click the **Config Import** button to begin importing the configuration.

In the **Config Export** section, click the **Config Export** button and save the configuration file onto your local storage media. The configuration file is a text file; you can view and edit it with a general text-editing tool.

You can also backup or restore the WAC-1001's configuration via **TFTP**.

TFTP Import

TFTP server IP

Configuration path

File name

TFTP Export

TFTP server IP

Setting	Description	Factory Default
IP address	The IP address of the TFTP server	None

Configuration path

Setting	Description	Factory Default
File system characters (a-z, A-Z, 0-9, etc.)	The relative path to the configuration file on the TFTP server	None

File name

Setting	Description	Factory Default
File system characters (a-z, A-Z, 0-9, etc...)	The file name of the configuration file	None

In the **Config Import** section, click the **Config Import** button to begin importing the configuration.

In the **Config Export** section, click the **Config Export** button; the configuration file will be saved to the specified TFTP server as **importTFTP.ini**.

You can also back up or restore the ABC-01 (supported HW Rev. 1.1 only) configuration with **Config Import Export**.



To download the configuration to the AWK:

1. Turn off the AWK.
2. Plug in the ABC-01 to the AWK's RS-232 console.
3. Turn on the AWK.
4. The AWK will detect the ABC-01 during bootup, and download the configuration from the ABC-01 to the AWK automatically. Once the configuration downloads and if configuration format is correct, the AWK will emit three short beeps, and then continue the boot up.
5. Once the AWK has booted up successfully, it will emit the normal two beeps, and the ready LED will turn to solid green.

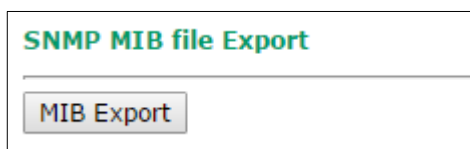

Click MIB Export to save a MIB file to your local storage. The configuration file is a .my file that you can import with a general SNMP tool. This operation allows you to control or configure the WAC-1001 remotely.

Load Factory Default

Use this function to reset the WAC-1001 and roll all settings back to the factory default values. You can also reset the hardware by pressing the reset button on the top panel of the WAC-1001.

Load Factory Default

Reset to Factory Default

Click **Activate** to reset all settings, including the console password, to the factory default values.

The system will restart momentarily.

Username/Password

You can change the administration username/password for each of the WAC-1001's console managers by using the **Username/Password** function. Before you set up a new password, you must input the current password and reenter the new password for confirmation. For your security, do not use the default password **root**, and remember to change the administration password regularly.

Username/Password

Username

Current password

New password

Confirm password

Locate Device

This function helps you easily find your device. When you click "Start to locate" button, the device's beeper will emit a beeping sound, and the LED will blink on and off.

Locate Device (Beeper & LED)

Status: Ready to locate

After you find your device, click "Stop locating" to stop the beeper and blinking of the LED.

Locate Device (Beeper & LED)

Status: Locating...

Misc. Settings

Additional settings to help you manage your WAC-1001, are available on this page.

Misc. Settings

Reset button Always enable Always disable Disable 'restore to default function' after 60 sec

Reset button

Setting	Description	Factory Default
Always enable	The WAC-1001's Reset button works normally.	Always enable
Always disable	The WAC-1001's function of Reset button will be disabled.	
Disable 'restore to default function' after 60 sec	The WAC-1001's reset to default function will be inactive 60 seconds after the WAC-1001 finishes booting up.	

Save Configuration

The following figure shows how the WAC-1001 stores the setting changes into volatile and non-volatile memory. All data stored in volatile memory will disappear when the WAC-1001 is shutdown or rebooted unless they are saved onto the flash (non-volatile) memory. Because the WAC-1001 starts up and initializes with the settings stored in flash memory, all new changes must be saved to flash memory before restarting the WAC-1001.

This also means the new changes will not work unless you run either the **Save Configuration** function or the **Restart** function.

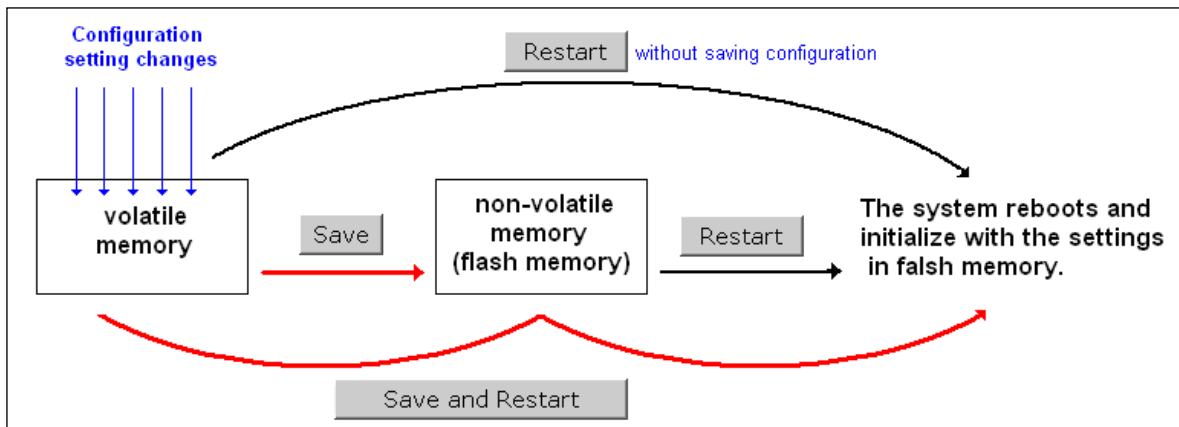

After you click on **Save Configuration** in the left menu box, the following screen will appear. Click **Save** if you wish to update the configuration settings in the flash memory at this time. Alternatively, you may choose to run other functions and put off saving the configuration until later. However, the new setting changes will remain in the non-volatile memory until you save the configurations.

Save Configuration

If you have made configuration changes, you must save the changes and then restart the system to activate the changes. Click **Save** to save the changes to the WAC-1001's memory. Remember to click **Restart** to activate the changes.

Restart

If you submitted configuration changes, you will see a blinking alert message on the upper right corner of the screen. After making all your changes, click the **Restart** function in the left menu box. One of two different screens will appear.

If you made changes recently but did not save, you will be given two options. Clicking the **Restart** button here will reboot the WAC-1001, and all setting changes will be ignored. Clicking the **Save and Restart** button will apply all setting changes and then reboot the WAC-1001.

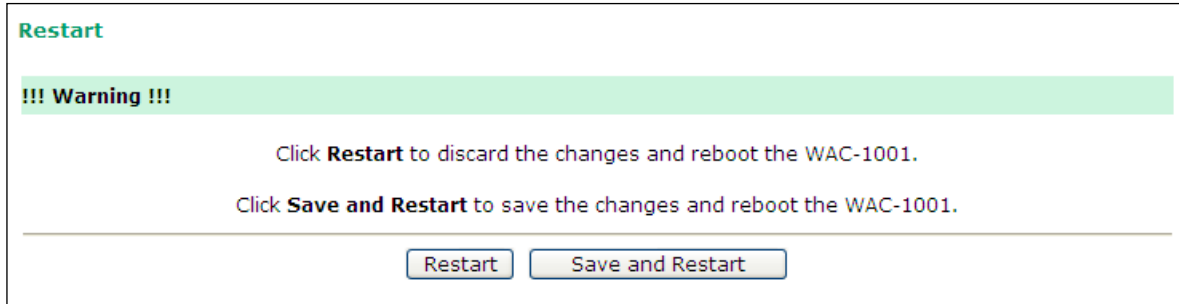

If you run the **Restart** function without changing any configurations or saving all your changes, you will see just one **Restart** button on your screen.

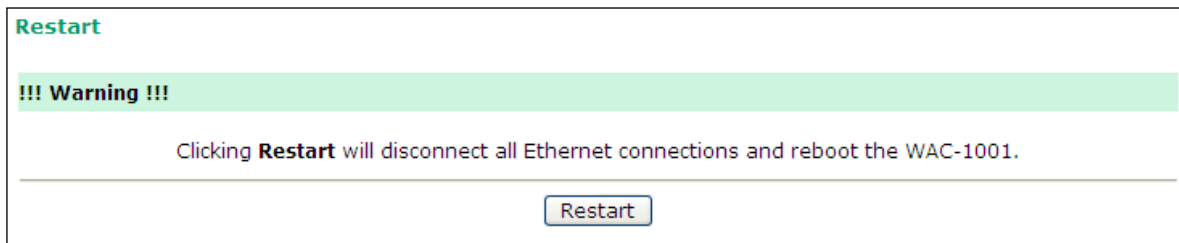

You will not be able to run any of the WAC-1001's functions while the system is rebooting.

Logout

Logout helps users disconnect the current HTTP or HTTPS session and go to the Login page. For security reasons, we recommend you logout before quitting the console manager.

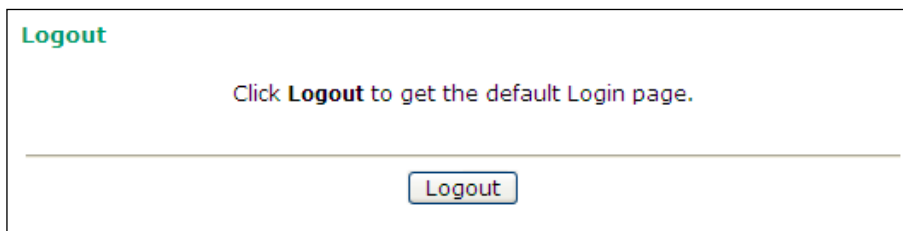

Software Installation and Configuration

The following topics are covered in this chapter:

- **Overview**
- **AWK Search Utility**
 - Installing AWK Search Utility
 - Configuring AWK Search Utility

Overview

The Documentation & Software CD included with your WAC-1001 is designed to make the installation and configuration procedure easy and straightforward. This auto-run CD includes AWK Search Utility (to broadcast search for all WAC/AWK's accessible over the network), the WAC-1001 User's Manual, and Quick Installation Guide.

AWK Search Utility

Installing AWK Search Utility

Click the **INSTALL UTILITY** button in the AWK Installation CD auto-run window to install AWK Search Utility. Once the program starts running, click **Yes** to proceed.

1. Click **Next** when the **Welcome** screen opens to proceed with the installation.

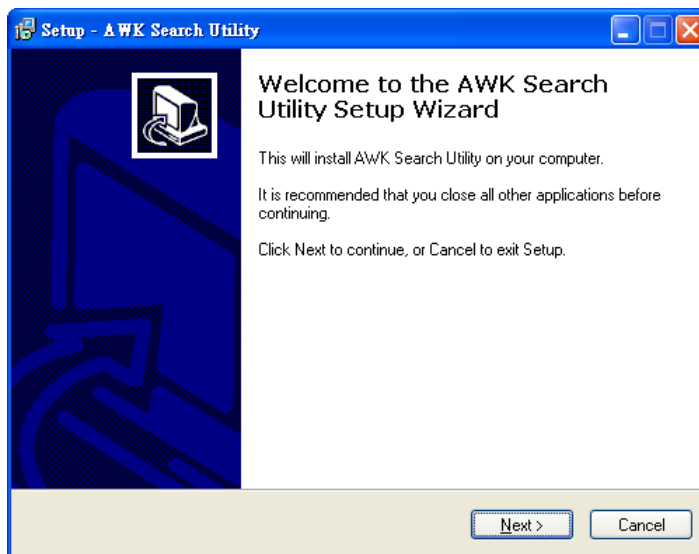

2. Click **Next** to install program files to the default directory, or click **Browse** to select an alternate location.

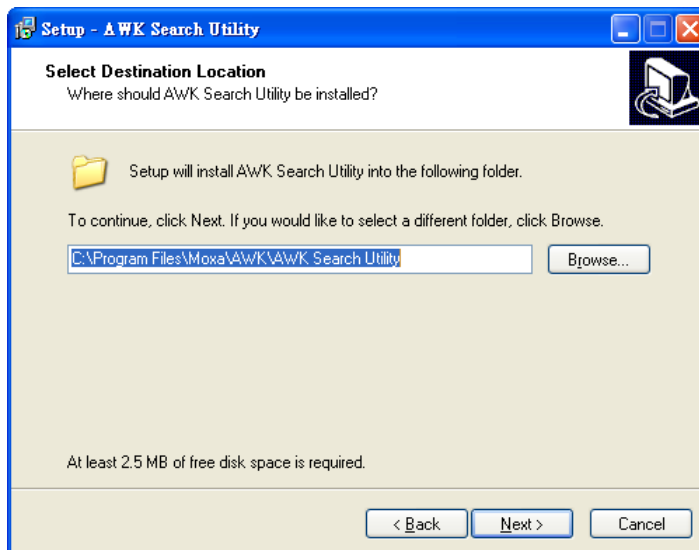

3. Click **Next** to create the program's shortcut files to the default directory, or click **Browse** to select an alternate location.

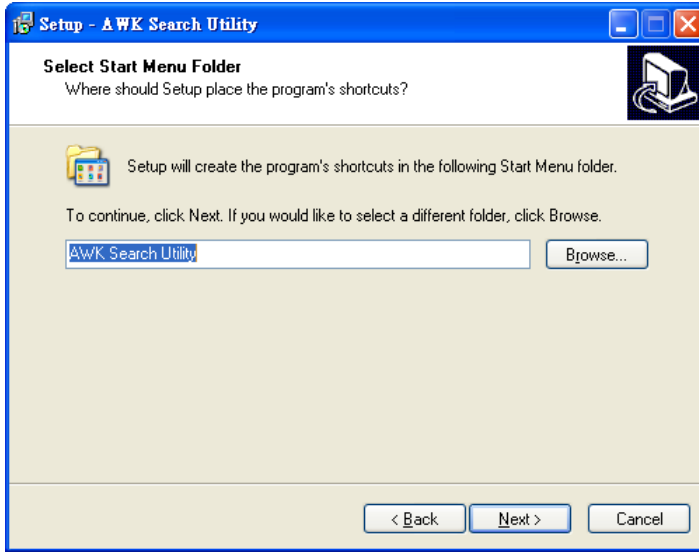

4. Click **Next** to select additional tasks.

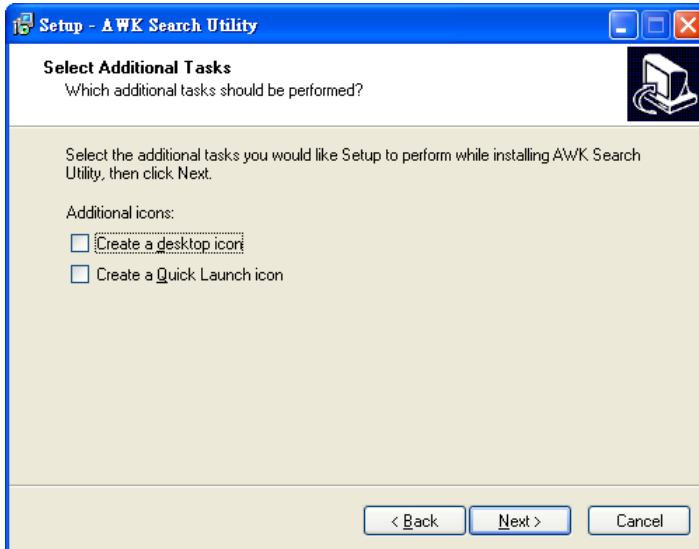

5. Click **Next** to proceed with the installation. The installer then displays a summary of the installation options.

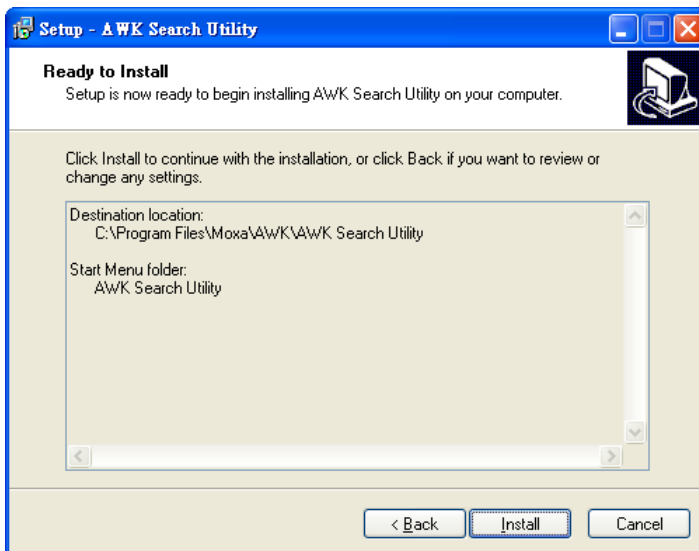

6. Click **Install** to begin the installation. The setup window will report the progress of the installation. To change the installation settings, click **Back** and navigate to the previous screen.
7. Click **Finish** to complete the installation of AWK Search Utility.

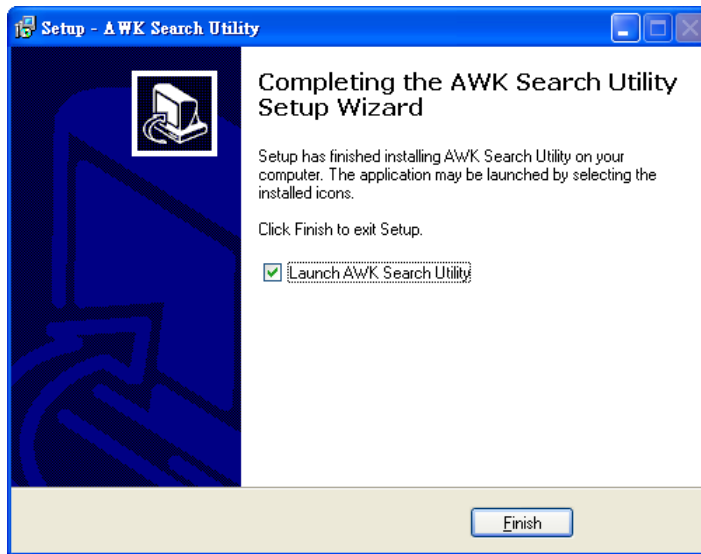

Configuring AWK Search Utility

1. The **Broadcast Search** function is used to locate all AWK APs and WAC controllers that are connected to the same LAN as your computer. After locating a WAC-1001, you will be able to change its IP address. Since the **Broadcast Search** function searches by TCP packet and not IP address, it does not matter if the WAC or AWK is configured as an AP or Client. In either case, APs and Clients connected to the LAN will be located, regardless of whether or not they are part of the same subnet as the host. Start the **AWK Search Utility** program. When the Login page appears, select the "Search AWK only" option to search for AWKs and to view each AWK's configuration. Select the "AWK management" option to assign IPs, upgrade firmware, and locate devices.

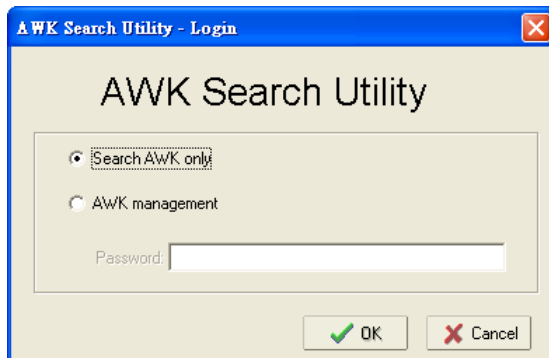

2. Open the AWK Search Utility and then click the **Search** icon.

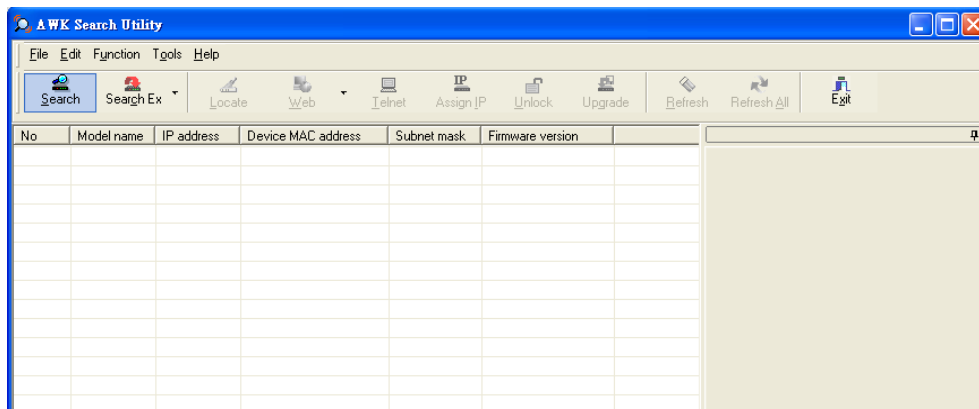

- The "Searching" window indicates the progress of the search. When the search is complete, all WAC and AWK units that were located will be displayed in the AWK Search Utility window.

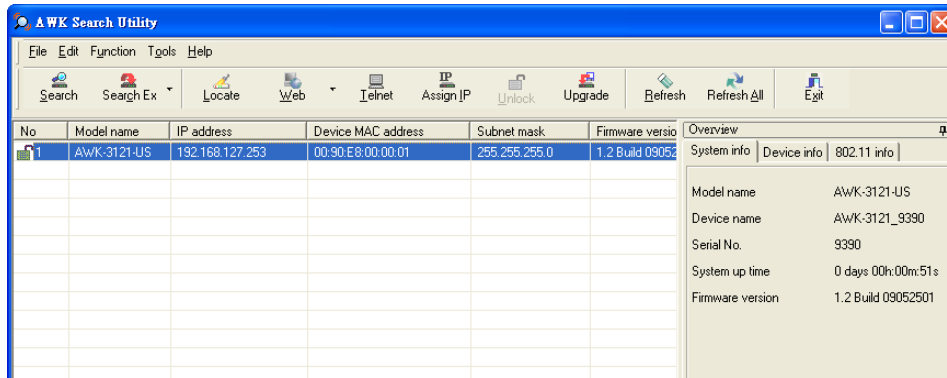

- Click **Locate** to cause the selected device to beep.

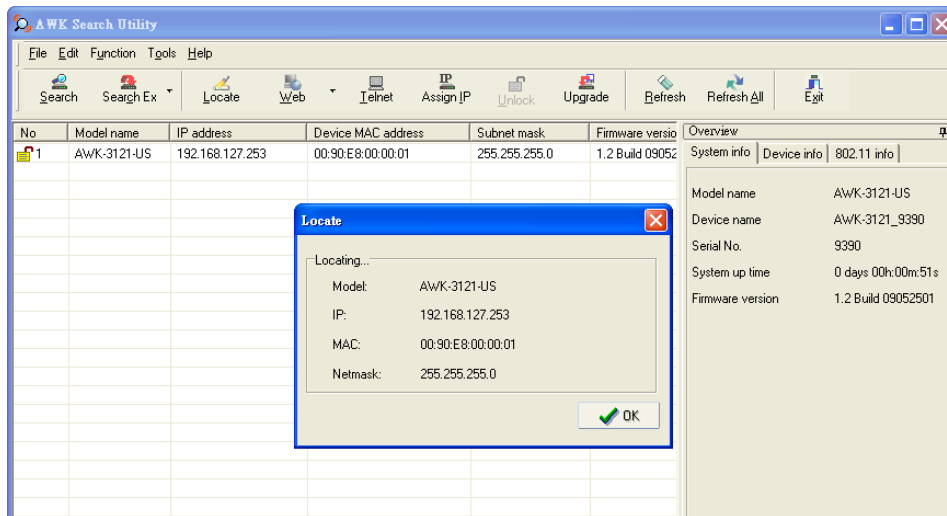

- The **Search Utility** only supports WAC configurations via the Web or telnet (other functions will be deactivated).
- Go to **Tools → AWK login Options** to manage and unlock additional AWKs.

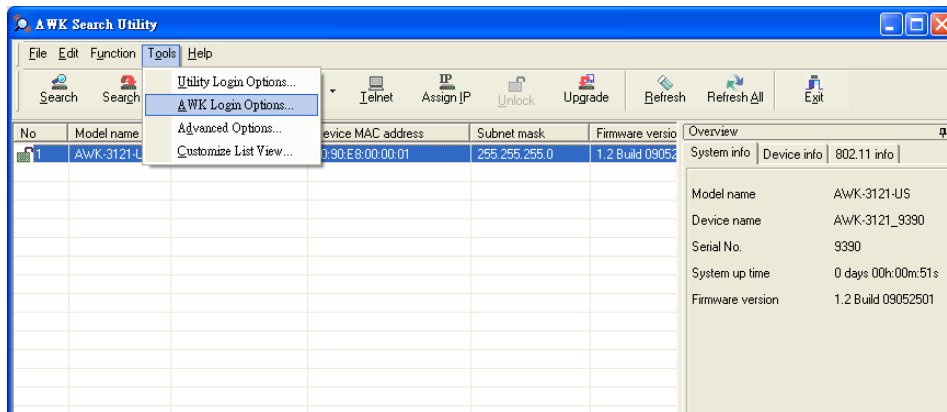

- Use the scroll down list to select the MAC addresses of those AWKs you would like to manage, and then click **Add**. Key in the password for the AWK device and then click **OK** to save. If you return to the search page and search for the AWK again, you will find that the AWK will unlock automatically.



ATTENTION

For security purposes, we suggest you can change the AWK search utility login password instead of using the default.

To modify the configuration of the highlighted WAC or AWK, click on the Web icon to open the web console. This will take you to the web console, where you can make all configuration changes. Refer to Chapter 3, "Using the Web Console," for information on how to use the web console.

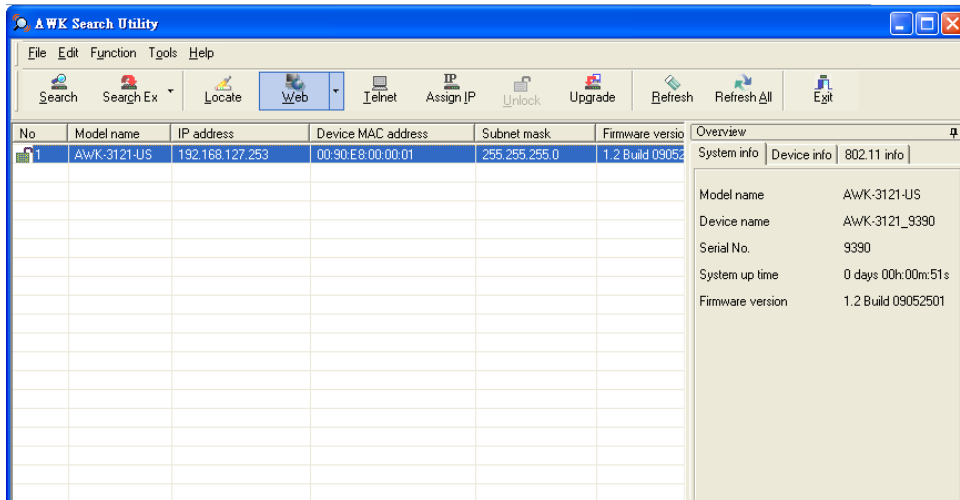

Click on **Telnet** if you would like to use telnet to configure your WACs and AWKs.

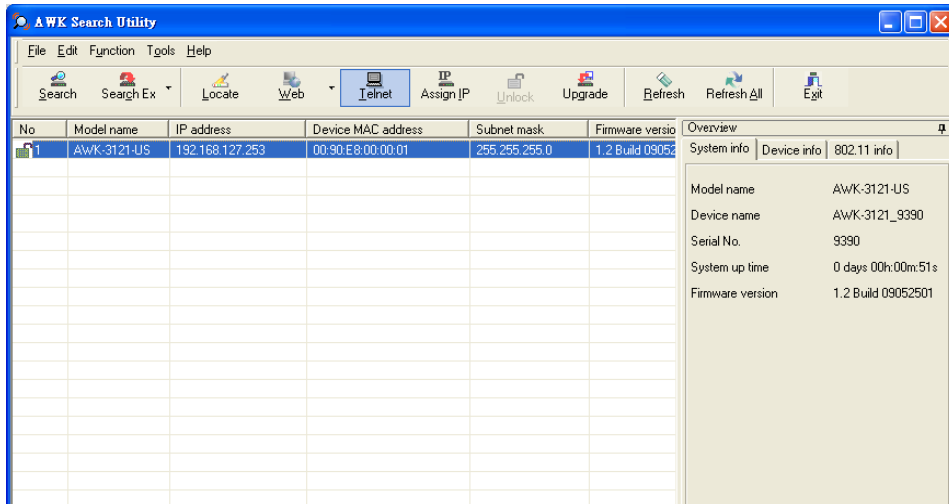

Click **Assign IP** to change the IP setting.

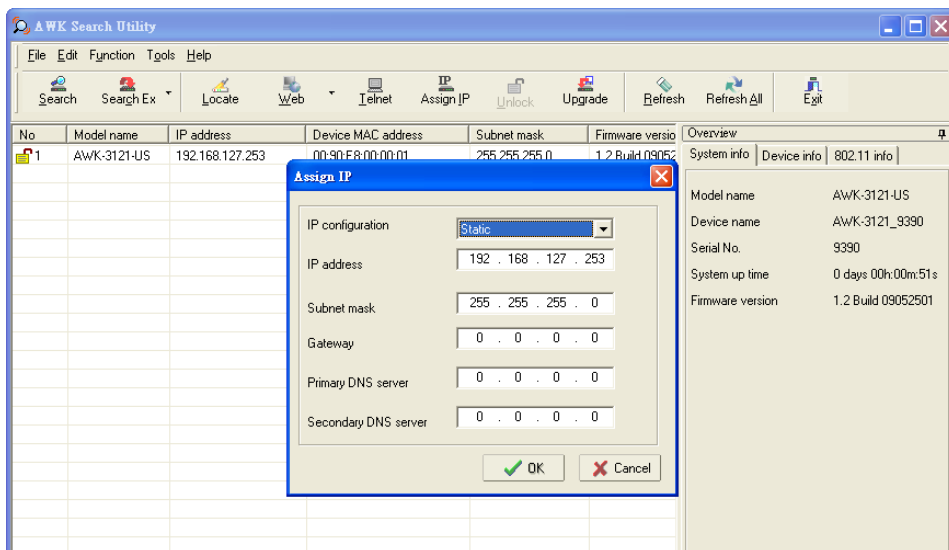

The three advanced options—**Search**, **Connection**, and **Miscellaneous**—are explained below:

Search

- **Retry count (default=5):** Indicates how many times the search will be retried automatically.
- **Retry interval (ms):** The time lapse between retries.

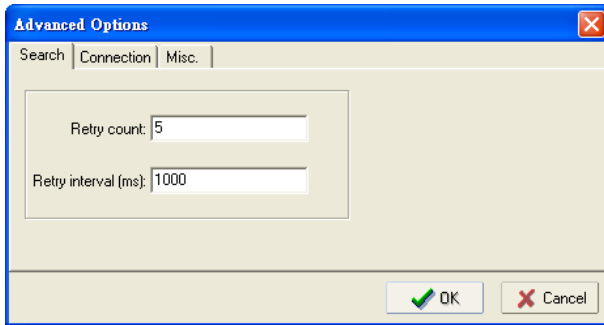

Connection

- **Connection timeout (secs):** Use this option to set the waiting time for the **Default Login**, **Locate**, **Assign IP**, **Upload Firmware**, and **Unlock** to complete.
- **Upgrade timeout (secs):** Use this option to set the waiting time for the connection to disconnect while the firmware is upgrading. Use this option to set the waiting time for the Firmware to write to flash.

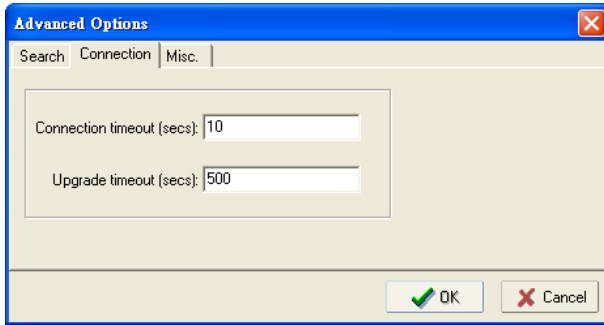

Misc.

Search on start: Checkmark this box if you would like the search function to start searching for devices after you log in to the AWK search Utility.

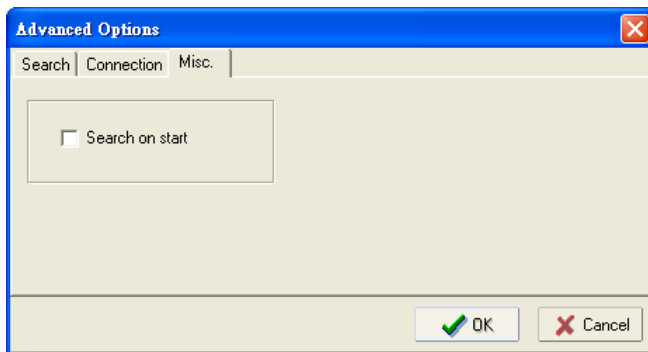

Other Console Considerations

This chapter explains how to access the WAC-1001 with other console connections. In addition to HTTP access, there are four ways to access WAC-1001: serial console, Telnet console, SSH console, and HTTPS console. The serial console connection method, which requires using a short serial cable to connect the WAC-1001 to a PC's COM port, can be used if you do not know the WAC-1001's IP address. The other consoles can be used to access the WAC-1001 over an Ethernet LAN, or over the Internet.

The following topics are covered in this chapter:

- ❑ **RS-232 Console Configuration (115200, None, 8, 1, VT100)**
- ❑ **Configuration by Telnet and SSH Consoles**
- ❑ **Configuration by Web Browser with HTTPS/SSL**
- ❑ **Disabling Telnet and Browser Access**

RS-232 Console Configuration (115200, None, 8, 1, VT100)

The serial console connection method, which requires using a short serial cable to connect the WAC-1001 to a PC's COM port, can be used if you do not know the WAC-1001's IP address. It is also convenient to use serial console configurations when you cannot access the WAC-1001 over Ethernet LAN, such as in the case of LAN cable disconnections or broadcast storming over the LAN.



ATTENTION

Do not use the RS-232 console manager when the WAC-1001 is powered at reversed voltage (ex. -48VDC), even though reverse voltage protection is supported.

If you need to connect the RS-232 console at reversed voltage, Moxa's TCC-82 isolator is your best solution.

NOTE We recommend using **Moxa PComm (Lite)** Terminal Emulator, which can be downloaded free of charge from Moxa's website.

Before running PComm Terminal Emulator, use an RJ45 to DB9-F (or RJ45 to DB25-F) cable to connect the WAC-1001's RS-232 console port to your PC's COM port (generally COM1 or COM2, depending on how your system is set up). After installing PComm Terminal Emulator, take the following steps to access the RS-232 console utility.

1. From the Windows desktop, open the Start menu and start **PComm Terminal Emulator** in the PComm (Lite) group.
2. Select Open under Port Manager to open a new connection.

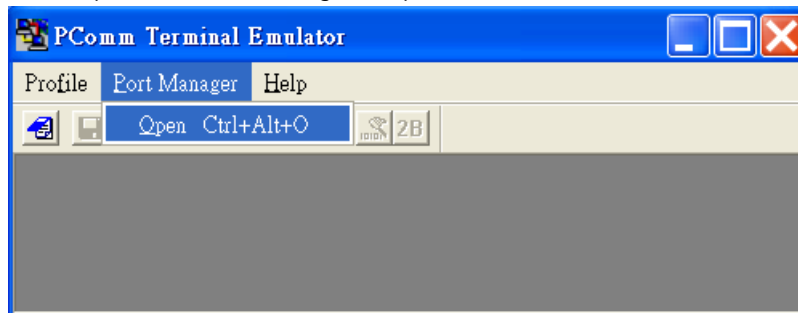

3. The **Communication Parameter** page of the Property window opens. Select the appropriate COM port for Console Connection, **115200** for Baud Rate, **8** for Data Bits, **None** for Parity, and **1** for Stop Bits. Click on the **Terminal** tab, and select **VT100 (or ANSI)** for Terminal Type. Click on **OK** to continue.

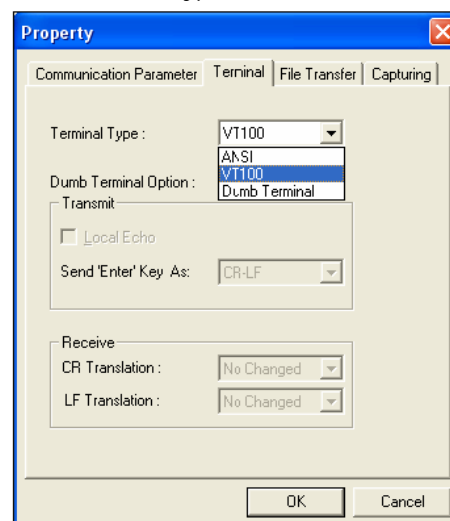
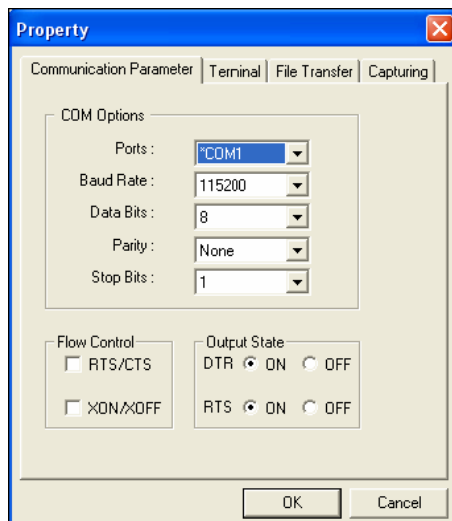

4. The Console login screen will appear. Log into the RS-232 console with the login name (default: **admin**) and password (default: **root**, if no new password is set).

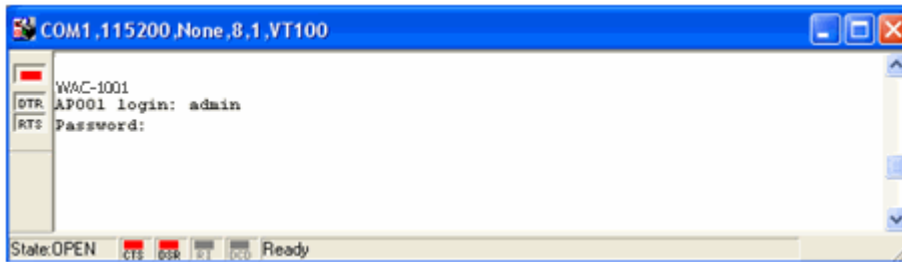

5. The WAC-1001's device information and Main Menu will be displayed. Please follow the description on screen and select the administration option you wish to perform.

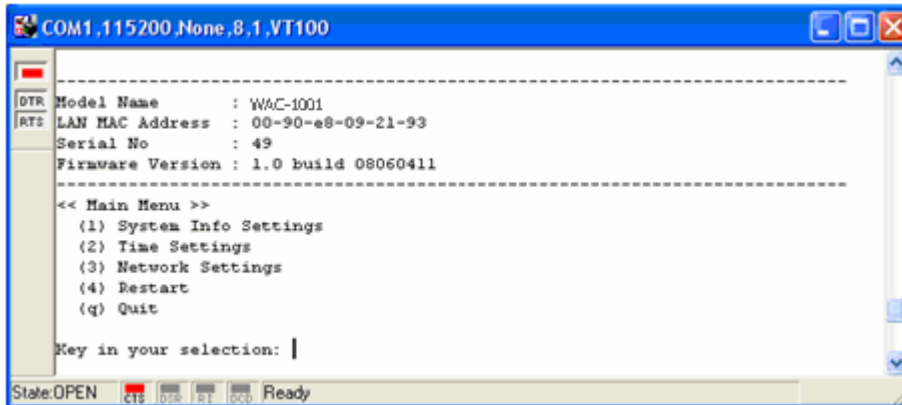

NOTE To modify the appearance of the PComm Terminal Emulator window, select **Edit → Font** and then choose the desired formatting options.



ATTENTION

If you unplug the RS-232 cable or trigger DTR, a disconnection event will be evoked to enforce logout for network security. You will need to log in again to resume operation.

Configuration by Telnet and SSH Consoles

You may use Telnet or SSH client to access the WAC-1001 and manage the console over a network. To access the WAC-1001's functions over the network from a PC host that is connected to the same LAN as the WAC-1001, you need to make sure that the PC host and the WAC-1001 are on the same logical subnet. To do this, check your PC host's IP address and subnet mask.

NOTE The WAC-1001's default IP address is **192.168.127.253** and the default subnet mask is **255.255.255.0** (for a Class C network). If you do not set these values properly, please check the network settings of your PC host and then change the IP address to 192.168.127.xxx and subnet mask to 255.255.255.0.

Follow the steps below to access the console utility via Telnet or SSH client.

1. From Windows Desktop, run **Start** → **Run**, and then use Telnet to access the WAC-1001's IP address from the Windows Run window (you may also issue the telnet command from the MS-DOS prompt).

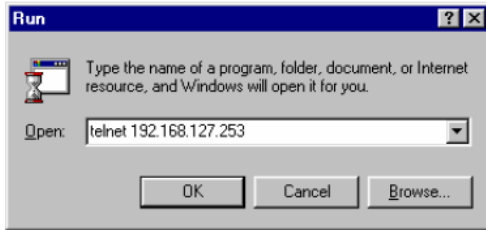

2. When using SSH client (ex. PuTTY), please run the client program (ex. putty.exe) and then input the WAC-1001's IP address, specifying **22** for the SSH connection port.

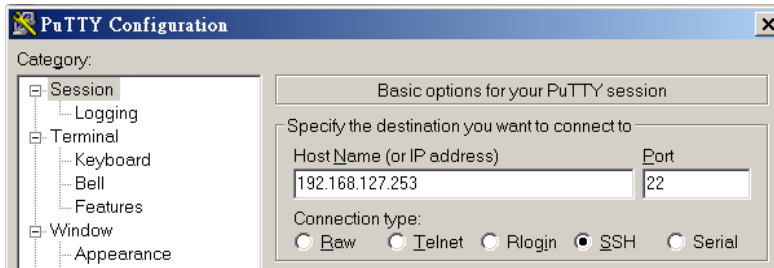

3. The Console login screen will appear. Please refer to the previous paragraph "RS-232 Console Configuration" and for login and administration.

Configuration by Web Browser with HTTPS/SSL

To secure your HTTP access, the WAC-1001 supports HTTPS/SSL encryption for all HTTP traffic. Perform the following steps to access the WAC-1001's web browser interface via HTTPS/SSL.

1. Open your web browser and type `https://<WAC-1001's IP address>` in the address field. Press **Enter** to establish the connection.

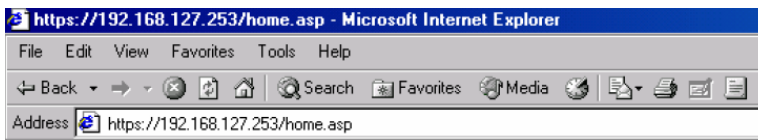

2. Warning messages will pop out to warn users that the security certificate was issued by a company they have not chosen to trust.

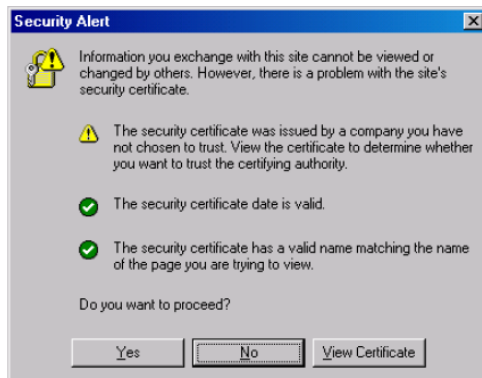

- 3. Select **Yes** to accept the certificate issued by Moxa IW and then enter the WAC-1001's web browser interface secured via HTTPS/SSL. (You can see the protocol in URL is **https**.) Then you can use the menu tree on the left side of the window to open the function pages to access each of WAC-1001's functions.

Overview	
All information on this page are active values.	
System info	
Model name	WAC-1001
Device name	WAC-1001_7589
Serial No.	7589
System up time	0 days 00h:02m:02s
Firmware version	1.4 Build 10112615
Device info	
Device MAC address	00:90:E8:1A:82:34
IP address	192.168.127.253
Subnet mask	255.255.255.0
Gateway	
Controller info	
Roaming method	Compare
Roaming domain	FF:90:E8:1A:82:34

Disabling Telnet and Browser Access

If you are connecting the WAC-1001 to a public network but do not intend to use its management functions over the network, then we suggest disabling both Telnet Console and Web Configuration. Please run **Maintenance** → **Console Settings** to disable them, as shown in the following figure.

Console Settings	
HTTP console	<input type="radio"/> Enable <input checked="" type="radio"/> Disable
HTTPS console	<input checked="" type="radio"/> Enable <input type="radio"/> Disable
Telnet console	<input type="radio"/> Enable <input checked="" type="radio"/> Disable
SSH console	<input checked="" type="radio"/> Enable <input type="radio"/> Disable

A

References

This chapter provides more detailed information about wireless-related technologies. The information in this chapter can help you administer your WAC-1001s and plan your industrial wireless network better.

The following topics are covered in this appendix:

- ❑ **Roaming Domain**
- ❑ **Roaming Method**
 - Compare

Roaming Domain

A roaming domain defines an area where all related wireless controllers, APs, and clients work together to enable fast roaming. Such a domain is specified as six groups of two hexadecimal digits beginning with the fixed identifier, **FF:90:E8**.

Note that the default value of a roaming domain resembles a controller's MAC address; however, it is not necessary to take the last 3-bytes of a controller's MAC address to form a roaming domain. You may take any six hexadecimal digits to form a unique roaming domain; this will be dissimilar enough for other roaming domains to tell themselves apart.

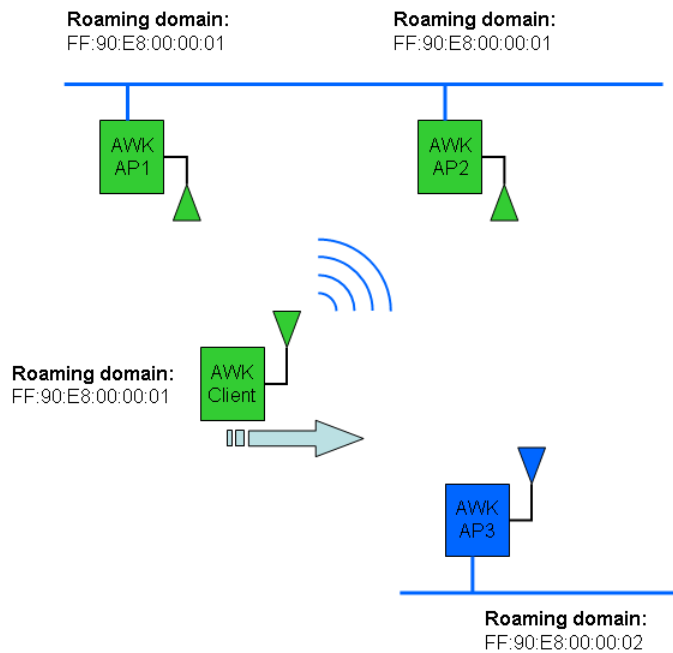

The purpose of a roaming domain is to ensure that wireless clients roam in the same area, and do not jump onto unintended areas. For example, as illustrated above, a wireless client is disconnected from **AWK AP1** and is trying to connect to the next AP. Even though **AWK AP2** and **AWK AP3** have the same SSID, channel, and wireless settings, the client will not roam onto **AWK AP3** because it is in a different roaming domain. A **roaming domain** setting provides wireless clients with consistent roaming among specific APs.

Roaming Method

The **Roaming method** setting offers a strategic roaming mechanism for different applications. Two main factors used to trigger handover determinatively are: the value of RSSI and the RSSI difference.

Compare

The **Compare** method provides an aggressive roaming strategy for distributed wireless infrastructures with a smaller amount of symmetric antenna systems; the illustration below is an example. Upon the detection of a user-specified RSSI difference, handover will be triggered immediately to force the wireless client to connect to the next AP as soon as possible.

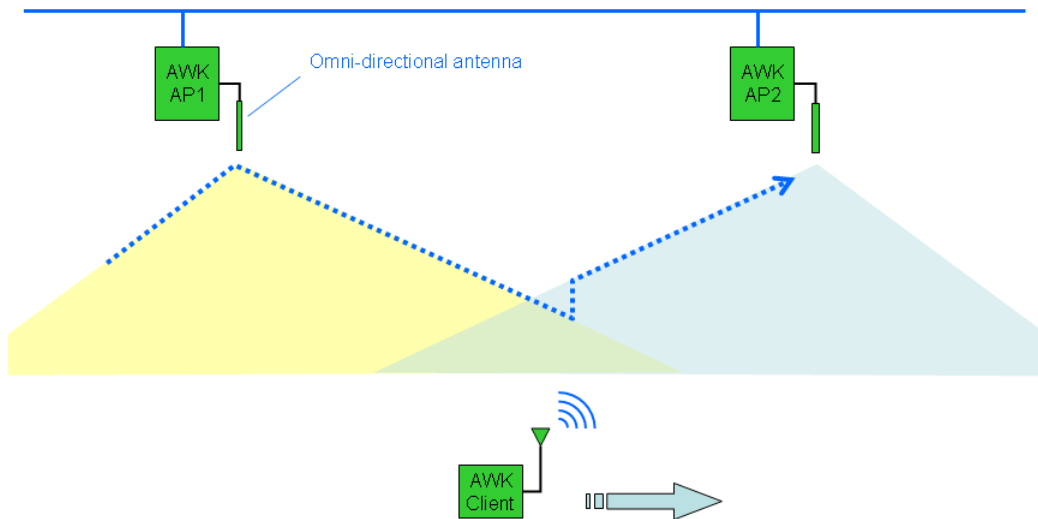

B

Supporting Information

This chapter presents additional information about this manual and product. You can also learn how to contact Moxa for technical support.

The following topics are covered in this appendix:

- **About This User's Manual**
- **DoC (Declaration of Conformity)**
 - Federal Communication Commission Interference Statement
- **Firmware Recovery**

About This User's Manual

This manual is mainly designed for, but not limited to, the following hardware and firmware for the WAC-1001:

- Hardware Rev: **2.xx.x**
- Firmware Ver: **2.x**

You are strongly recommended to visit Moxa's website (<http://www.moxa.com>) to find the latest product datasheet, firmware, QIG (Quick Installation Guide), UM (User's Manual), and related information.

NOTE The WAC's hardware revision number is located on a label on the side panel.

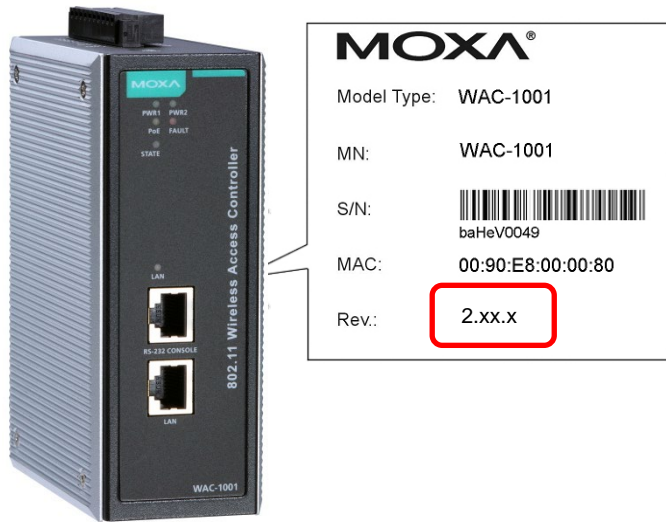

The firmware version number can be seen on the **Overview** page, as illustrated below:

System Info	
Model name	WAC-1001
Device name	WAC-1001_1030
Serial No.	1030
System up time	0 days 00h:42m:32s
Firmware version	2.0 Build 15062519

DoC (Declaration of Conformity)

Federal Communication Commission Interference Statement

This equipment has been tested and found to comply with the limits for a Class B digital device, pursuant to Part 15 of the FCC Rules. These limits are designed to provide reasonable protection against harmful interference in a residential installation. This equipment generates, uses and can radiate radio frequency energy and, if not installed and used in accordance with the instructions, may cause harmful interference to radio communications. However, there is no guarantee that interference will not occur in a particular installation. If this equipment does cause harmful interference to radio or television reception, which can be determined by turning the equipment off and on, the user is encouraged to try to correct the interference by one of the following measures:

- Reorient or relocate the receiving antenna.
- Increase the separation between the equipment and receiver.
- Connect the equipment into an outlet on a circuit different from that to which the receiver is connected.
- Consult the dealer or an experienced radio/TV technician for help.

FCC Caution: To assure continued compliance, (example – use only shielded interface cables when connecting to computer or peripheral devices). Any changes or modifications not expressly approved by the party responsible for compliance could void the user's authority to operate this equipment. This transmitter must not be co-located or operated in conjunction with any other antenna or transmitter.

FCC Radiation Exposure Statement

This equipment complies with FCC radiation exposure limits set forth for an uncontrolled environment. This equipment should be installed and operated with a minimum distance of 20 cm between the radiator & your body.

This device complies with Part 15 of the FCC Rules. Operation is subject to the following two conditions: (1) This device may not cause harmful interference, and (2) this device must accept any interference received, including interference that may cause undesired operation.

NOTE	The availability of some specific channels and / or operational frequency bands are country dependent and are firmware programmed at the factory to match the intended destination. The firmware setting is not accessible by the end user.
-------------	---

Firmware Recovery

When the **FAULT**, **Signal Strength**, and **WLAN** LEDs all light up simultaneously and blink at one-second intervals, it means the system boot has failed. This could be the result of an erroneous operation or other issue beyond your control, such as an unexpected shutdown during the firmware update. The WAC-1001 is designed to help administrators recover from any damage caused by a system boot failure, and resume system operation rapidly. Refer to the following instructions to see how to recover the firmware:

Connect to the WAC-1001's RS-232 console with **115200bps and N-8-1**. The following message will be shown on the terminal emulator once every second.

```

please set-up TFTP server 192.168.127.1 contains wac-1001v2.rom for firmware recovery.
please set-up TFTP server 192.168.127.1 contains wac-1001v2.rom for firmware recovery.
please set-up TFTP server 192.168.127.1 contains wac-1001v2.rom for firmware recovery.
please set-up TFTP server 192.168.127.1 contains wac-1001v2.rom for firmware recovery.
please set-up TFTP server 192.168.127.1 contains wac-1001v2.rom for firmware recovery.
please set-up TFTP server 192.168.127.1 contains wac-1001v2.rom for firmware recovery.

```

Take the following steps for firmware recovery:

1. Change the IP address of the laptop to 192.168.127.1.
2. Set up a TFTP server on your laptop.
3. Download the WAC-1001's firmware from Moxa's website
4. Change the firmware file name to wac-1001v2.rom.
5. Connect to the WAC-1001's RJ45 Ethernet port

If the settings are correct, the following message will be shown on the terminal emulator, and the WAC-1001 will reboot when the firmware recovery process has finished.

```
Trying eth0
Using eth0 device
TFTP from server 192.168.127.1; our IP address is 192.168.127.253
Filename 'wac-1001v2.rom'.
Load address: 0x80060000
Loading:
*#####
#####
#####
```