

V2403

Quick Installation Guide

Edition 1.0, September 2015

Technical Support Contact Information

www.moxa.com/support

Moxa Americas:

Toll-free: 1-888-669-2872

Tel: 1-714-528-6777

Fax: 1-714-528-6778

Moxa China (Shanghai office):

Toll-free: 800-820-5036

Tel: +86-21-5258-9955

Fax: +86-21-5258-5505

Moxa Europe:

Tel: +49-89-3 70 03 99-0

Fax: +49-89-3 70 03 99-99

Moxa Asia-Pacific:

Tel: +886-2-8919-1230

Fax: +886-2-8919-1231

Moxa India:

Tel: +91-80-4172-9088

Fax: +91-80-4132-1045



© 2015 Moxa Inc. All rights reserved.

P/N: 1802024030010



Overview

The Moxa V2403 series fanless x86 embedded computer is based on the Intel® 3rd gen Core-i™ series processor, features the most reliable I/O design to maximize connectivity, and supports dual wireless modules, making it suitable for a diverse range of communication applications. The computer's thermal design ensures reliable system operation in temperatures ranging from -40 to 70°C with a special purpose Moxa wireless module installed. The V2403 series supports "Moxa Hardware Monitoring" for device I/O status monitoring and alerts, system temperature monitoring and alerts, and system power management. Closely monitoring system status makes it easier to recover from errors and provides the most reliable platform for your applications.

Package Checklist

Before installing the V2403, verify that the package contains the following items:

- V2403 embedded computer
- Terminal block to power jack converter
- Wall mounting kit
- Quick installation guide (printed)
- Warranty card

NOTE: Please notify your sales representative if any of the above items are missing or damaged.

V2403 Panel Layout

The following figures show the panel layouts of the V2403.

Front View

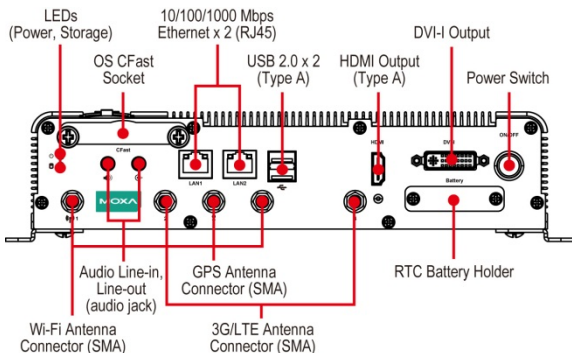

Rear View

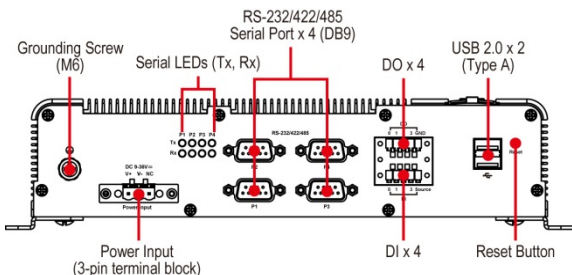

LED Indicators

The following table describes the LED indicators located on the front panel of the V2403.

LED Name	LED Color	LED Function
Power	Green	Power is on and functioning normally.
	Off	Power is off or power error exists.
Storage	Yellow	CFast card/HDD/SSD is transmitting data
	Off	CFast card/HDD/SSD is not transmitting data
LAN (1 or 2)	Green	100 Mbps Ethernet mode
	Yellow	1000 Mbps Ethernet mode
	Off	10 Mbps or no activity
TX (P1-P4)	Green	Serial ports P1-P4 transmitting data
	Off	Serial ports P1-P4 not transmitting data
RX (P1-P4)	Yellow	Serial ports P1-P4 receiving data
	Off	Serial ports P1-P4 not receiving data

NOTE The mini-PCIe card's LED behavior depends on the module.

Installing the Mini-PCIe Modules and USIM Cards



ATTENTION

Select "-W" models (e.g., V2403-C2-W-T) when placing V2403 orders for wireless applications. Moxa will add 3 mini-PCIe sockets during production. Note that the internal storage kit cannot be used with "-W" models. To expand the storage of "-W" models, use an mSATA card.

The V2403 features 3 mini-PCIe sockets on the bottom panel.

- **Socket 1:** USB + PCIe signal, for Wi-Fi mini-PCIe card
- **Socket 2:** USB signal, for 3G/LTE mini-PCIe card (Sierra Wireless MC7304, MC7354, MC9090)
- **Socket 3:** SATA signal (for mSATA)

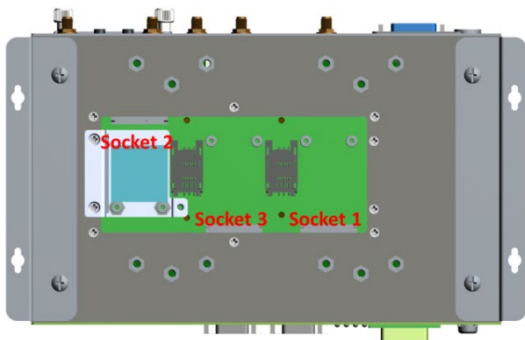

Installing a mini-PCIe Card in Socket 1 and Socket 3

STEP 1: Loosen the 6 screws in the middle of the bottom cover and then open the bottom cover.

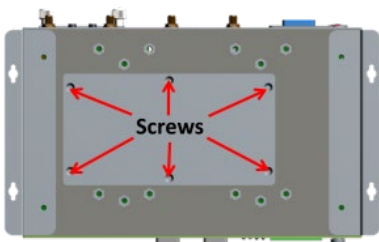

STEP 2: Obliquely insert the mini-PCIe module card.

STEP 3: Push down the mini-PCIe module card and fasten it with the 2 black screws from the module card package you purchased from Moxa.

STEP 4: If you installed a wireless mini-PCIe card, connect the antenna cables with wireless module card.

No.1 & No.3: Wi-Fi mini-PCIe card.

STEP 5: Replace the bottom cover.

Installing a mini-PCIe Card in Socket 2

STEP 1: Loosen the 6 screws in the middle of the bottom cover and open the bottom cover.

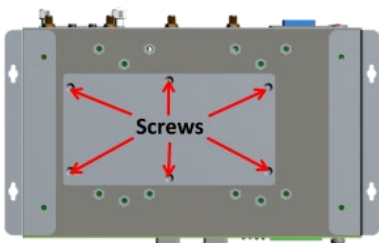

STEP 2: Get the upper heat sink cover from the wireless package.



STEP 3: Obliquely insert the mini-PCIe module card in socket 2, and fasten it with the 2 black screws from the wireless package.

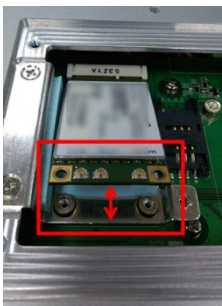

STEP 4: Connect the antenna cables to the wireless module card:

No. 2 & No. 4: 3G/LTE mini-PCIe card
No. 5: GPS



STEP 5: Use the fillister to obliquely buckle the heat sink that was already installed inside the V2403 computer, as shown below:

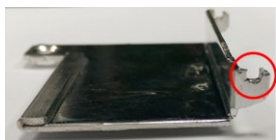

STEP 6: Slightly push down the upper heat sink cover and use the silver screw from the wireless package to fasten the upper heat sink cover (outlined in red below).



STEP 7: Replace the bottom cover.

Installing the USIM card

The V2403 has 2 USIM slots for 3G/LTE wireless Internet connections. Instructions for installing a USIM card are shown below:

Pull up the USIM card slot and insert the USIM card. When finished, replace the holder and slide the slot towards the catch to fasten the holder.



NOTE You may also purchase 3G, 4G, and Wi-Fi external antennas from Moxa. Please contact Moxa sales representative for your demand.

Installing the V2403

DIN-Rail Mounting

The V2403 can be installed on a DIN-rail with the optional DIN-rail kit. The DIN-rail kit must be purchased separately. The DIN-rail kit includes two DIN-rail brackets and eight screws.

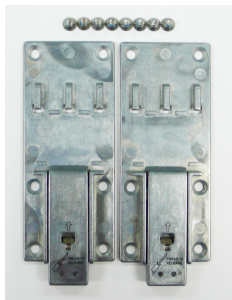

To attach the DIN-rail kit, complete the following steps:

1. Turn the V2403 over so the bottom is facing up.
2. Locate the screw holes on the bottom of the V2403.

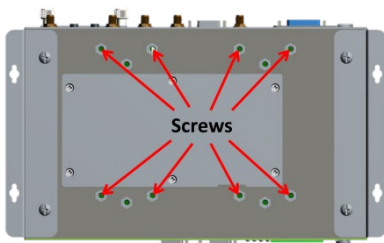

3. Place the brackets on the bottom of the V2403 and align the screw holes on the brackets with the screw holes on the V2403.
4. Insert and tighten the screws into the screw holes.

NOTE Use all eight screws to ensure that the V2403 is safely and securely installed on the DIN rail.

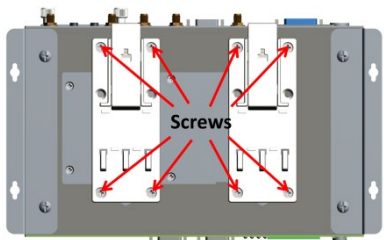

5. When the brackets are firmly attached with the screws, you can install the V2403 onto a DIN-rail.

To remove the V2403 from the DIN-rail, first use a screwdriver to pull down the DIN-rail connector to unlock it.

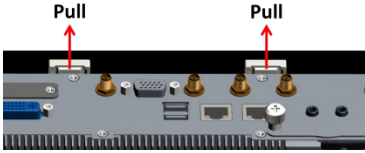

To re-install the V2403 on the DIN-rail, use a screwdriver to press the buckle so that it can be released. At this point, it can be re-installed on the DIN-rail.

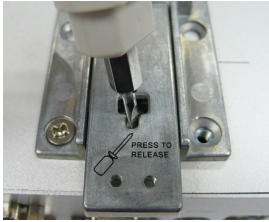

Wall or Cabinet Mounting

The V2403 comes with two metal brackets for attaching it to a wall or the inside of a cabinet.

Step 1: Use two screws for each bracket and attach the bracket to the rear of the V2403.

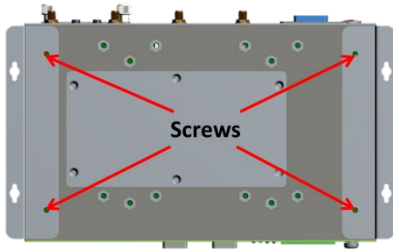

Step 2: Use four screws per side to attach the V2403 to a wall or cabinet.

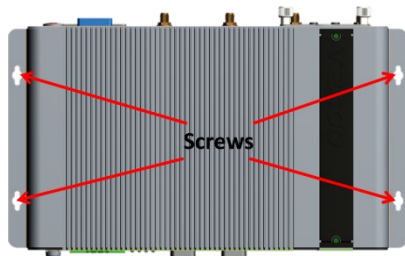

Connector Description

Power Connector

Connect the 9 to 36 VDC LPS or Class 2 power line to the V2403's terminal block. If the power is supplied properly, the Power LED will light up. The OS is ready when the Ready LED glows a solid green.

Grounding the V2403

Grounding and wire routing help limit the effects of noise due to electromagnetic interference (EMI). Run the ground connection from the grounding screw (M4) to the grounding surface prior to connecting the power.

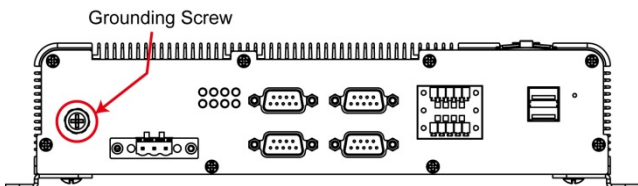

ATTENTION

This product is intended to be mounted to a well-grounded mounting surface, such as a metal panel.

DVI-I Outputs

The V2403 comes with 1 DVI-I female connector for the DVI display. This output interface is located on the front panel of the product. Be sure to use the correct cable to connect the computer to the display.

HDMI Outputs

The V2403 comes with a type A HDMI female connector and a DVI-I female connector on the front panel to connect an HDMI or DVI-I supported monitor.

The screw hole above the HDMI connector is used to attach a customized lock to the HDMI connector; a custom lock is needed since the shape of different HDMI connectors are not the same. Please contact a Moxa sales representative for details.

The lock appears as shown below:



The lock should appear as shown here after it is attached to the V2403:



Ethernet Ports

The 10/100/1000 Mbps Ethernet ports use RJ45 connectors.

Pin	10/100 Mbps	1000 Mbps
1	ETx+	TRD(0)+
2	ETx-	TRD(0)-
3	ERx+	TRD(1)+
4	–	TRD(2)+
5	–	TRD(2)-
6	ERx-	TRD(1)-
7	–	TRD(3)+
8	–	TRD(3)-

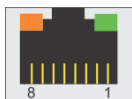

Serial Ports

The serial ports use DB9 connectors. Each port can be configured by software for RS-232, RS-422, or RS-485. The pin assignments for the ports are shown in the following table:

Pin	RS-232	RS-422	RS-485 (4-wire)	RS-485 (2-wire)
1	DCD	TxDA(-)	TxDA(-)	–
2	RxD	TxDB(+)	TxDB(+)	–
3	TxD	RxDB(+)	RxDB(+)	DataB(+)
4	DTR	RxDA(-)	RxDA(-)	DataA(-)
5	GND	GND	GND	GND
6	DSR	–	–	–
7	RTS	–	–	–
8	CTS	–	–	–

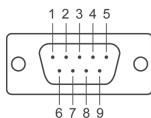

SATA Connector

The V2403 has 1 SATA-I/II connector for 2.5" SSD/HDD storage expansion. To expand storage capacity, purchase an SSD/HDD and an internal storage kit* through Moxa's CTO** service.

*Must be purchased separately for installing an SSD/HDD. For details, check the optional accessories section of the V2403 datasheet.

**CTO = Configure to order

mSATA Connector

The V2403 has 1 mini-PCIe socket with SATA signal for storage expansion. Follow the "Installing the Wireless Modules" instructions.

CFast Slot

The V2403 has 2 CFast sockets. One slot is located on the front panel for OS storage and the other slot is located inside the V2403 for backup OS storage. Both slots support CFast Type-I/II with DMA mode.

To install an OS CFast card, remove the outer cover and insert the CFast card in the socket. When finished, push the cover into the socket and refasten the screws.

To install a CFast card for backup storage, purchase a CFast card through Moxa's CTO service. Refer to the V2406A datasheet for more information.

USB Hosts

The V2403 has 4 USB 2.0 Type A connectors. 2 USB ports are located on the front panel; the other 2 USB ports are located on the rear panel. The port supports keyboard and mouse, and can also be used to connect a FlashDisk for storing large amounts of data.

Audio Interface

The V2403 comes with a Line-in audio connector for audio input and a Line-out audio connector for audio output, allowing users to connect a speaker or earphones.

DI/DO

The V2403 comes with 4 digital inputs and 4 digital outputs on a 2x5 terminal block.

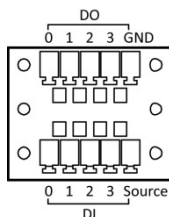

Reset Button

Press the "Reset Button" on the rear panel of the computer to reboot the system automatically. Pushing the reset button will restart system immediately. Be aware that all unsaved data will be lost when pushing this button.

Real-time Clock (RTC)

The V2403's real-time clock is powered by a lithium battery. You can easily replace the battery yourself using an optional battery kit*. However, please note that there is a risk of explosion if the battery is replaced by an incorrect type of battery. Refer to the V2403 Hardware User's Manual or contact a qualified Moxa support engineer if you have any questions about the RTC battery.

*Moxa offers an "RTC battery kit" that you can use to easily replace the battery. For details, check the optional accessories section of the V2403 datasheet.



ATTENTION

There is a risk of explosion if the battery is replaced by an incorrect type of battery.

Powering on the V2403

To power on the V2403, connect the "terminal block to power jack converter" to the V2403's DC terminal block (located on the side panel), and then connect the 9 to 36 VDC power adapter. Press the Power Button to turn on the computer. Note that the Shielded Ground wire should be connected to the top pin of the terminal block. It takes about 30 seconds for the system to boot up. Once the system is ready, the Power LED will light up.

Connecting the V2403 to a PC

Power on the V2403 computer after connecting a monitor, keyboard, and mouse, and verifying that the power source is ready. Once the operating system boots up, first configure the Ethernet interface. The factory default settings for the V2403's LANs are show below (W7E uses DHCP).

	Default IP Address	Netmask
LAN 1	192.168.3.127	255.255.255.0

LAN 2	192.168.4.127	255.255.255.0
-------	---------------	---------------

Configuring the Ethernet Interface

Linux users should follow these steps:

If you use the console cable to configure network settings for the first time, use the following commands to edit the interfaces file:

```
#ifdown -a
//Disable LAN1~LAN2 interface first, before you
reconfigure the LAN settings. LAN1 = eth0, LAN2 = eth1//
#vi /etc/network/interfaces
//check the LAN interface first//
```

After the boot setting of the LAN interface has been modified, use the following commands to immediately activate the LAN settings:

```
#sync; ifup -a
```

W7E users should follow these steps:

STEP 1: Go to Start → Control Panel → Network and Internet → View network status and tasks → Change adapter setting.

STEP 2: In the Local Area Connection Properties screen, click Internet Protocol (TCP/IP) and then select Properties. Select Internet Protocol Version 4, and then click Properties.

STEP 3: Click OK after inputting the proper IP address and netmask.

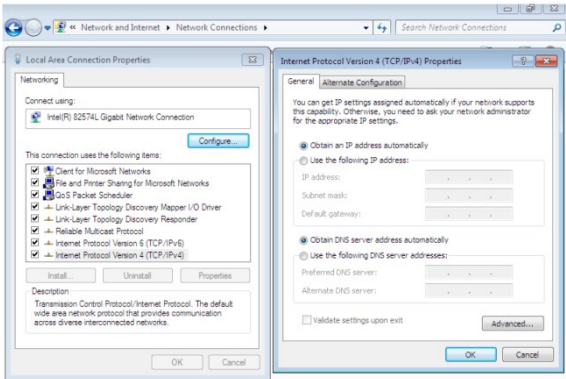

NOTE Refer to the V2403 user's manuals for additional configuration information.