

DrayTek

Vigor2915 Series

Dual-WAN Security Router



QUICK START GUIDE (RF MODEL)

V1.1

Vigor2915 Series Dual-WAN Security Router Quick Start Guide (For RF Model)

Version:1.1

Firmware Version: V4.0.5

(For future update, please visit [DrayTek web site](http://www.draytek.com))

Date: March 24, 2020

Intellectual Property Rights (IPR) Information

Copyrights

© All rights reserved. This publication contains information that is protected by copyright. No part may be reproduced, transmitted, transcribed, stored in a retrieval system, or translated into any language without written permission from the copyright holders.

Trademarks

The following trademarks are used in this document:

- Microsoft is a registered trademark of Microsoft Corp.
- Windows, Windows 95, 98, Me, NT, 2000, XP, Vista, 7, 8 and Explorer are trademarks of Microsoft Corp.
- Apple and Mac OS are registered trademarks of Apple Inc.
- Other products may be trademarks or registered trademarks of their respective manufacturers.

Safety Instructions and Approval

Safety

Instructions

- Read the installation guide thoroughly before you set up the router.
- The router is a complicated electronic unit that may be repaired only by authorized and qualified personnel. Do not try to open or repair the router yourself.
- Do not place the router in a damp or humid place, e.g. a bathroom.
- Do not stack the routers.
- The router should be used in a sheltered area, within a temperature range of 0 to +40 Celsius.
- Do not expose the router to direct sunlight or other heat sources. The housing and electronic components may be damaged by direct sunlight or heat sources.
- Do not deploy the cable for LAN connection outdoor to prevent electronic shock hazards.
- Keep the package out of reach of children.
- When you want to dispose of the router, please follow local regulations on conservation of the environment.

Warranty

We warrant to the original end user (purchaser) that the router will be free from any defects in workmanship or materials for a period of two (2) years from the date of purchase from the dealer. Please keep your purchase receipt in a safe place as it serves as proof of date of purchase. During the warranty period, and upon proof of purchase, should the product have indications of failure due to faulty workmanship and/or materials, we will, at our discretion, repair or replace the defective products or components, without charge for either parts or labor, to whatever extent we deem necessary to restore the product to proper operating condition. Any replacement will consist of a new or re-manufactured functionally equivalent product of equal value, and will be offered solely at our discretion. This warranty will not apply if the product is modified, misused, tampered with, damaged by an act of God, or subjected to abnormal working conditions. The warranty does not cover the bundled or licensed software of other vendors. Defects which do not significantly affect the usability of the product will not be covered by the warranty. We reserve the right to revise the manual and online documentation and to make changes from time to time in the contents hereof without obligation to notify any person of such revision or changes.



Declaration of Conformity

Hereby, DrayTek Corporation declares that the radio equipment type Vigor2915 is in compliance with Directive 2014/53/EU.

The full text of the EU declaration of conformity is available at the following internet address:

<http://www.draytek.com.tw/ftp/Vigor2915/Document/CE/>

Manufacturer: DrayTek Corp.

Address: No. 26, Fu Shing Road, HuKou Township, HsinChu Industrial Park, Hsin-Chu County, Taiwan 303

Product: Vigor2915 Series

Frequency Information for Europe area:

2.4G WLAN	2412MHz - 2472 MHz, max. TX power: 19.98dBm *1
5G WLAN	5170MHz - 5250 MHz, max. TX power: 22 dBm *2
	Requirements in AT/BE/BG/CZ/DZ/DK/EE/FR/DE/IS/IE/IT/EL/ES/CY/LV/LI/LT/LU/HU/MT/NL/NO/PL/PT/RO/SI/SK/TR/FI/SE/CH/UK/HR. 5170MHz~5250MHz is for indoor use only.

(*1: for 2.4G WLAN model; *2: for 5G WLAN model)

This product is designed for 2.4GHz /5GHz WLAN network throughout the EC region.



Regulatory Information

Federal Communication Commission Interference Statement

This equipment has been tested and found to comply with the limits for a Class B digital device, pursuant to Part 15 of the FCC Rules. These limits are designed to provide reasonable protection against harmful interference in a residential installation. This equipment generates, uses and can radiate radio frequency energy and, if not installed and used in accordance with the instructions, may cause harmful interference to radio communications. However, there is no guarantee that interference will not occur in a particular installation. If this equipment does cause harmful interference to radio or television reception, which can be determined by turning the equipment off and on, the user is encouraged to try to correct the interference by one of the following measures:

- Reorient or relocate the receiving antenna.
- Increase the separation between the equipment and receiver.
- Connect the equipment into an outlet on a circuit different from that to which the receiver is connected.
- Consult the dealer or an experienced radio/TV technician for help.

This device complies with Part 15 of the FCC Rules. Operation is subject to the following two conditions:

- (1) This device may not cause harmful interference, and
- (2) This device may accept any interference received, including interference that may cause undesired operation.

USA Local Representative	Company name	ABP International Inc.		
	Address	13988 Diplomat Drive Suite 180 Dallas TX 75234		
	ZIP Code	75234	E-mail	rmesser@abptech.com
	Contact Person	Mr. Robert Messer	Tel.	19728311600

Caution:

- Any changes or modifications not expressly approved by the party responsible for compliance could void the user's authority to operate this equipment.
- The antenna/transmitter should be kept at least 20 cm away from human body.
- Operations in the 5.15-5.25GHz band are restricted to indoor usage only.

External Power Supply ErP Information

	1	2	3	4	5	6	7	8	9
A Manufacturer	CWT	CWT	CWT	CWT	CWT	APD	APD	APD	APD
B Address	No. 222, Sec. 2, Nankan Rd., Lujhu Township, Taoyuan County 338, Taiwan	No. 222, Sec. 2, Nankan Rd., Lujhu Township, Taoyuan County 338, Taiwan	No. 222, Sec. 2, Nankan Rd., Lujhu Township, Taoyuan County 338, Taiwan	No. 222, Sec. 2, Nankan Rd., Lujhu Township, Taoyuan County 338, Taiwan	No. 222, Sec. 2, Nankan Rd., Lujhu Township, Taoyuan County 338, Taiwan	No.5, Lane 83, Lung-Sou St., Taoyuan City 330, Taiwan	No.5, Lane 83, Lung-Sou St., Taoyuan City 330, Taiwan	No.5, Lane 83, Lung-Sou St., Taoyuan City 330, Taiwan	No.5, Lane 83, Lung-Sou St., Taoyuan City 330, Taiwan
C Model identifier	2ABB012F UK 2ABB012F EU	2ABB018F UK 2ABB018F EU	2ABLO24F UK 2ABLO24F EU	2ABLO30F UK 2ABLO30F EU	2ABNO36F UK 2ABNO36F EU	WA-12M12FG WA-12M12FK	WB-18D12FG WB-18D12FK	WA-24Q12FG WA-24Q12FK	WA-36A12FG WA-36A12FK
D Input voltage	100-240V	100-240V	100-240V	100-240V	100-240V	100-240V	100-240V	100-240V	100-240V
E Input AC frequency	50/60Hz	50/60Hz	50/60Hz	50/60Hz	50/60Hz	50/60Hz	50/60Hz	50/60Hz	50/60Hz
Output voltage DC	12.0V	12.0V	12.0V	12.0V	12.0V	12.0V	12.0V	12.0V	12.0V
F Output current	1.0A	1.5A	2.0A	2.5A	3.0A	1.0A	1.5A	2.0A	3.0A
G Output power	12.0W	18.0W	24.0W	30.0W	36.0W	12.0W	18.0W	24.0W	36.0W
H Average active efficiency	84.9%	86.2%	87.6%	87.8%	89.8%	83.7%	85.4%	88.6%	88.2%
I Efficiency at low load 10%	73.6%	78.0%	81.3%	83.3%	83.7%	74.5%	80.5%	86.4%	85.4%
J No-load power consumption	0.07W	0.07W	0.07W	0.07W	0.07W	0.07W	0.10W	0.07W	0.10W

*The external power supply used for each product will be model dependent.

For more update, please visit www.draytek.com.



Table of Contents

1. Introduction.....	1
2. Package Content	2
3. Panel Explanation.....	3
3.1 Vigor2915ac	3
3.2 Vigor2915Fac.....	5
4. Hardware Installation	7
4.1 Network Connection.....	7
4.2 Wall-Mounted Installation.....	8
5. Software Configuration	9
6. Customer Service	15
Be a Registered Owner	15
Firmware & Tools Updates	15

1. Introduction

Vigor2915 series is a broadband router which integrates IP layer QoS, NAT session/bandwidth management to help users control works well with large bandwidth.

By adopting hardware-based VPN platform and hardware encryption of AES/DES/3DES, and hardware key hash of SHA-1/MD5, the router increases the performance of VPN greatly and offers several protocols (such as IPSec/PPTP/L2TP) with VPN tunnels.

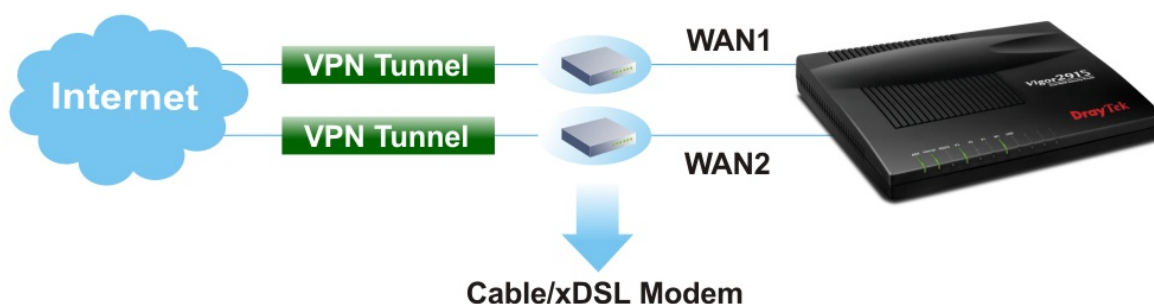

The object-based design used in SPI (Stateful Packet Inspection) firewall allows users to set firewall policy with ease. CSM (Content Security Management) provides users control and management in IM (Instant Messenger) and P2P (Peer to Peer) more efficiency than before. In addition, DoS/DDoS prevention and URL/Web content filter strengthen the security outside and control inside.

Vigor2915 series supports USB interface for connecting USB printer to share printing function, 3G/4G USB modem for network connection, or connectivity for network FTP service.

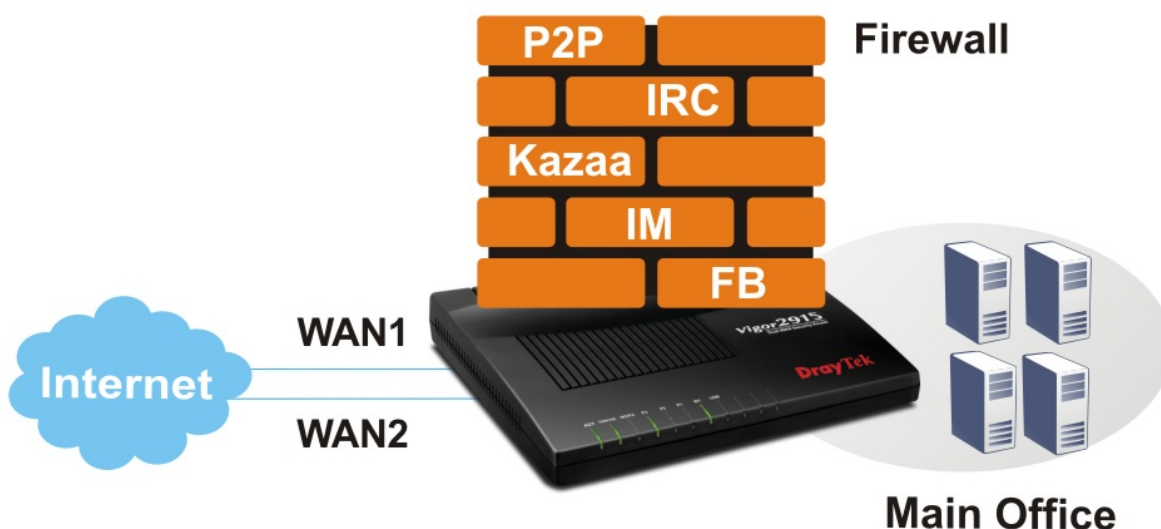

2. Package Content

Take a look at the package content. If there is anything missed or damaged, please contact DrayTek or dealer immediately.



Vigor router

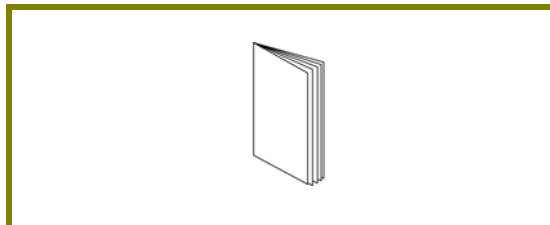

Quick Start Guide

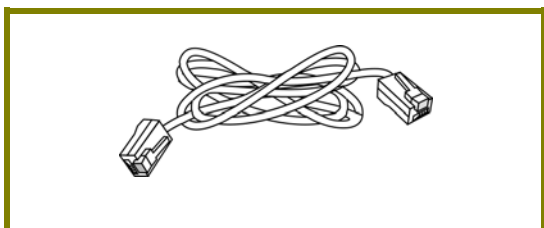

RJ-45 Cat-5 Ethernet Cable

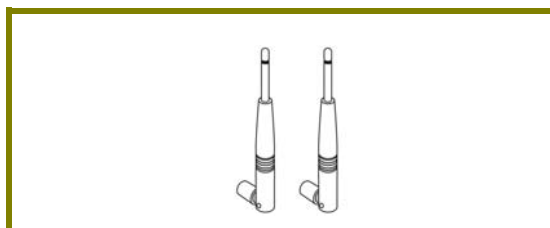

Antenna x 2

The type of the power adapter depends on the country that the router will be installed. * The maximum power consumption is **12 Watts**.

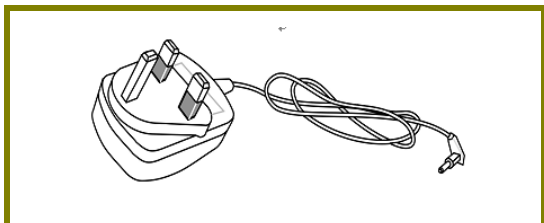

UK-type Power Adapter

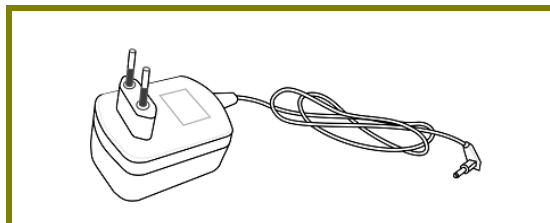

EU-type Power Adapter

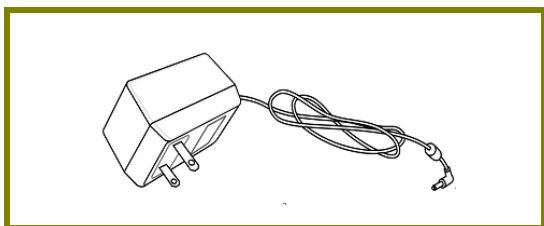

USA/Taiwan-type Power Adapter

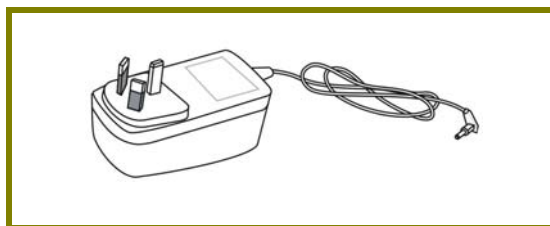

AU/NZ-type Power Adapter

3. Panel Explanation

3.1 Vigor2915ac

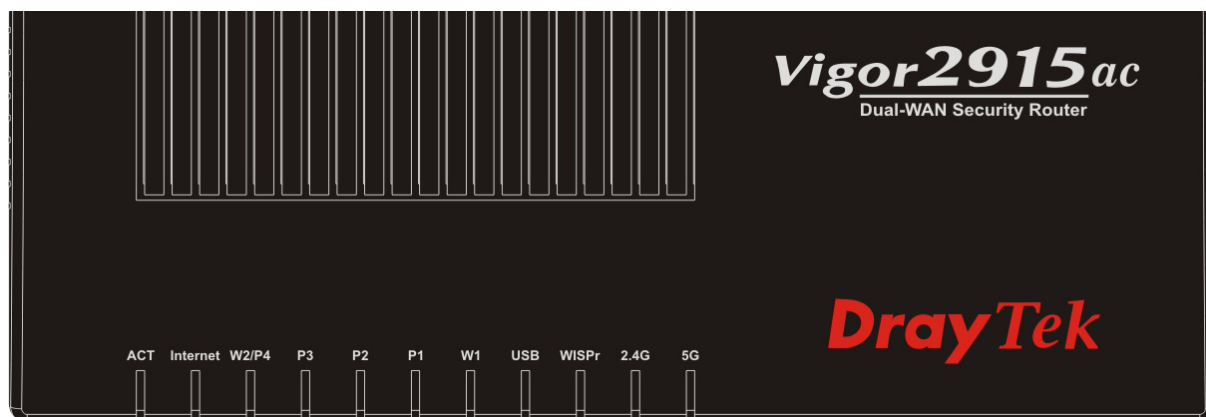

LED	Status	Explanation
ACT	Blinking	The router is powered on and running normally.
	Off	The router is powered off.
Internet	On	Internet connection is ready.
	Off	Internet connection is not ready.
	Blinking	The data is transmitting.
W2/P4	On	The WAN/LAN port is connected.
	Off	The WAN/LAN port is disconnected.
	Blinking	The data is transmitting.
P3~P1	On	The LAN port is connected.
	Off	The LAN port is disconnected.
	Blinking	The data is transmitting.
W1	On	The WAN port is connected.
	Off	The WAN port is disconnected.
	Blinking	The data is transmitting.
USB	On	USB device is connected and ready for use.
	Blinking	The data is transmitting.
WISPr	On	Wi-Fi WAN connected.
	Off	Wi-Fi WAN disconnected.
	Blinking	The data is transmitting.
2.4G/5G	On	Wireless access point with bandwidth of 2.4GHz/5GHz is ready.
	Blinking	It will blink slowly while wireless traffic goes through. ACT and WLAN LEDs blink quickly and simultaneously when WPS is working, and will return to normal condition after two minutes. (You need to setup WPS within 2 minutes.)

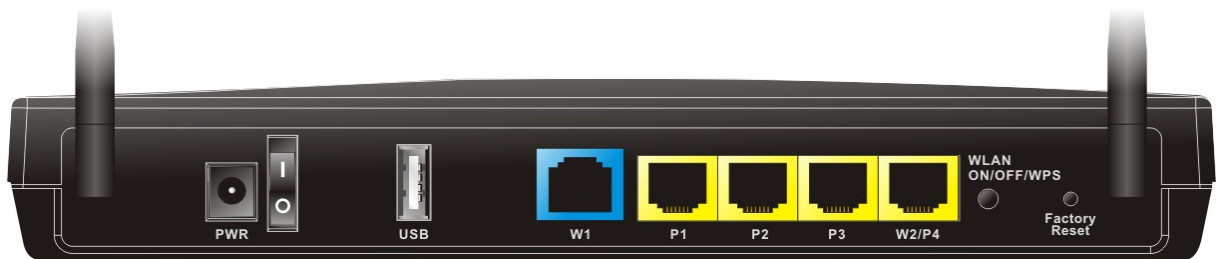

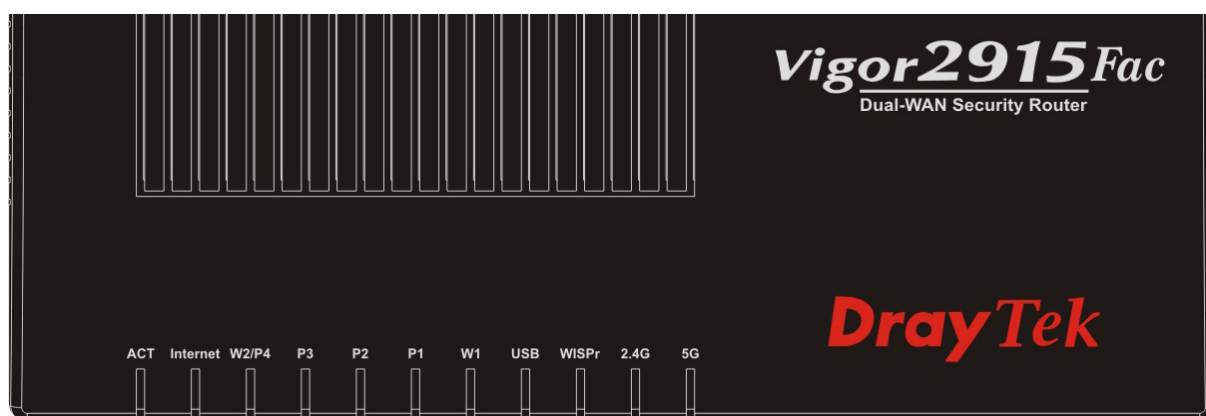

Interface	Description
PWR	Connector for a power cord.
ON/OFF	Power Switch.
USB	Connector for a USB device (for 3G/4G USB Modem or printer or Environmental Thermometer).
W1	Connector for local network devices or modem for accessing Internet.
P1~P3	Connectors for local network devices.
W2/P4	The function of this connector is adjustable and controlled by web user interface. It can perform the job as a WAN port (for accessing Internet) or as a LAN port (for local network devices).
Wireless LAN ON/OFF/WPS	Press "Wireless LAN ON/OFF/WPS" button once to wait for client device making network connection through WPS. Press "Wireless LAN ON/OFF/WPS" button twice to enable (WLAN LED on) or disable (WLAN LED off) wireless connection.
Factory Reset	Restore the default settings. Usage: Turn on the router (ACT LED is blinking). Press the hole and keep for more than 5 seconds. When you see the ACT LED begins to blink rapidly than usual, release the button. Then the router will restart with the factory default configuration.

3.2 Vigor2915Fac

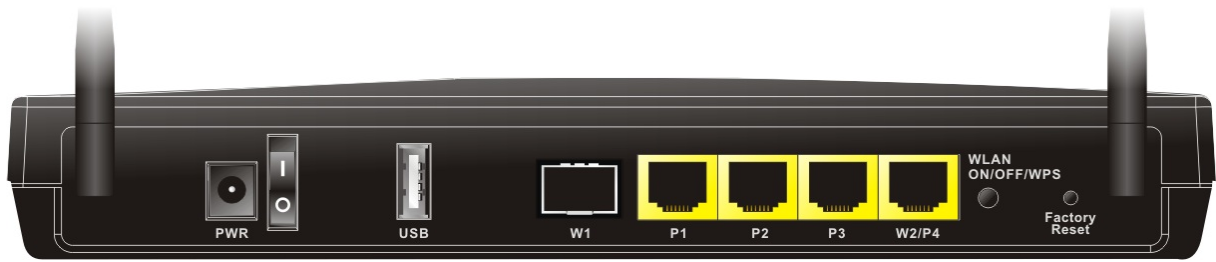

LED	Status	Explanation
ACT	Blinking	The router is powered on and running normally.
	Off	The router is powered off.
Internet	On	Internet connection is ready.
	Off	Internet connection is not ready.
	Blinking	The data is transmitting.
W2/P4	On	The WAN/LAN port is connected.
	Off	The WAN/LAN port is disconnected.
	Blinking	The data is transmitting.
P3~P1	On	The LAN port is connected.
	Off	The LAN port is disconnected.
	Blinking	The data is transmitting.
W1	On	SFP module is plugged and the fiber link is up.
	Off	SFP module is unplugged or the fiber link is down.
	Blinking	The data is transmitting.
USB	On	USB device is connected and ready for use.
	Blinking	The data is transmitting.
WISPr	On	Wi-Fi WAN connected.
	Off	Wi-Fi WAN disconnected.
	Blinking	The data is transmitting.
2.4G/5G	On	Wireless access point with bandwidth of 2.4GHz/5GHz is ready.
	Blinking	It will blink slowly while wireless traffic goes through. ACT and WLAN LEDs blink quickly and simultaneously when WPS is working, and will return to normal condition after two minutes. (You need to setup WPS within 2 minutes.)



Interface	Description
PWR	Connector for a power cord.
ON/OFF	Power Switch.
USB	Connector for a USB device (for 3G/4G USB Modem or printer or Environmental Thermometer).
W1	Fiber connection (1G) for accessing the Internet. 
P1~P3	Connectors for local network devices.
W2/P4	The function of this connector is adjustable and controlled by web user interface. It can perform the job as a WAN port (for accessing Internet) or as a LAN port (for local network devices).
Wireless LAN ON/OFF/WPS	Press "Wireless LAN ON/OFF/WPS" button once to wait for client device making network connection through WPS. Press "Wireless LAN ON/OFF/WPS" button twice to enable (WLAN LED on) or disable (WLAN LED off) wireless connection.
Factory Reset	Restore the default settings. Usage: Turn on the router (ACT LED is blinking). Press the hole and keep for more than 5 seconds. When you see the ACT LED begins to blink rapidly than usual, release the button. Then the router will restart with the factory default configuration.

4. Hardware Installation

This section will guide you to install the router through hardware connection and configure the router's settings through web browser.

Before starting to configure the router (taking Vigor2915ac for example), you have to connect your devices correctly.

4.1 Network Connection

1. Connect the cable Modem/DSL Modem/Media Converter to any WAN port of router with Ethernet cable (RJ-45).
2. Connect one end of an Ethernet cable (RJ-45) to one of the LAN ports (P1~P3) of the router and the other end of the cable (RJ-45) into the Ethernet port on your computer.
3. Connect one end of the power cord to the router's power port on the rear panel, and the other side into a wall outlet.
4. Power on the device by pressing down the power switch on the rear panel.
5. The system starts to initiate. After completing the system test, the ACT LED will light up and start blinking.

(For the detailed information of LED status, please refer to section 3. Panel Explanation)

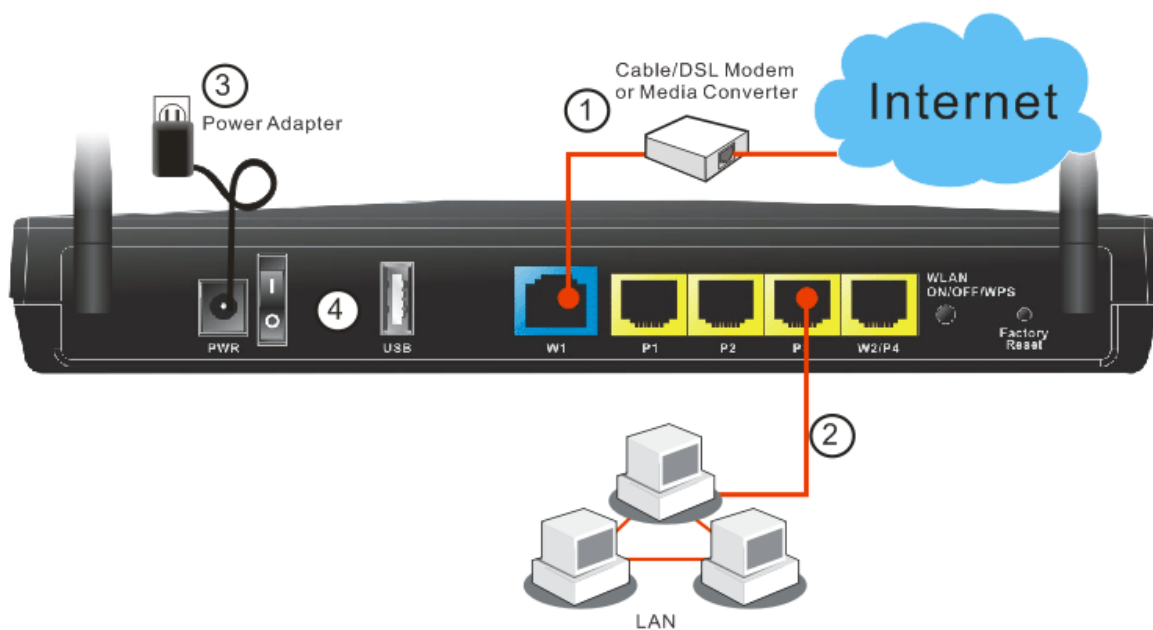

4.2 Wall-Mounted Installation

Vigor router has keyhole type mounting slots on the underside.

1. A template is provided on the Vigor router packaging box to enable you to space the screws correctly on the wall.
2. Place the template on the wall and drill the holes according to the recommended instruction.
3. Fit screws into the wall using the appropriate type of wall plug.

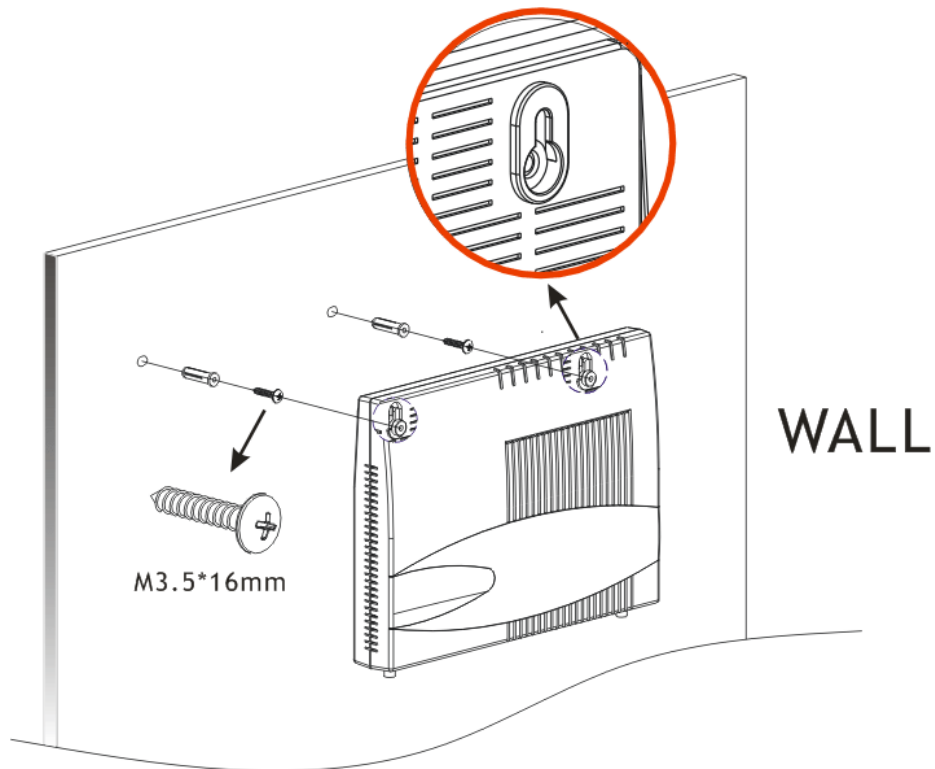

Note

The recommended drill diameter shall be 6.5mm (1/4").

4. When you finished about procedure, the router has been mounted on the wall firmly.

5. Software Configuration

To access Internet, please finish basic configuration after completing the hardware installation.

The **Quick Start Wizard** is designed for you to easily set up your router for Internet access. You can directly access the **Quick Start Wizard** via Web Configurator.

1. Make sure your PC connects to the router correctly.



Note

You may either simply set up your computer to get IP dynamically from the router or set up the IP address of the computer to be the same subnet as the **default IP address of Vigor router 192.168.1.1**. For the detailed information, please refer to the later section - Trouble Shooting of the guide.

2. Open a web browser on your PC and type **http://192.168.1.1**. A pop-up window will open to ask for username and password. Please type "admin/admin" as the Username/Password and click **Login**.

DrayTek **Vigor2915 Series**

Login

Username

Password

Login

Security Warning: You are logging in without encryption which is not recommended. To login securely [click here](#).

Copyright © 2000-2019 DrayTek Corp. All Rights Reserved.



Note

If you fail to access to the web configuration, please go to "Trouble Shooting" for detecting and solving your problem.

- Now, the Main Screen will pop up. Click Wizards>>Quick Start Wizard.

DrayTek Vigor2915 Series

Dashboard

Auto Logout | IR6

Wizards Online Status

Search menu

WAN
LAN
Hotspot Web Portal
Routing
NAT
Hardware Acceleration
Firewall
User Management
Objects Setting
CSM
Bandwidth Management
Applications
VPN and Remote Access
Certificate Management
Wireless LAN (2.4 GHz)
Wireless LAN (5 GHz)
USB Application
System Maintenance
Diagnostics

Central Management
External Devices

MyVigor Services
Product Registration
Service Status

All Rights Reserved.

Admin mode
Status: Ready

System Information

Model Name	Vigor2915ac	System Up Time	0:06:17
Router Name	DrayTek	Current Time	Sat Jan 01 2000 00:05:53
Firmware Version	4.0.5	Build Date/Time	Nov 21 2019 17:39:01
LAN MAC Address	00-1D-AA-95-B7-3C		

Quick Access

System Status
Dynamic DNS
TR-069
User Management
IM/POP Block
Schedule
System / Mail Alert
LDAP
RADIUS
Firewall Object Setting
Data Flow Monitor

IPv4 LAN information

IP Address	DHCP	IP Address	DHCP
LAN1 192.168.1.1/24	v	LAN2 192.168.2.1/24	v
LAN3 192.168.3.1/24	v	LAN4 192.168.4.1/24	v
IP Routed Subnet 192.168.0.1/24	v		

IPv4 Internet Access

Line / Mode	IP Address	MAC Address	Up Time
WAN1 Ethernet / DHCP Client	Disconnected	00-1D-AA-95-B7-3D	00:00:00
WAN2 Ethernet / DHCP Client	Disconnected	00-1D-AA-95-B7-3E	00:00:00

Interface

Interface	Connected
WAN	Connected: 0
LAN	Connected: 2
WLAN	Connected: 0
WLAN5G	Connected: 0

Security

VPN	Connected : 0	Remote Dial-in User / LAN to LAN
MyVigor	Activate : 0	
DoS	Attack Detected :	
RootCA		

System Resource

Current Status	CPU Usage:	1%
	Memory Usage:	77%



Note

The home page will change slightly in accordance with the router you have.

- Enter the login password on the field of New Password and retype it on the field of Confirm Password. Then click Next to continue.

Quick Start Wizard

Enter login password

Please enter an alpha-numeric string as your Password (Max 23 characters).

Old Password	<input type="password" value="*****"/>
New Password	<input type="password" value="*****"/>
Confirm Password	<input type="password" value="*****"/>

Hint: If you want to keep the password unchanged, leave the password blank and press "Next" button to skip this process.

5. On the next page as shown below, please select the WAN interface that you use. Then click **Next** for next step.

Quick Start Wizard

WAN Interface

WAN Interface:	WAN1 ▾
Display Name:	<input type="text"/>
Physical Mode:	Ethernet
Physical Type:	Auto negotiation ▾

< Back Next > Finish Cancel

WAN1 (Ethernet/Fiber) and WAN2 (Ethernet) will bring up different configuration page. Here we take WAN2 (Ethernet) as an example.

After choosing WAN2, please specify physical type. Then, click **Next**. On the next page as shown below, please select the appropriate Internet access type according to the information from your ISP. For example, you should select PPPoE mode if the ISP provides you PPPoE interface.

PPPoE

1. Choose **WAN2** as the WAN Interface and click the **Next** button. The following page will be open for you to specify Internet Access Type.

Quick Start Wizard

Connect to Internet

WAN 2

Select one of the following Internet Access types provided by your ISP.

- PPPoE
- PPTP
- L2TP
- Static IP
- DHCP

< Back Next > Finish Cancel

2. Click **PPPoE** as the Internet Access Type. Then click **Next** to continue.

Quick Start Wizard

PPPoE Client Mode

WAN 2
Enter the user name and password provided by your ISP.

Service Name (Optional)	<input type="text" value="CHT"/>
Username	<input type="text" value="84005657@hinet.net"/>
Password	<input type="password" value="*****"/>
Confirm Password	<input type="password" value="*****"/>

3. Please manually enter the Username/Password provided by your ISP. Click **Next** for viewing summary of such connection.

Quick Start Wizard

Please confirm your settings:

WAN Interface:	WAN2
Physical Mode:	Ethernet
Internet Access:	PPPoE

Click **Back** to modify changes if necessary. Otherwise, click **Finish** to save the current settings and restart the Vigor router.

4. Click **Finish**. A page of **Quick Start Wizard Setup OK!!!** will appear. Then, the system status of this protocol will be shown.

Quick Start Wizard Setup OK!

5. Now, you can enjoy surfing on the Internet.

DHCP

1. Choose WAN2 as WAN Interface and click the Next button. The following page will be open for you to specify Internet Access Type.

Quick Start Wizard

Connect to Internet

WAN 2
Select one of the following Internet Access types provided by your ISP.

- PPPoE
- PPTP
- L2TP
- Static IP
- DHCP

2. Click DHCP as the Internet Access type. Simply click Next to continue.

Quick Start Wizard

DHCP Client Mode

WAN 2
If your ISP requires you to enter a specific host name or specific MAC address, please enter it in.

Host Name (optional)

MAC (optional)

3. After finished the settings above, click **Next** for viewing summary of such connection.

Quick Start Wizard

Please confirm your settings:

WAN Interface:	WAN2
Physical Mode:	Ethernet
Internet Access:	DHCP

Click **Back** to modify changes if necessary. Otherwise, click **Finish** to save the current settings and restart the Vigor router.

4. Click **Finish**. A page of **Quick Start Wizard Setup OK!!!** will appear. Then, the system status of this protocol will be shown.

Quick Start Wizard Setup OK!

5. Now, you can enjoy surfing on the Internet.

6. Customer Service

If the router cannot work correctly after trying many efforts, please contact your dealer/DrayTek for further help right away. For any questions, please feel free to send e-mail to support@draytek.com.

Be a Registered Owner

Web registration is preferred. You can register your Vigor router via <http://www.draytek.com>.

Firmware & Tools Updates

Due to the continuous evolution of DrayTek technology, all routers will be regularly upgraded. Please consult the DrayTek web site for more information on newest firmware, tools and documents.

<http://www.draytek.com>